

Product Catalog

2025



Who We Are 3

Our History.....	4
Ordering Information.....	6



Instrumentation & Procedural Products A1

Diagnostic.....	A101
Hand Scaling.....	A201
Instrument Maintenance.....	A301
Procedural.....	A401
Implant Maintenance.....	A501
Restorative.....	A601
Surgical.....	A701
Endodontic.....	A901
Orthodontic.....	A1001



Power B1

Air Polishing.....	B101
Piezo.....	B201
Magneto.....	B301



Infection Prevention & Instrument Management C1

Instrument Management.....	C101
Instrument Reprocessing & Sterilization.....	C201
Personal Protective Equipment.....	C301



Dental Water Management D1

Dental Unit Waterline Management.....	D101
Evacuation Line Cleaning.....	D201
Sterilization Center Water Solutions.....	D301



Nitrous Oxide/ Oxygen Sedation E1

Delivery Options.....	E3
Flowmeters and Manifolds.....	E101
Nasal Masks.....	E201
Scavenging Circuits.....	E301



Operatory Supplies F1

Cotton & Non-Wovens.....	F101
Cups.....	F201
Evacuation Products.....	F301
Operatory Protection.....	F401
Patient Towels & Bibs.....	F501
Tongue Depressors.....	F601
X-Ray Products.....	F701



Surface Disinfectants G1

Intermediate-Level Disinfectants.....	G100
Low-Level Disinfectants.....	G103

Index H1

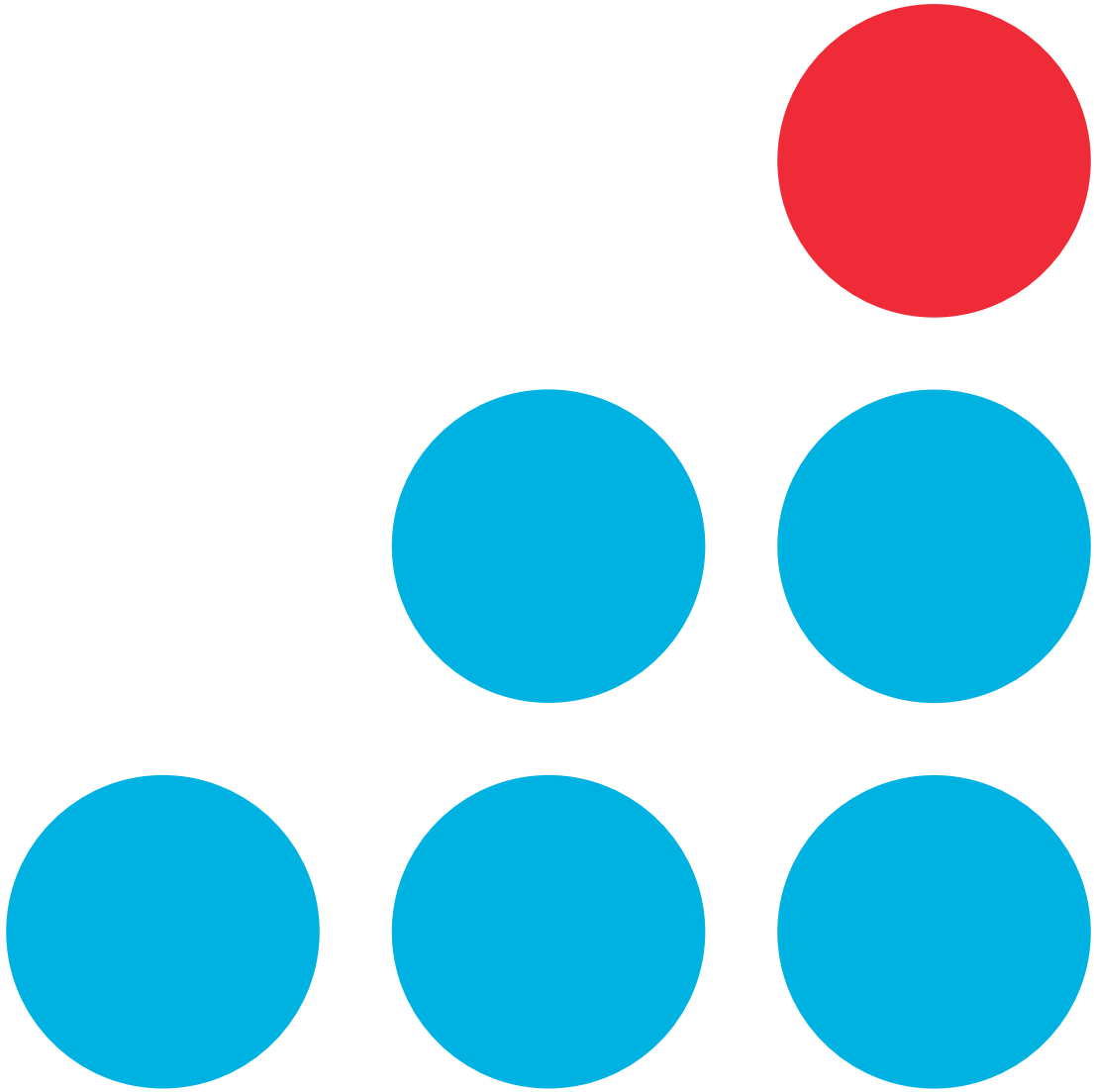

ACCUTRON
Nitrous Oxide/Oxygen Sedation

CROSSTEX

Hu-Friedy

PALMERO
HEALTHCARE



Who We Are

HuFriedyGroup is a global leader in dental instrument manufacturing, infection prevention, and instrument reprocessing workflows, with over 200 years of collective experience in the dental industry.

HuFriedyGroup is the combination of Accutron, Crosstex International, Hu-Friedy, and Palmero Healthcare, united under one roof to deliver the products, services, and solutions that dental professionals need to be **The Best in Practice**.

Together, we bring world-class products, services, education, and communities, resulting in superior clinician performance, clinical outcomes, and safety for clinicians and patients. Headquartered in Chicago, HuFriedyGroup distributes products in more than 100 countries, and the dental division maintains offices in Germany, Italy, China, and Japan.



Our History

Our story dates back to 1908. For over a century, we have been shaping dentistry with innovative products and services designed to help practitioners be **The Best in Practice**. Join us in looking back at our storied history to see every step that has led to our current offering of more than 40,000 products.



**Gracey
Curettes
launched**



**Immunity
Steel™
Instruments
introduced**



**Ultrasonic
Inserts
launched**



**Friends of
Hu-Friedy
online
community
introduced**



**Secure Fit™
Masks &
hand care
products
launched**

1908

1953

1982

1999

2008

1945

1978

1996

2007

2010

**Hu-Friedy
founded
by Hugo
Friedman**



**Crosstex
founded as
disposable
towel/bib
manufacturer**



**IMS™
Cassettes
introduced**

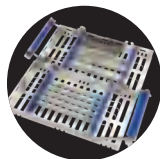

**Orthodontic
line of
instruments
launched**



**Nevi™ Scalers,
named after
legendary
Hu-Friedy artisan
Neville Hammond
introduced**



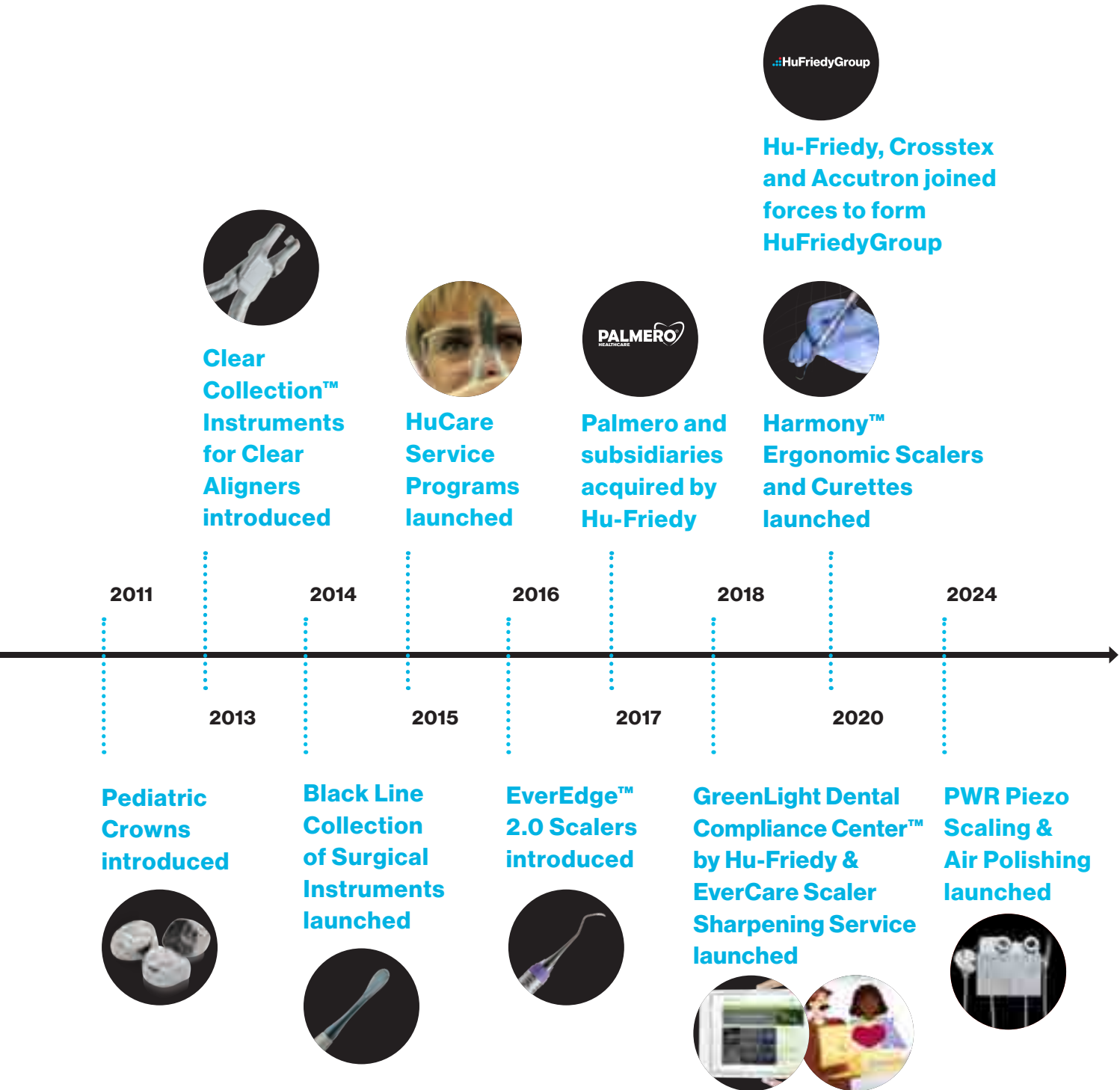



Ordering Information

How to Place an Order

Our instruments may be ordered through an authorized dental distributor. Your dental distributor will take your order and ship the product to you. If you have questions prior to placing an order or would like to place an order for HuFriedyGroup products, please contact our Customer Care Team via the contact information on the following page. We will need to know your distributor preference because your order will automatically be shipped and billed through your dental distributor. If you do not have a dental distributor, an authorized distributor listing is available from our website at HuFriedyGroup.com/wheretobuy/distributors

Customer Care Department

We are proud of our highly trained, qualified and professional Customer Care Team. They are dedicated to helping you meet your needs. Feel free to call a HuFriedyGroup Customer Care Representative when special assistance is needed.

Special Order Instruments

We manufacture an extensive selection of instruments. We welcome the opportunity to manufacture instruments on a special order basis. Instruments that are currently available but are desired in an alternative tip/handle selection or are a special school pattern, are considered special order instruments. Price quotations are available upon request. Submit all special order requests to HuFriedyGroup Customer Care at care@hu-friedy.com. All special order instruments are the property of Hu-Friedy.

Custom Design Instruments (Hu-Friedy Brand Only)

We are a leader in the development, manufacturing and distribution of quality dental instruments as well as products and services related to their use, maintenance and management. We will be pleased to review and provide a quote for custom designed instruments if we can meet your needs. Minimums may be required. All custom designs remain the property of

HuFriedyGroup. To receive a quotation for a custom instrument, please provide: 1) An actual sample and/or a detailed written description that includes all dimensions and measurements. For example: bend angle(s), point width(s), length(s), radius(radii), bevel angle(s), handle design, special material requirements, etc. 2) Provide the name and phone number of your dental distributor. This information will be used to prepare a price quotation. Pre-payment of an initial prototype fee and written approval of the price quotation is required to begin production. All prototype set-up fees are non-refundable. Subsequent orders (more than two years) after the initial order are subject to additional prototyping charges. All custom designs are the property of HuFriedyGroup

HuFriedyGroup Guarantee

Any HuFriedyGroup product that fails as a result of material defect or poor workmanship will be repaired or replaced at no charge. We cannot be responsible for the performance or replacement of

any HuFriedyGroup instrument that has been tampered with, modified, retipped, or refitted in any manner. See **HuFriedyGroup.com/services/warranties** full product warranty details.

Returns, Repair & Reconditioning

Complete service for HuFriedyGroup instruments and IMS™ Cassettes is available in our Chicago facility. Please contact us with any questions or concerns regarding HuFriedyGroup instruments. Call 1-888-TEC-TECH (1-888-832-8324) and you will automatically be connected with the HuFriedyGroup Technical Service Representative who covers your area. All returns should be sent to: HuFriedyGroup Technical Service 3232 N. Rockwell St., Chicago, IL 60618.

For the repair and service of HuFriedyGroup EMS products call 1-888-456-7895 or email **hf-ems@hu-friedy.com**.

No Retipping

We do not repoint or retip instruments. To do so would

compromise the structural integrity of the instrument and our quality standards. In addition, there is a high degree of potential risk to all parties inherent in such a service. Therefore, retipping or repointing instruments will void the warranty HuFriedyGroup offers.

Canadian Sales

Note: Some of the devices and/or products advertised may not be licensed for sale in accordance with Canadian law.

How to Contact HuFriedyGroup (U.S., Canada & International)

1-773-975-6100

HuFriedyGroup.com

Customer Care

1-800-HuFriedy
(1-800-483-7433)

Fax: 1-800-729-1299 or
1-773-975-1683

care@hu-friedy.com

Schools & Institutions

1-877-321-HFED
(1-877-321-4333)

Fax: 1-866-434-3576

schools@hu-friedy.com

Government Team

government@hu-friedy.com

Technical Service

1-888-TEC-TECH
(1-888-832-8324)

Fax: 1-773-868-3544

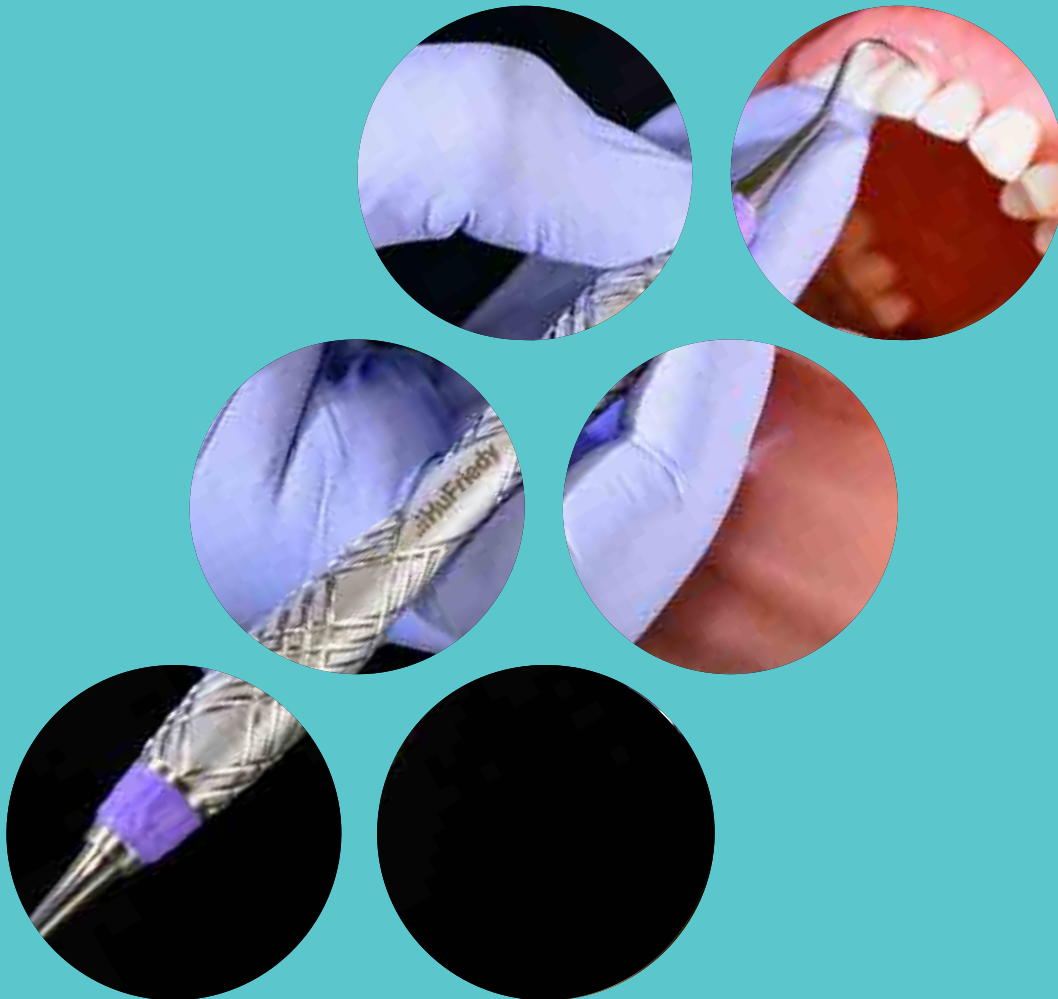

*Compliance = Compliance with current EPA potable water standard of <500 CFU/mL.

Not all instruments are true to size

Note: some of the devices, products, and/or programs advertised may not be licensed for sale outside the United States. Contact your local sales or customer care representative for availability details. For full product warranty details, please visit [HuFriedyGroup.com/services/warranties](https://www.hufriedy.com/services/warranties)

The contents of this catalog including, but not limited to, all text, photographs and graphics, are the sole and exclusive property of Hu-Friedy Mfg. Co., LLC its affiliates or related companies and may not be copied, reproduced or distributed without prior written permission.

Hu-Friedy Mfg. Co., LLC, 1666 E. Touhy Ave., Des Plaines, IL 60018 | [HuFriedyGroup.com](https://www.hufriedy.com)

All company and product names are trademarks of Hu-Friedy Mfg. Co., LLC its affiliates or related companies, unless otherwise noted. Aspen Surgical® and Bard-Parker® are registered trademarks of Aspen Surgical Products, Inc. Beaver® is a registered trademark of Beaver-Visitec International (US), Inc. Mylar® brand is a registered trademark owned by Dupont Teijin Films for a specific family of products made from the resin Polyethylene Terephthalate (PET).



Instrumentation & Procedural Products

Since 1908, we have been and continue to be a global leader in dental instrument manufacturing. We are your go-to destination for hand scaling, orthodontics, surgical instrumentation, and more. Be **The Best in Practice** and achieve superior clinical outcomes with our instrumentation and procedural product portfolio.

Diagnostic	A101
Hand Scaling	A201
Instrument Maintenance	A301
Procedural	A401
Implant Maintenance	A501
Restorative	A601
Surgical	A701
Endodontic	A901
Orthodontic	A1001

Handle Options	A102
Single-End Handles	A102
Double-End Handles	A103
Probes	A104
Colorvue™ Probes	A104
Colorvue™ Biotype Probes	A105
Colorvue™ Perioscreen™ Probes	A106
Single-End Probes	A106
Novatech Probes	A108
Nabers Probes	A109
Screening Probes	A109
Double-End Probes	A110
EFP Probes	A110
Explorers	A111
Single-End Explorers	A111
Double-End Explorers	A113
XTS™ Explorers	A114
Expros	A115
Mirror Handles	A118
Cone Socket	A118
European Simple Stem	A119
Mirror Heads	A120
HD Black Line Mirrors	A120
HD Mirrors	A122
Rhodium Mirrors	A123
HVE Mirror Connect	A123
Dressing Pliers	A124

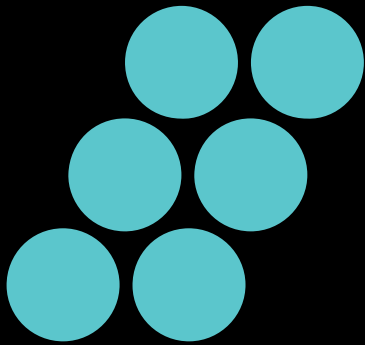

Diagnostic

High quality, durable and long-lasting diagnostic instruments are vital components in procedural set-ups. Our selection of Qulix coated steel probes, Colorvue™ resin probes, Duraspond™ Explorers, and HD and Black Line Mirrors help ensure you have the instruments you need for optimal diagnosis and treatment.



Handle Options

Our diagnostic instruments, including Probes, Explorers, and Expos, come in a variety of handle options. These instruments come either single or double end with four handle options headlined by our popular #6 Satin Steel™ Handle.

Single-End Handles

#6 Satin Steel™ Handle



#7 Satin Steel™ Colours Handle



#8 ResinEight™ Handle



#30 Round Handle



Double-End Handles

#6 Satin Steel™ Handle



#7 Satin Steel™ Colours Handle



#8 ResinEight™ Handle



#31 Round Handle





Probes

Qulix Probes are coded with accurate, smooth black markings, which will not chip, flake, or fade. Colorvue™ Probes feature a vivid markings for enhanced contrast intraorally.



Learn more about our [Probes](#).

Colorvue™ Probes

Colorvue probes feature a vivid yellow or white tip with black markings for enhanced contrast to intraoral structures in both natural and implant dentitions. Optimal flexibility and a rounded tip provide greater patient comfort and acceptability. The probe tips are made with resin, which makes them safe for use with implants and feature a twist-on design for easy replacement of worn tips.



Colorvue is a safe and effective choice for assessing peri-implant health.²



#12 Colorvue™ Probe Tips
12 tips (3-6-9-12) **PCV12PT**

#12 Colorvue™ Probe Kit
1 Handle + 7 tips (3-6-9-12) **PCV12KIT6**
2 Handles + 12 tips (3-6-9-12) **PCV12KIT12**



#UNC12 Colorvue™ Probe Tips
12 tips (1-2-3-4-5-6-7-8-9-10-11-12) **PCVUNC12PT**

#UNC12 Colorvue™ Probe Kit
1 Handle + 7 tips (1-2-3-4-5-6-7-8-9-10-11-12) **PCVNCKIT6**
2 Handles + 12 tips (1-2-3-4-5-6-7-8-9-10-11-12) **PCVNCKIT12**



#11 Colorvue™ Probe Tips
12 tips (3-6-8-11) **PCV11PT**

#11 Colorvue™ Probe Kit
1 Handle + 7 tips (3-6-8-11) **PCV11KIT6**
2 Handles + 12 tips (3-6-8-11) **PCV11KIT12**



Colorvue™ Oxford Probe Tips
12 tips (1-2-3-4-5-6-7-8-9-10-11-12-13-14-15) **PCVO12PT**

1) Colorvue PerioScreen tips sold separately.

2)©Montage Media 2005. Excerpts from white paper on implant maintenance. Rethman M. Hu-Friedy Mfg. Co., LLC. September 2010.



Williams Colorvue™ Probe Tips
 12 tips (1-2-3-5-7-8-9-10) **PCVWPT**

Williams Colorvue™ Probe Kit
 1 Handle + 7 tips (1-2-3-5-7-8-9-10) **PCVWKIT6**



Goldstein Colorvue™ Probe Tips
 12 tips (1/2mm increments up to 3mm, then 1mm increments up to 13mm) **PPSG12PT**

Goldstein Colorvue™ Probe Kit
 1 Handle + 7 tips (1/2mm increments up to 3mm, then 1mm increments up to 13mm) **PPSGKIT6**



Colorvue™ Probe Handle
 #6 Handle **PH6**



Colorvue™ Double End Probe
 1 end UNC15 Qulix Probe and other end for any Colorvue™ Probe tip (Colorvue™ Tips sold separately) **PHO6**



Colorvue™ Oxford Probe Kit
 Double end handle with 1 UNC15 Qulix probe and 6 UNC15 removable tips **PCVOKIT6**

Colorvue™ Biotype Probes

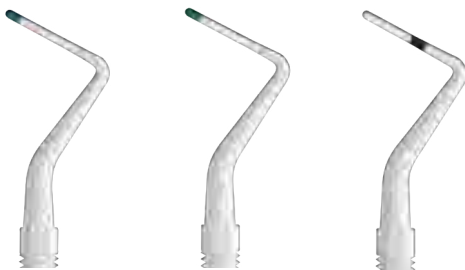

Colorvue™ Biotype Probes
 12 Blue tips **PBTPB**
 12 Green tips **PBTPG**
 12 White tips **PBTPW**

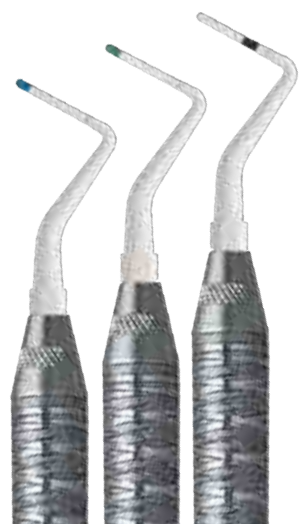

Colorvue™ Biotype Probes Kit
 3 Handles + 4 each Green, Blue and White tips **PBTPKIT12**



Colorvue™ Perioscreen™ Probes



#10 Perioscreen™ Probe Tips	
12 tips (3-5-7-10)	PPS10PT

#10 Perioscreen™ Probe Kits	
1 Handle + 7 tips (3-5-7-10)	PPS10KIT6
2 Handles + 12 tips (3-5-7-10)	PPS10KIT12
1 Handle +1 tip (3-5-7-10)	PPSPROMO10



#12 Perioscreen™ Probe Tips	
12 tips (3-6-9-12)	PPS12PT

#12 Perioscreen™ Probe Kits	
1 Handle + 7 tips (3-6-9-12)	PPS12KIT6
2 Handles + 12 tips (3-6-9-12)	PPS12KIT12
1 Handle +1 tip (3-6-9-12)	PPSPROMO12

Single-End Probes

Used to assess periodontal pocket depths, attachment levels, anatomy configurations, and gingival bleeding.



Qulix SE Probe, 3-6-9-12 Markings	
#6	PCP126
#7	PCP127
#8	PCP128
#30	PCP12



Qulix SE Probe, 3-6-8-11 Markings	
#6	PCP86
#30	PCP8



Qulix SE Probe, 1-2-3-5-7-8-9-10 Markings	
#6	PCP106
#7	PCP107
#8	PCP108
#30	PCP10



Qulix SE Probe, 3-6-8-11 Markings	
#6	PCP116
#7	PCP117
#8	PCP118
#30	PCP11



Qulix SE Probe, 2-4-6-8-10-12 Markings	
#6	PCP26
#30	PCP2



Qulix SE Probe, 3-5-8-10 Markings	
#6	PCP186
#8	PCP188
#30	PCP18



Qulix SE UNC Probe, 1-12 Markings	
#6	PCPUNC126
#7	PCPUNC127
#8	PCPUNC128
#30	PCPUNC12



Qulix SE UNC Probe, 1-15 Markings	
#6	PCPUNC156
#7	PCPUNC157
#8	PCPUNC158
#30	PCPUNC15



Qulix SE Mich O Probe, 3-6-8 Markings	
#6	PQO6
#30	PQO



Qulix SE Williams Probe 1-2-3-5-7-8-9-10 Markings	
#6	PQW6
#7	PQW7
#8	PQW8
#30	PQW



Qulix SE Mich O Probe 1-2-3-5-7-8-9-10 Markings	
#6	PQOW6
#7	PQOW7
#8	PQOW8
#30	PQOW



Glickman SE Probe 1-2-3-5-7-8-9-10 Markings	
#6	P26G6
#30	P26G



Goldman-Fox Flat SE Probe 1-2-3-5-7-8-9-10 Markings	
#6	PGF6
#30	PGF



Merritt B SE Probe 1-2-3-5-7-8-9-10, Markings	
#6	PMB6
#30	PMB



Maryland Laser Etched SE Probe 1-2-3-5-7-8-9-10 Markings	
#30	PCPMDBIU



Mich O SE Probe, 3-6-8 Markings

#6	PO6
#30	PO



Thin Williams 1-2-3-5-7-8-9-10

#6	POW6
#30	POW



Williams SE Probe 1-2-3-5-7-8-9-10

#6	PW6
#7	PW7
#8	PW8
#30	PW

Novatech Probes

Unique right angle design for improved adaptability in posterior regions.

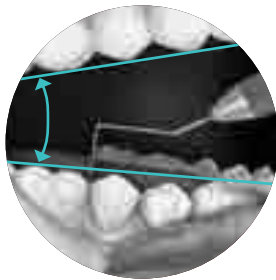

Conventional Probe

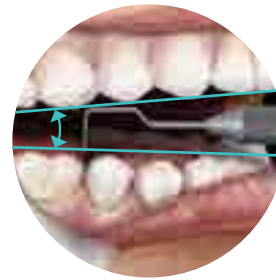

Novatech Probe

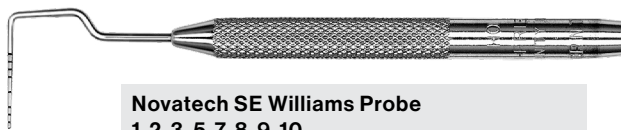

**Novatech SE Williams Probe
1-2-3-5-7-8-9-10**

#30	PCPNT2W
-----	----------------



Novatech SE Probe 3-6-8-11 Markings

#30	PCPNT11
-----	----------------



Novatech SE Probe, 3-6-9-12 Markings

#6	PCPNT26
#7	PCPNT27
#8	PCPNT28
#30	PCPNT2



Novatech SE Probe, UNC 1-12

#6	PCPNT126
#30	PCPNT12



Novatech SE Probe, UNC 1-15

#6	PCPNT156
#30	PCPNT15



**Novatech Thin Williams Probe
1-2-3-5-7-8-9-10 Markings**

#6	PCPNTOW6
#8	PCPNTOW8
#30	PCPNTOW



Nabers Probes



#1N Nabers DE Probe

#6	P1N6
#31	P1N

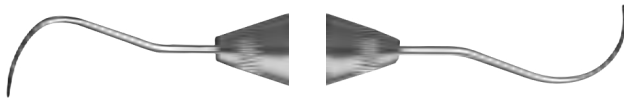

#2N Nabers DE Probe

#6	P2N6
#31	P2N



#2 Color Coded Nabers DE Probe 3-6-9-12 Markings

#6	PQ2N6
#7	PQ2N7
#8	PQ2N8
#31	PQ2N

Screening Probes



Qulix UNC15/11.5B DE Screening Probe

#6	P15/11.5B6
#31	PCP15/11.5

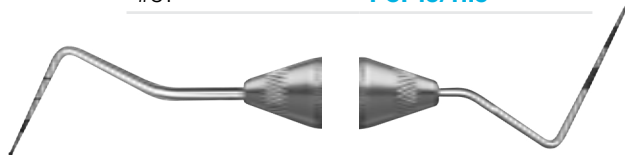

Qulix CP12/11.5B DE Screening Probe

#6	P12/11.5B6
#31	PCP12/11.5

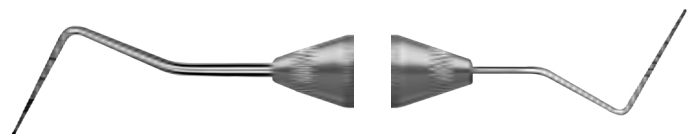

Qulix 11.5B/Thin Williams DE Screening Probe

#6	PQOW11.5B6
#31	PCPQOW11.5



Qulix Novatech Screening Probe, 3.5-5.5-8.5-11.5

#30	PCPNT11.5B
-----	-------------------



Qulix WHO Probe 3.5-5.5-8.5-11.5, Markings

#6	PCP11.5B6
#7	PCP11.5B7
#8	PCP11.5B8
#30	PCP11.5B



Double-End Probes



#3/4 Cattoni DE Probe 3-6-9-12	
#6	P3/46
#31	P3/4

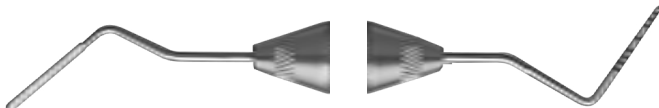

Goldman-Fox Flat/Williams DE Probe	
#6	PGF/W6
#7	PGF/W7
#8	PGF/W8
#31	PGF/W

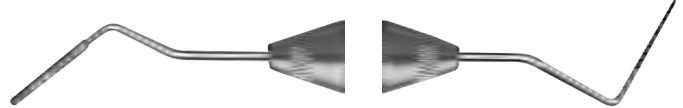

Goldman-Fox Flat/Williams CC DE Probe	
#6	PCPGF/W6
#31	PCPGF/W

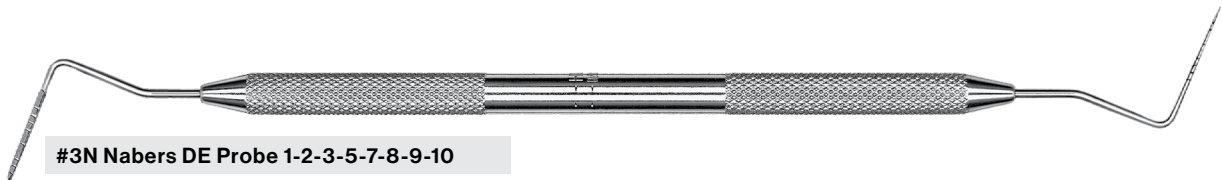

#3N Nabers DE Probe 1-2-3-5-7-8-9-10	
#31	P3N

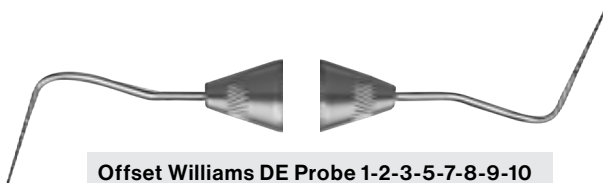

Offset Williams DE Probe 1-2-3-5-7-8-9-10	
#6	PWD6
#31	PWD

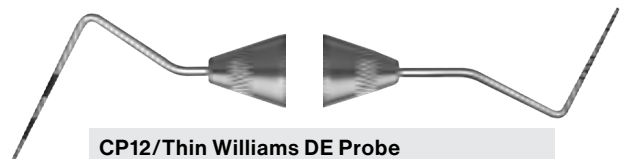

CP12/Thin Williams DE Probe	
#6	PCP12/QOW6

EFP Probes



EFP Probe Single Ended	
#6	PCPS36
Smooth	PCP3CH



EFP Probe with #23 Explorer	
#6	X23/PS36



Explorers

Explorers are crafted from Duraspond™ Steel, a specially blended steel alloy which provides flexibility and resilience for precise diagnostic procedures.



Learn more about our [Explorers](#).

Single-End Explorers



#3 SE Explorer	
#6	EXS36
#30	EXS3



#3A SE Explorer	
#6	EXS3A6
#7	EXS3A7
#8	EXS3A8
#30	EXS3A



#6 6.5mm Explorer	
#6	EXS66
#8	EXS68
#30	EXS6



#6A 12mm Explorer	
#6	EXS6A6
#7	EXS6A7
#30	EXS6A



#6L 9mm Explorer	
#6	EXS6L6
#8	EXS6L8
#30	EXS6L



#6XL 12.5mm Explorer	
#30	EXS6XL



#8 SE Explorer	
#6	EXS86
#30	EXS8



#9 SE Explorer	
#6	EXS96
#7	EXS97
#8	EXS98
#30	EXS9



#17 SE Explorer	
#6	EXS176
#30	EXS17



#23 Shepherd's Hook SE Explorer	
#6	EXS236
#7	EXS237
#8	EXS238
#30	EXS23



#TU-17 Wilkins/Tufts SE Explorer	
#6	EXTU176
#8	EXTU178
#30	EXTU17



#54 SE Explorer	
#6	EXS546
#30	EXS54

Double-End Explorers



#1 DE Explorer	
#6	EXD16
#31	EXD1



#2 DE Explorer	
#6	EXD26
#7	EXD27
#8	EXD28
#31	EXD2



#2A Pigtail DE Explorer	
#6	EXD2A6
#31	EXD2A

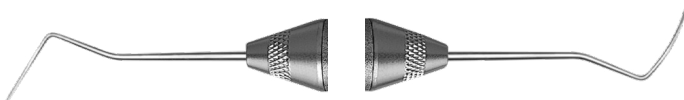

#2H DE Explorer	
#6	EXD2H6
#31	EXD2H



#2R/2L DE Explorer	
#6	EXD2R/2L6
#7	EXD2R/2L7
#31	EXD2R/2L

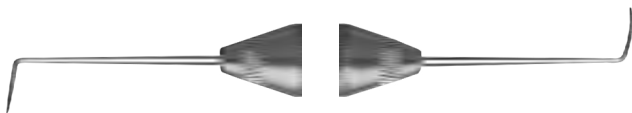

#3 DE Explorer	
#6	EXD36
#31	EXD3



#3CH DE Cow Horn Explorer	
#6	EXD3CH6
#7	EXD3CH7
#8	EXD3CH8
#31	EXD3CH



#3ES DE Explorer	
#6	EXD3ES6
#7	EXD3ES7
#8	EXD3ES8
#31	EXD3ES



#EN1 DE Explorer	
#6	EXDEN16
#31	EXDEN1



#TU-17/23 Wilkins Tufts DE Explorer	
#6	EXTU17/236
#7	EXTU17/237
#8	EXTU17/238
#31	EXTU17/23



Combination #23 Shepherd's Hook and #6 DE Explorer	
#6	EX23/66
#31	EX23/6



#5 DE Explorer	
#6	EXD56
#7	EXD57
#8	EXD58
#31	EXD5



Combination #6 and #3 DE Explorer	
#6	EXD66
#31	EXD6

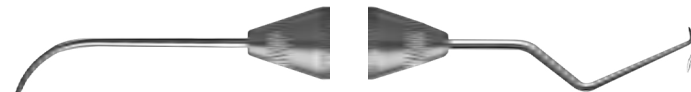

Explorer 3A/TU17	
#6	EX3A/TU176
#31	EX3A/TU17



#11/12 ODU DE Explorer	
#6	EXD11/126
#7	EXD11/127
#8	EXD11/128
#31	EXD11/12



#11/12 ODU After Five DE Explorer	
#6	EXD11/12A6
#7	EXD11/12A7
#8	EXD11/12A8
#31	EXD11/12AF



To correctly adapt the tip of the 11/12 ODU explorer, place the tip interproximally so that the terminal shank is parallel to the tooth surface.

XTS™ Explorers

XTS Explorers feature a non-stick Aluminum Titanium Nitride coating. It is perfect for contouring dental anatomy during composite restorations. The dark coating also improves contrast between tooth and instrument tip.



#2 DE XTS™ Explorer	
#6	EXD2XTS



#3 Cowhorn DE XTS™ Explorer	
#6	EXD3CHXTS



#5 DE XTS™ Explorer	
#6	EXD5XTS

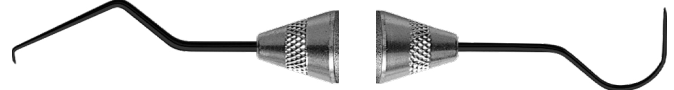

#TU17/23 DE XTS™ Explorer	
#6	EXTU1723XT

Expros

An Expro is excellent for dental examinations and charting, since it combines two critical instruments required for every effective diagnostic setup – an explorer on one end and a probe on the other.



Learn more about our [Expros](#).



#23 /QW William Expro

#6	XP23/QW6
#31	XP23/QW

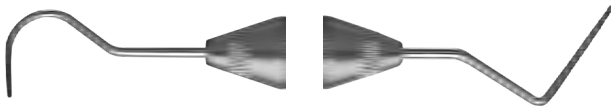

#23/QOW Thin Williams Expro

#6	XP23/QOW6
#7	XP23/QOW7
#8	XP23/QOW8
#31	XP23/QOW

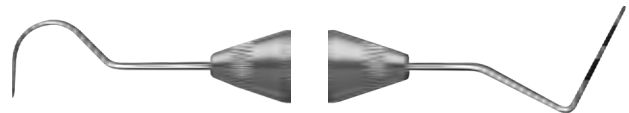

#23/CP-8 Expro

#6	XP23/86
#31	XP23/8

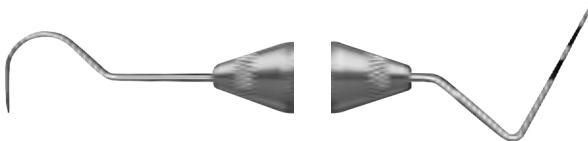

#23/CP-11 Expro

#6	XP23/116
#31	XP23/11

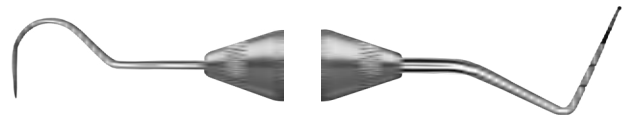

#23/11.5B WHO Style Expro

#6	XP23/11.56
#7	XP23/11.57
#8	XP23/11.58
#31	XP23/11.5B



#23/CP-12 Expro

#6	XP23/126
#7	XP23/127
#8	XP23/128
#31	XP23/12

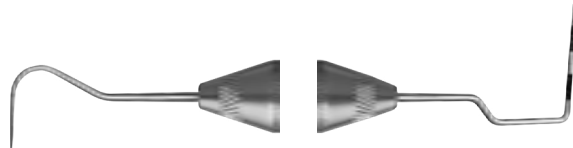

#3/CP12 Novatech Expro

#6	XPNT36
#31	XPNT3



#23/UNC12 Expro

#6	XP23/NC126
#7	XP23/NC127
#8	XP23/NC128
#31	XP23/UNC12

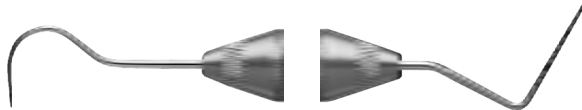

#23/UNC15 Expro

#6	XP23/UNC6
#7	XP23/UNC7
#8	XP23/UNC8
#31	XP23/UNC15

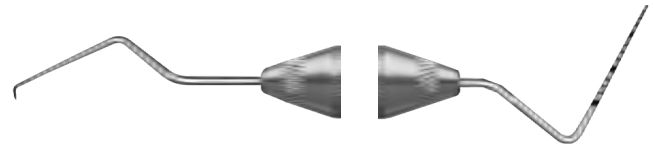

TU17/UNC15 Expro

#6	XPTU17/156
#31	XPTU17/15

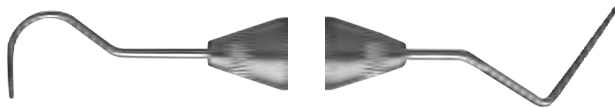

#23/Williams Expro

#6	XP23/W6
#7	XP23/W7
#8	XP23/W8
#31	XP23/W

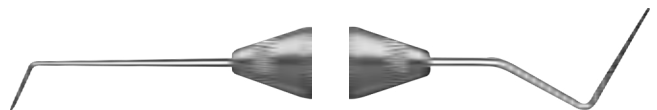

#6/Thin Williams Expro

#6	XP6/OW6
#31	XP6/OW

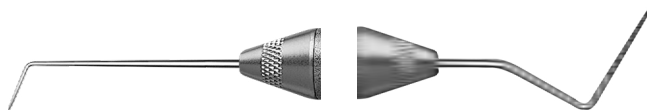

#6/Williams Expro

#6	XP6/W6
#31	XP6/W



#17/Thin Williams Expro

#6	XP17/OW6
#31	XP17/OW

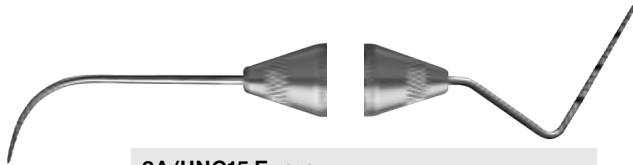

3A/UNC15 Expro
 6 **XP3A/NC156**
 31 **XP3A/UNC15**

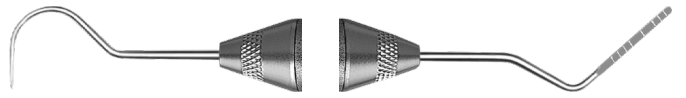

#23/GF (Flat) Expro
 6 **XP23/GF6**
 31 **XP23/GF**

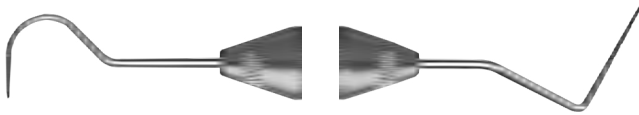

#23/O Michigan Expro
 6 **XP23/O6**
 31 **XP23/O**

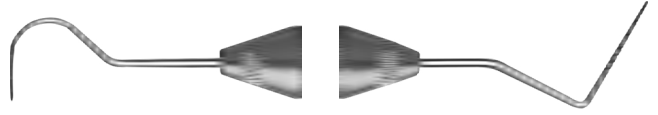

#23/O Thin Williams Expro
 6 **XP23/OW6**
 31 **XP23/OW**

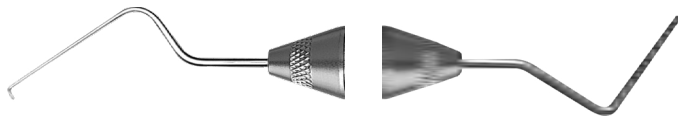

#20F/O Thin Williams Expro
 6 **XP20F/QOW6**
 31 **XP20FQOW**



#23 Explorer + Colorvue™ Probe
 #6 **XP23/PH6**

Colorvue™ Tips are sold separately

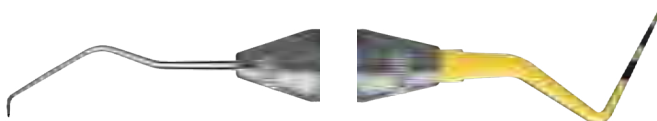

#17 Explorer + Colorvue™ Probe
 #6 **XP17/PH6**

Colorvue™ Tips are sold separately

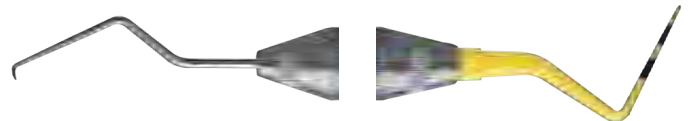

#TU17 Explorer + Colorvue™ Probe
 #6 **XPTU17/PH6**

Colorvue™ Tips are sold separately



Mirror Handles

We provide a variety of mirror handles in both cone socket and European simple stem styles.

Cone Socket

#6 Black Line Cone Socket
Mirror Handle
MH6B



#6 Cone Socket Mirror Handle
MH6



#7 Cone Socket Mirror Handle
MH7



ResinEight™ Cone Socket Mirror Handle
MH8



#24 Cone Socket Mirror Handle
MH24



#1 Cone Socket Mirror Handle
MH1





European Simple Stem

#6 Black Line European Simple Stem
Mirror Handle
MHE6B



#6 European Simple Stem Mirror Handle
MHE6



#7 European Simple Stem Mirror Handle
MHE7



Round European Stem
Mirror Handle
MHO175E

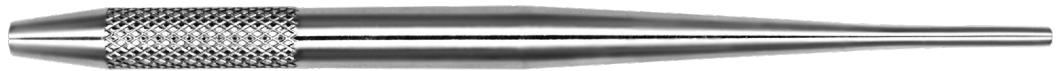



Mirror Heads

Used with nearly every dental procedure, mirrors are a mainstay of procedural set-ups. Our selection of mirror heads provide quality and top-notch visibility for all dental procedures.



Learn more about our [Mirrors Heads](#).

HD Black Line Mirrors

Designed for enhanced performance, our HD Black Line Mirrors are engineered to optimize clinical outcomes by delivering superior visibility throughout any dental procedure. The Diamond Like Carbon (DLC) coating of the handle and mirror frame reduces glare up to 80%!¹ The durable black matte finish in combination with the superior brilliance and color of our proprietary HD Mirror glass facilitates quicker and more accurate visibility of the mouth.



Learn more about our [HD Black Line Mirrors](#).



#5 HD Blackline Single-Sided Mirror	
Cone Socket	MIR5HDB
EU Simple Stem	MIR5HDBE



#5 HD Blackline Double-Sided Mirror	
Cone Socket	MIR5DSHDB
EU Simple Stem	MIR5DSHDBE



WHAT ARE YOU MISSING?

**HD BLACK LINE MIRRORS
REDUCE GLARE UP TO 80%¹**



Visit us online at [HuFriedyGroup.com/HD](https://www.hufriedy.com/HD)

1) When comparing the Hu-Friedy DLC coated mirror head and handle to the Hu-Friedy non-coated stainless-steel mirror head and handle.



HD Mirrors

Our High Definition Mirrors feature a proprietary coating that provides superior brilliance and color for increased visibility in all dental procedures. Also scratch-resistant, our HD Mirrors are the clear choice for optimal patient treatment.



#3 HD Single-Sided Mirror	
Cone Socket	MIR3HD
EU Simple Stem	MIR3HDE



#4 HD Double-Sided Mirror	
Cone Socket	MIR4DSHD
Cone Socket (QTY: 6)	MIR4DSHD6
EU Simple Stem	MIR4DSHDE
EU Simple Stem (QTY: 6)	MIR4DSHD6E



#4 HD Single-Sided Mirror	
Cone Socket	MIR4HD
Cone Socket (QTY: 3)	MIR4HD3
Cone Socket (QTY: 12)	MIR4HD12
EU Simple Stem	MIR4HDE
EU Simple Stem (QTY: 3)	MIR4HD3E
EU Simple Stem (QTY: 12)	MIR4HD12E



#5 HD Double-Sided Mirror	
Cone Socket	MIR5DSHD
Cone Socket (QTY: 6)	MIR5DSHD6
EU Simple Stem	MIR5DSHDE
EU Simple Stem (QTY: 6)	MIR5DSHD6E

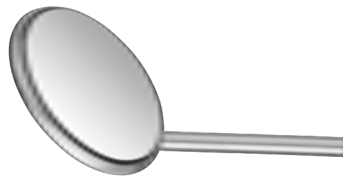

#5 HD Single-Sided Mirror	
Cone Socket	MIR5HD
Cone Socket (QTY: 3)	MIR5HD3
Cone Socket (QTY: 12)	MIR5HD12
EU Simple Stem	MIR5HDE
EU Simple Stem (QTY: 3)	MIR5HD3E
EU Simple Stem (QTY: 12)	MIR5HD12E

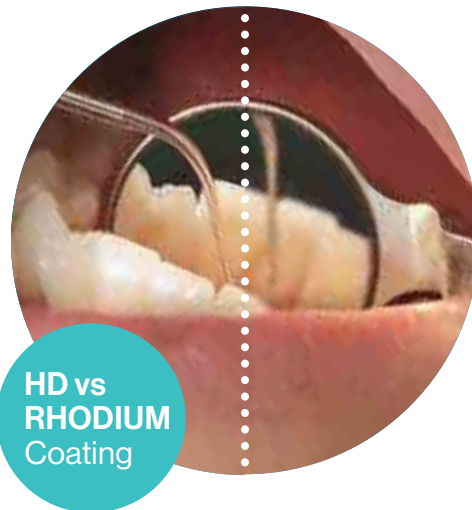

• **Best in Practice Fact**
 • High Definition Mirrors are 38.5% brighter than rhodium and feature a 113% reflection factor.¹

Rhodium Mirrors

Rhodium-coated to resist scratching, our front surface mirrors provide sharp and distortion-free images with a smooth finish for patient comfort.



#4 Front Surface Rhodium Single-Sided Mirror

Cone Socket	MIR4
Cone Socket (QTY: 3)	MIR4/3
Cone Socket (QTY: 12)	MIR4/12
EU Simple Stem (QTY: 12)	M4C



#4 Front Surface Rhodium Double-Sided Mirror

Cone Socket	MIR4DS
Cone Socket (QTY: 3)	MIR4DS/3
Cone Socket (QTY: 6)	MIR4DS/6
EU Simple Stem (QTY: 6)	M4DC



#5 Front Surface Rhodium Single-Sided Mirror

Cone Socket	MIR5
Cone Socket (QTY: 3)	MIR5/3
Cone Socket (QTY: 12)	MIR5/12
EU Simple Stem (QTY: 12)	M5C



#5 Front Surface Rhodium Double-Sided Mirror

Cone Socket	MIR5DS
Cone Socket (QTY: 3)	MIR5DS/3
Cone Socket (QTY: 6)	MIR5DS/6
EU Simple Stem (QTY: 6)	M5DC

HVE Mirror Connect



HVE Mirror Connect
HVEMC



Learn more about our [HVE Mirror Connect](#).

Two Hands with the Same Visibility as Four



Enjoy visibility and function with greater simplicity with our HVE Mirror Connect. Get the benefits of four-handed dentistry without the extra hands. It's perfectly designed to fit any of our #5 double-sided mirror heads.*

* Mirrors sold separately



Dressing Pliers

Used to grasp or transfer materials in and out of the oral cavity, all dressing pliers are made of heavy-gauge, heat-treated stainless steel to ensure long life and precise beak alignment.

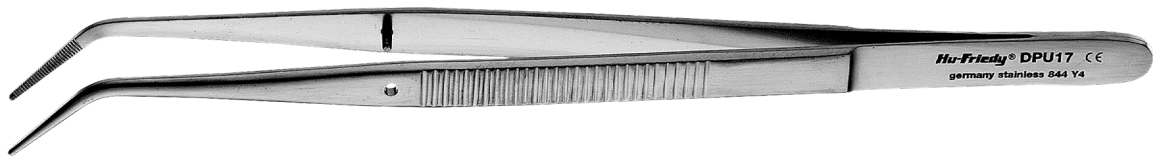

Dressing Pliers, Utility Pick-Up
DPU17

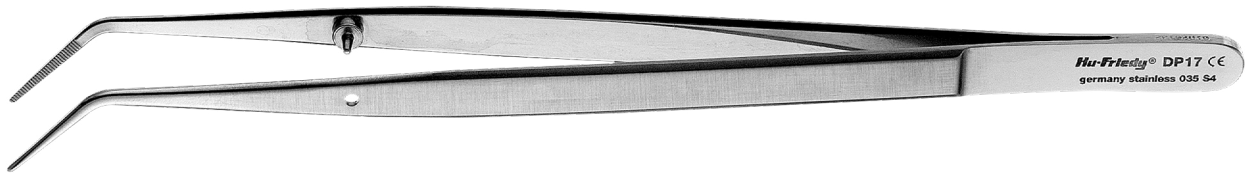

#17 Dressing Pliers
DP17



#18 Dressing Pliers
DP18



#18L Dressing Pliers (Locking)
DP18L



#19 Dressing Pliers
DP19



#2 Dressing Pliers (College)
DP2

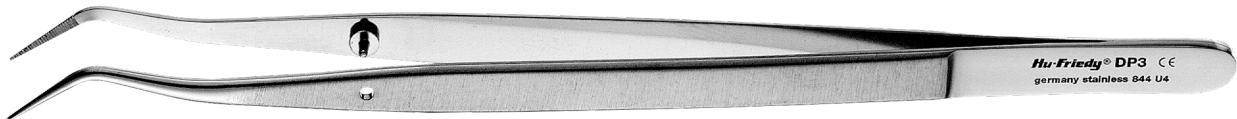

#3 Dressing Pliers
DP3



#317 Dressing Pliers, Smooth Beak
DP317



#318 Foil Dressing Plier Meriam, Serrated
DP318

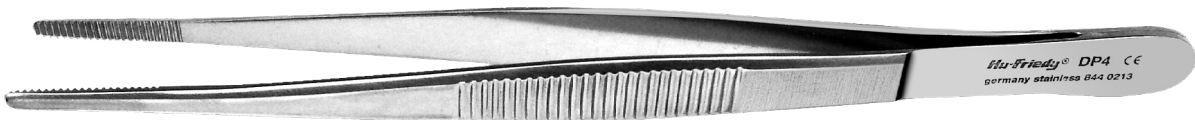

#4 Dressing Pliers
DP4



#1 Dressing Pliers (Perry)
DP1

Periodontal Set-Ups	A202	Sickle Scalers	A228
Procedural Kits	A203	Nevi™ Scalers	A228
Aerosol Mitigation	A203	Anterior Sickle Scalers	A230
EverEdge™ 2.0 Technology	A204	Posterior Sickle Scalers	A232
Handle Options	A205	Jacquette Sickle Scalers	A234
Gracey Curettes	A207	Specialty Scalers	A235
Standard Gracey Curettes	A207	ResinEight™ Colors with EverEdge 2.0 Technology	A236
Gracey After Five™ Curettes	A210	Points of Performance	A236
Gracey Mini Five™ Curettes	A212	ResinEight™ Colors Guide	A237
Gracey Micro Mini Five™ Curettes	A214	Scaler and Curette Sets	A238
Pattison Gracey Lite Curettes	A215	McCall Scalers and Curettes	A238
Vision Curvettes	A216	Goldman-Fox Scalers and Curettes	A239
BioGent Curettes	A217	Cattoni Scalers	A240
Gracey Curettes Reference	A218	Files and Hoes	A241
Design Comparisons	A219	Hoe Scalers	A241
Universal Curettes	A220	File Scalers	A242
Langer Curettes	A220	Chisels	A243
Columbia Curettes	A222	DiamondTec™ File Scalers	A243
Barnhart Curettes	A223	Empowerment Kit	A244
Furcation Curettes	A224	Empowerment Scalers and Curettes	A244
Standard Universal Curettes	A225		

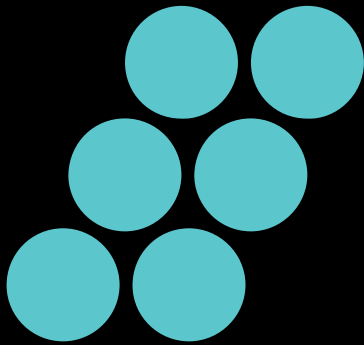

Hand Scaling

Our hand scalers are made from the finest grade stainless steel to ensure superior performance and longevity. With the largest selection of tip designs in the industry, we also offer a variety of innovative and ergonomic handle designs including the new line of Harmony™ Ergonomic Scalers and Curettes designed with TrueFit™ Technology. And, whether your choice is an EverEdge™ 2.0 Blade with superior edge retention characteristics or the classic Immunity Steel™ Blade, you can be assured that your instruments are meticulously crafted to allow you to be **The Best in Practice.**



Periodontal Set-Ups

Large Prophy Set-Up	
Description	Suggestion
Cassette	IMNX*
Mirror	MIR4DSHD
Explorer	EXD11/126
Probe	PCVOKIT6
Sickle Scalars	SH6/7XE2, SCNEVI4XE2
Universal Curette	SBH5/6XE2
Area Specific Curettes	SG1/2XE2, SG7/8XE2 SG11/12XE2, SG13/14XE2
Implant Scaler	IMPLG1/2T
Dressing Pliers	DP2
Diamond Sharpening Cards	DSCSET

Other Recommended Products:
 Prophy Angle, Suction Tip, Aspirating Syringe, A/W Syringe Tip, IMS™ Cassette Clip, Color-Coded Rings

Small Prophy/Pedodontic/Sealant	
Description	Suggestion
Cassette	IMNX*
Mirror/Handle	MIR4/3, MH6
Explorer	EXD2A
Probe	PCP12/11.5
Sickle Scalars	SH6/7XE2, SCNEVI3XE2
Universal Curettes	SC13/14XE2, SBH5/6XE2

Other Recommended Products:
 Prophy Angle, Suction Tip, Color-Coded Rings, Sharpening Stone SS3C

Periodontal Scaling	
Description	Suggestion
Cassette	IMNX*
Mirror	MIR4DSHD
Explorers	EXD11/12A6, EXTU17/236
Probe	PCP15/11.5, PBTPKIT12
Sickle Scalars	SH6/7XE2, SCNEVI4XE2
After Five™ Curettes and Mini Five™ Curettes	SAS1/2XE2, SAS7/8XE2, SRPG11/12XE2, SRPG13/14XE2, SRPG15/16XE2, SG17/18XE2
Universal Curette	SM17/18XE2
Dressing Pliers	DP2
Diamond Sharpening Cards	DSCSET

Other Recommended Products:
 Prophy Angle, Suction Tip, Aspirating Syringe, A/W Syringe Tip, IMS™ Cassette Clip, Color-Coded Rings

Periodontal Maintenance	
Description	Suggestion
Cassette	IMNX*
Mirror	MIR4DSHD
Explorer	EXD11/12A6
Probe	PPSGKIT6
Sickle Scalars	SH6/7XE2, SCNEVI4XE2
Curettes	SG1/29APXE2, SG11/12APXE2, SG13/149APXE2
Implant Scaler	IMPLG1/2T

Other Recommended Products:
 Prophy Angle, Suction Tip, Color-Coded Rings, Sharpening Stone SS3C

* See Instrument Management Section for exact product code number.

Procedural Kits

Our procedural kits are a compilation of clinicians' most popular procedural set-ups designed for ease of ordering.

Aerosol Mitigation

Many studies have shown that the same clinical outcomes are achieved with hand scaling as with ultrasonics, allowing you to provide enhanced patient care while mitigating aerosol risks. If you are prioritizing hand scaling take advantage of our Aerosol Mitigation Kit, available with or without the HVESolo™ Disposable Evacuation Tips.



Perio Recovery Kit	RECPERIO-KIT
H6/7 Sickle Scaler, #9 Handle	SH6/79E2
204S Posterior Sickle Scaler, #9 Handle	S204S9E2
Barnhart 5/6 Curette, #9 Handle	SBH5/69E2
Gracey 11/12 Standard Curette, #9 Handle	SG11/129E2
Gracey 13/14 Standard Curette, #9 Handle	SG13/149E2

Perio Recovery Kit with HVESolo™ Evacuation Tips	RECPSOLO-KIT
H6/7 Sickle Scaler, #9 Handle	SH6/79E2
204S Posterior Sickle Scaler, #9 Handle	S204S9E2
Barnhart 5/6 Curette, #9 Handle	SBH5/69E2
Gracey 11/12 Standard Curette, #9 Handle	SG11/129E2
Gracey 13/14 Standard Curette, #9 Handle	SG13/149E2
HVESolo™ Disposable Evacuation Tips (2.5" length)	1808S



EverEdge™ 2.0 Technology



As an educator, I always recommend EverEdge™ Instruments to my dental hygiene students. When well maintained, they can be sharpened so quickly and easily. A real advantage of the fine sharp cutting edge is less hand fatigue for the hygienist and better comfort for the patient, so both the clinician and patient can feel the benefits of EverEdge.

Jill Nield Gehrig, RDH, MA
Dean Emeritus, Division of Allied Health

The EverEdge™ 2.0 Blades sharpened very easily and remained sharp with each additional use.

Judith Reid, M.Ed, RDH

Finely-Honed Finish

EverEdge™ scalers are sharp...EverEdge™ 2.0 scalers are even sharper. Using an enhanced finishing process, Our professional artisans are creating edges that are scientifically measured to be over 60% sharper than the next closest competitor. Less force means easier, more comfortable scaling for the clinician and patient.

Proprietary Process

Our proprietary processing ensures that the superior edge retention and wear characteristics of EverEdge™ Technology will last the entire life of the instrument. Since EverEdge™ is not a superficial coating, the instruments can be resharpened like any other scaler.

Diamond Knurl

The unique diamond knurl pattern on the large diameter handle provides a confident and comfortable grasp. The #9 EverEdge™ handle was also designed to be the optimal weight for reduced hand fatigue while the Harmony™ Ergonomic Handle designed with TrueFit™ Technology is scientifically proven to be truly ergonomic.

Stays Sharper Even Longer

EverEdge™ 2.0 uses an optimized heat control process in order to maintain the hard, sharp edge. This heat control, plus several manufacturing intricacies in our proprietary process, provide the durability needed for effective procedures and continued use.

Comfort Zone

In the transition zone between the handle and working end the lightly textured silicone grips provide for a secure and comfortable grasp.



For more information on EverEdge™ 2.0 Technology, visit HuFriedyGroup.com/EE2.



Handle Options

We offer a wide variety of handle options for our hand scaling instruments giving clinicians a choice between styles, materials, and textures. Take a look below at our EverEdge™ 2.0 Scaler and Curette Handles as well as our handle options for our Immunity Steel™ Scalers and Curettes.

 For more information on EverEdge™ 2.0 Handles options, visit HuFriedyGroup.com/Scalers.

EverEdge™ 2.0 Handles

Harmony™ Ergonomic Handle



#9 Handle



#G9, Steel Grip



#C8 ResinEight™ Colors Handle



Immunity Steel™ Handles

#6 Satin Steel™ Handle



#7 Satin Steel™ Colours Handle



#8 ResinEight™ Handle



#2 Octagonal Handle

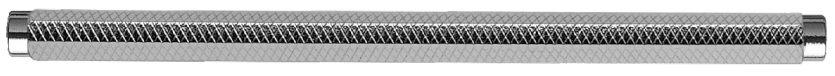

¹ Compared to the Hu-Friedy #9 metal handle, these are the nominal values. Data on file. Available on request.

HARMONY™

SCIENTIFICALLY PROVEN ERGONOMIC SCALERS AND CURETTES

Knowing nearly 70% of RDHs experience hand, wrist, and/or arm pain,¹ HuFriedyGroup proactively developed an innovative and truly ergonomic hand scaling solution. Building off the success of EverEdge™ 2.0, the Harmony™ Ergonomic Scalers and Curettes designed with TrueFit™ Technology are the latest addition to the best-in-class hand instrument portfolio.



Learn How to Scale in Perfect Harmony at
[HuFriedyGroup.com/Harmony](https://www.hufriedygroup.com/Harmony)

1. Compared to other leading scaler designs. Data on file. Available upon request.



Gracey Curettes

Gracey curettes are area-specific curettes with blades having a single cutting edge, offset at 70° to the shank, to provide a perfect working angulation to the tooth surface.



Learn more about our [Gracey Curettes](#).

Standard Gracey Curettes

Standard Gracey Curettes allow for deep scaling, root planing and periodontal debridement. Gracey Rigid curettes have thicker, stronger and less flexible shanks than Standard Graceys to allow for removal of moderate to heavy calculus. Gracey Extra Rigid Curettes are ideal for tenacious calculus removal. Standard, Rigid and Extra Rigid Gracey Curettes all have identical blade dimensions.

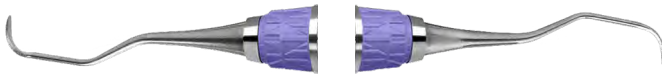

Gracey 1/2 Curette	Standard	Rigid
Harmony	SG1/2XE2	SG1/2RXE2
#9	SG1/29E2	SG1/2R9E2
#G9, Steel Grip	SG1/2G9E2	SG1/2RG9E2
#C8, Gray	SG1/2C8E2	SG1/2RC8E2
#6	SG1/26	SG1/2R6
#7	SG1/27	SG1/2R7
#8	SG1/28	SG1/2R8
#2	SG1/2	SGR1/2R



Gracey 3/4 Curette	Standard	Rigid
Harmony	SG3/4XE2	SG3/4RXE2
#9	SG3/49E2	SG3/4R9E2
#C8, Gray	SG3/4C8E2	SG3/4RC8E2
#6	SG3/46	SG3/4R6
#7	SG3/47	SG3/4R7
#8, Gray	SG3/48	SG3/4R8
#2	SG3/4	SGR3/4R



Gracey 5/6 Curette	Standard	Rigid	Extra Rigid
Harmony	SG5/6XE2	SG5/6RXE2	N/A
#9	SG5/69E2	SG5/6R9E2	N/A
#G9, Steel Grip	SG5/6G9E2	N/A	N/A
#C8, Yellow	SG5/6C8E2	SG5/6RC8E2	N/A
#6	SG5/66	SG5/6R6	SG5/6ER6
#7	SG5/67	SG5/6R7	SG5/6ER7
#8, Gray	SG5/68	SG5/6R8	SG5/6ER8
#2	SG5/6	SGR5/6R	N/A



Gracey 7/8 Curette	Standard	Rigid	Extra Rigid
Harmony	SG7/8XE2	SG7/8RXE2	N/A
#9	SG7/89E2	SG7/8R9E2	N/A
#G9, Steel Grip	SG7/8G9E2	SG7/8RG9E2	N/A
#C8, Green	SG7/8C8E2	SG7/8RC8E2	N/A
#6	SG7/86	SG7/8R6	SG7/8ER6
#7	SG7/87	SG7/8R7	SG7/8ER7
#8, Gray	SG7/88	SG7/8R8	SG7/8ER8
#2	SG7/8	SGR7/8R	N/A



Gracey 7/8



Gracey 9/10 Curette	Standard	Rigid
Harmony	SG9/10XE2	SG9/10RXE2
#9	SG9/109E2	SG9/10R9E2
#C8, Green	SG9/10C8E2	N/A
#6	SG9/106	SG9/10R6
#7	SG9/107	SG9/10R7
#8, Gray	SG9/108	SG9/10R8
#2	SG9/10	SGR9/10R



Gracey 11/12 Curette	Standard	Rigid	Extra Rigid
Harmony	SG11/12XE2	SG11/12RXE2	N/A
#9	SG11/129E2	SG11/12R9E2	N/A
#G9, Steel Grip	SG11/12G9E2	SG11/12RG9E2	N/A
#C8, Orange	SG11/12C8E2	SG11/12RC8E2	N/A
#6	SG11/126	SG11/12R6	SG11/12ER6
#7	SG11/127	SG11/12R7	SG11/12ER7
#8, Gray	SG11/128	SG11/12R8	SG11/12ER8
#2	SG11/12	SGR11/12R	N/A



Gracey 11/12



Gracey 13/14 Curette	Standard	Rigid	Extra Rigid
Harmony	SG13/14XE2	SG13/14RXE2	N/A
#9	SG13/149E2	SG13/14R9E2	N/A
#G9, Steel Grip	SG13/14G9E2	SG13/14RG9E2	N/A
#C8, Blue	SG13/14C8E2	SG13/14RC8E2	N/A
#6	SG13/146	SG13/14R6	SG13/14ER6
#7	SG13/147	SG13/14R7	SG13/14ER7
#8, Gray	SG13/148	SG13/14R8	SG13/14ER8
#2	SG13/14	SGR13/14R	N/A



Gracey 13/14



Gracey 15/16 Curette	Standard	Rigid	Extra Rigid
Harmony	SG15/16XE2	SG15/16RXE2	N/A
#9	SG15/169E2	SG15/16R9E2	N/A
#G9, Steel Grip	SG15/16G9E2	SG15/16RG9E2	N/A
#C8, Orange	SG15/16C8E2	SG15/16RC8E2	N/A
#6	SG15/166	SG15/16R6	SG15/16ER6
#7	SG15/167	SG15/16R7	N/A
#8, Gray	SG15/168	SG15/16R8	SG15/16ER8
#2	SG15/16	SGR15/16R	N/A



Gracey 15/16



Gracey 17/18 Curette	Standard	Rigid
Harmony	SG17/18XE2	SG17/18RXE2
#9	SG17/189E2	SG17/18R9E2
#G9, Steel Grip	SG17/18G9E2	N/A
#C8, Blue	SG17/18C8E2	SG17/18RC8E2
#6	SG17/186	SG17/18R6
#7	SG17/187	SG17/18R7
#8, Gray	SG17/188	SG17/18R8
#2	SG17/18	SGR17/18R

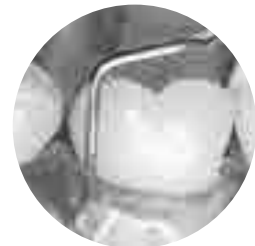

Gracey 17/18



Gracey 11/14 Curette	Standard	Rigid
Harmony	SG11/14XE2	N/A
#9	SG11/149E2	N/A
#C8, Red	SG11/14C8E2	N/A
#6	SG11/146	N/A
#7	SG11/147	N/A
#8, Gray	SG11/148	N/A
#2	SG11/14	SG11/14R



Gracey 12/13 Curette	Standard	Rigid
Harmony	SG12/13XE2	N/A
#9	SG12/139E2	N/A
#C8, Red	SG12/13C8E2	N/A
#6	SG12/136	N/A
#7	SG12/137	N/A
#8, Gray	SG12/138	N/A
#2	SG12/13	SG12/13R



Gracey After Five™ Currettes

Gracey After Five™ Currettes feature a terminal shank that is 3mm longer and a blade that is 10% thinner than the Standard Gracey Curette. The thinner blade allows for less tissue distention when accessing deep pockets.



Gracey 1/2 After Five™ Curette	Standard	Rigid
Harmony	SRPG1/2XE2	SRP1/2RXE2
#9	SRPG1/29E2	SRP1/2R9E2
#G9, Steel Grip	SRPG1/2G9E2	SRP1/2RG9E2
#C8, Gray	SRPG1/2C8E2	SRP1/2RC8E2
#6	SRPG1/26	SRP1/2R6
#7	SRPG1/27	SRP1/2R7
#8, Gray	SRPG1/28	SRP1/2R8
#2	SRPG1/2	SRPG1/2R



Gracey 3/4 After Five™ Curette	Standard	Rigid
Harmony	SRPG3/4XE2	SRP3/4RXE2
#9	SRPG3/49E2	SRP3/4R9E2
#C8, Gray	SRPG3/4C8E2	SRP3/4RC8E2
#6	SRPG3/46	SRP3/4R6
#7	SRPG3/47	SRP3/4R7
#8, Gray	SRPG3/48	SRP3/4R8
#2	SRPG3/4	SRPG3/4R



Gracey 5/6 After Five™ Curette	Standard	Rigid	Extra Rigid
Harmony	SRPG5/6XE2	SRP5/6RXE2	N/A
#9	SRPG5/69E2	SRP5/6R9E2	N/A
#C8, Yellow	SRPG5/6C8E2	SRP5/6RC8E2	N/A
#6	SRPG5/66	SRP5/6R6	SRP5/6E6
#7	SRPG5/67	SRP5/6R7	SRP5/6E7
#8, Gray	SRPG5/68	SRP5/6R8	SRP5/6E8
#2	SRPG5/6	SRPG5/6R	N/A



Gracey 7/8 After Five™ Curette	Standard	Rigid	Extra Rigid
Harmony	SRPG7/8XE2	SRP7/8RXE2	N/A
#9	SRPG7/89E2	SRP7/8R9E2	N/A
#C8, Green	SRPG7/8C8E2	SRP7/8RC8E2	N/A
#6	SRPG7/86	SRP7/8R6	SRP7/8E6
#7	SRPG7/87	SRP7/8R7	SRP7/8E7
#8, Gray	SRPG7/88	SRP7/8R8	SRP7/8E8
#2	SRPG7/8	SRPG7/8R	N/A

Best in Practice Fact
 The Rigid Gracey has a thicker, stronger, and less flexible shank than the standard Gracey. This allows for removal of moderate to heavy calculus. Blades are identical in size to standard Gracey currettes.



Gracey 11/12 After Five™ Curette	Standard	Rigid	Extra Rigid
Harmony	SRPG11/12XE2	SRP11/12RXE2	N/A
#9	SRPG11/129E2	SRP11/12R9E2	N/A
#G9, Steel Grip	SRPG11/12G9E2	SRP11/12RG9E2	N/A
#C8, Orange	SRPG11/12C8E2	SRP11/12RC8E2	N/A
#6	SRPG11/126	SRP11/12R6	SRP11/12E6
#7	SRPG11/127	SRP11/12R7	SRP11/12E7
#8, Gray	SRPG11/128	SRP11/12R8	SRP11/12E8
#2	SRPG11/12	SRPG11/12R	N/A



Gracey 13/14 After Five™ Curette	Standard	Rigid	Extra Rigid
Harmony	SRPG13/14XE2	SRP13/14RXE2	N/A
#9	SRPG13/149E2	SRP13/14R9E2	N/A
#G9, Steel Grip	SRPG13/14G9E2	SRP13/14RG9E2	N/A
#C8, Blue	SRPG13/14C8E2	SRP13/14RC8E2	N/A
#6	SRPG13/146	SRP13/14R6	SRP13/14E6
#7	SRPG13/147	SRP13/14R7	SRP13/14E7
#8, Gray	SRPG13/148	SRP13/14R8	SRP13/14E8
#2	SRPG13/14	SRPG13/14R	N/A



Gracey 15/16 After Five™ Curette	Standard	Rigid
Harmony	SRPG15/16XE2	SRP15/16RXE2
#9	SRPG15/169E2	SRP15/16R9E2
#G9, Steel Grip	SRPG15/16G9E2	N/A
#C8, Orange	SRPG15/16C8E2	SRP15/16RC8E2
#6	SRPG15/166	SRP15/16R6
#7	SRPG15/167	SRP15/16R7
#8, Gray	SRPG15/168	SRP15/16R8
#2	SRPG15/16	SRPG15/16R



Gracey 11/14 After Five™ Curette	
Harmony	SRPG11/14XE2
#9	SRPG11/149E2
#C8, Red	SRPG11/14C8E2
#6	SRPG11/146
#7	SRPG11/147
#2	SRPG11/14



Gracey 12/13 After Five™ Curette	
Harmony	SRPG12/13XE2
#9	SRPG12/139E2
#C8, Red	SRPG12/13C8E2
#6	SRPG12/136
#7	SRPG12/137
#8, Gray	SRPG12/138
#2	SRPG12/13



Gracey Mini Five™ Currettes

Gracey Mini Five™ Currettes feature a terminal shank that is 3mm longer and a blade that is 50% shorter and 10% thinner than a Standard Gracey Curette. Gracey Mini Five™ Currettes are ideal for deep, narrow pockets.



Gracey 1/2 Mini Five™ Curette	Standard	Rigid
Harmony	SAS1/2XE2	SAS1/2RXE2
#9	SAS1/29E2	SAS1/2R9E2
#G9, Steel Grip	SAS1/2G9E2	N/A
#C8, Gray	SAS1/2C8E2	SAS1/2RC8E2
#6	SAS1/26	SAS1/2R6
#7	SAS1/27	SAS1/2R7
#8, Gray	SAS1/28	SAS1/2R8
#2	SAS1/2	SAS1/2R



Gracey 3/4 Mini Five™ Curette	Standard	Rigid
Harmony	SAS3/4XE2	SAS3/4RXE2
#9	SAS3/49E2	SAS3/4R9E2
#C8, Gray	SAS3/4C8E2	SAS3/4RC8E2
#6	SAS3/46	SAS3/4R6
#7	SAS3/47	SAS3/4R7
#8, Gray	SAS3/48	SAS3/4R8
#2	SAS3/4	SAS3/4R



Gracey 5/6 Mini Five™ Curette	Standard	Rigid
Harmony	SAS5/6XE2	SAS5/6RXE2
#9	SAS5/69E2	SAS5/6R9E2
#C8, Yellow	SAS5/6C8E2	SAS5/6RC8E2
#6	SAS5/66	SAS5/6R6
#7	SAS5/67	SAS5/6R7
#8, Gray	SAS5/68	SAS5/6R8
#2	SAS5/6	SAS5/6R



Mini Five® Gracey Currettes

- Terminal shank is 3 mm longer than Standard Gracey.
- Compared to the standard Gracey curette, blade is 50% shorter and 10% thinner.
- Allows for greater access in deep periodontal pockets.



Mini Five reaching into a deep pocket on a narrow root.

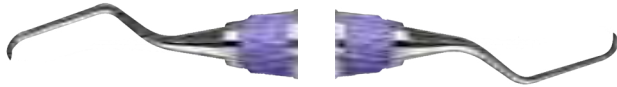

Gracey 7/8 Mini Five™ Curette	Standard	Rigid
Harmony	SAS7/8XE2	SAS7/8RXE2
#9	SAS7/89E2	SAS7/8R9E2
#C8, Green	SAS7/8C8E2	SAS7/8RC8E2
#6	SAS7/86	SAS7/8R6
#7	SAS7/87	SAS7/8R7
#8, Gray	SAS7/88	SAS7/8R8
#2	SAS7/8	SAS7/8R



Gracey 13/14 Mini Five™ Curette	Standard	Rigid
Harmony	SAS13/14XE2	SAS13/14RXE2
#9	SAS13/149E2	SAS13/14R9E2
#G9, Steel Grip	SAS13/14G9E2	N/A
#C8, Blue	SAS13/14C8E2	SAS13/14RC8E2
#6	SAS13/146	SAS13/14R6
#7	SAS13/147	SAS13/14R7
#8, Gray	SAS13/148	SAS13/14R8
#2	SAS13/14	SAS13/14R

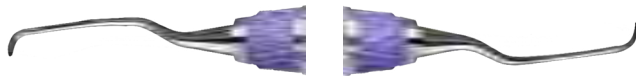

Gracey 11/12 Mini Five™ Curette	Standard	Rigid
Harmony	SAS11/12XE2	SAS11/12RXE2
#9	SAS11/129E2	SAS11/12R9E2
#G9, Steel Grip	SAS11/12G9E2	N/A
#C8, Orange	SAS11/12C8E2	SAS11/12RC8E2
#6	SAS11/126	SAS11/12R6
#7	SAS11/127	SAS11/12R7
#8, Gray	SAS11/128	SAS11/12R8
#2	SAS11/12	SAS11/12R



Gracey 15/16 Mini Five™ Curette	Standard	Rigid
Harmony	SAS15/16XE2	SAS15/16RXE2
#9	SAS15/169E2	SAS15/16R9E2
#G9, Steel Grip	SAS15/16G9E2	N/A
#C8, Orange	SAS15/16C8E2	SAS15/16RC8E2
#6	SAS15/166	SAS15/16R6
#7	SAS15/167	SAS15/16R7
#8, Gray	SAS15/168	SAS15/16R8
#2	SAS15/16	SAS15/16R



Gracey 11/14 Mini Five™ Curette	
Harmony	SAS11/14XE2
#9	SAS11/149E2
#C8, Red	SAS11/14C8E2
#6	SAS11/146
#7	SAS11/147
#8, Gray	SAS11/148
#2	SAS11/14

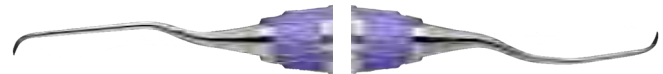

Gracey 12/13 Mini Five™ Curette	
Harmony	SAS12/13XE2
#9	SAS12/139E2
#C8, Red	SAS12/13C8E2
#6	SAS12/136
#7	SAS12/137
#8, Gray	SAS12/138
#2	SAS12/13



Gracey Micro Mini Five™ Currettes

Gracey Micro Mini Five™ Currettes feature an elongated shank to access deep, narrow periodontal pockets and a blade that is 50% shorter and 28% thinner than the Standard Gracey Curette.



Gracey 1/2 Micro Mini Five™ Curette	
Harmony	SMS1/2XE2
#9	SMS1/29E2



Gracey 7/8 Micro Mini Five™ Curette	
Harmony	SMS7/8XE2
#9	SMS7/89E2



Gracey 11/12 Micro Mini Five™ Curette	
Harmony	SMS11/12XE2
#9	SMS11/129E2



Gracey 13/14 Micro Mini Five™ Curette	
Harmony	SMS13/14XE2
#9	SMS13/149E2

The Clayton Gracey Story

In the late 1940s, an innovative dentist from the University of Michigan had a vision. Clayton Gracey wanted to “give every dentist the possibility to treat even the deepest and least accessible periodontal pockets simply and without traumatic stretching of the gingiva.”

Dr. Gracey brought his idea to Hugo Friedman, the founder of Hu-Friedy, who supported his concept. Together they developed a series of 14 single-ended area-specific instruments for the successful removal of deposits from root surfaces.

Dr. Gracey’s designs laid the groundwork for the new instruments of today. Currently, Gracey currettes are available as double-ended instruments with multiple handle choices.

The Gracey currettes have come a long way since the original design. Hu-Friedy currently manufactures a variety of styles and patterns, such as After Five® currettes with a longer terminal shank and thinned blade, Mini Five® currettes with After Five® features and a shorter blade, and the 15/16 and 17/18 patterns. An optional Rigid shank is available on all of the Gracey designs.



Hu-Friedy is continually looking for new ways to improve our existing products. Our success is dedicated to the pioneers in dentistry, including Dr. Clayton Gracey, who helped to make a vision become not only a reality, but also a part of every dental office today.



Pattison Gracey Lite Currettes

The Anna Pattison Currettes are modified from the original Gracey Currettes. These new instruments have shorter, thinner, smaller blades honed at a 60° angle with a modified rigid shank specially designed to allow easier access and insertion under tight tissue.



Learn more about our key opinion leader [Anna Pattison](#).



Pattison Gracey Lite 1/2 Curette

#9, Gray [SG1/29APE2](#)



Pattison Gracey Lite 7/8 Curette

#9, Green [SG7/89APE2](#)



Pattison Gracey Lite 11/12 Curette

#9, Orange [SG11/129APE2](#)



Pattison Gracey Lite 13/14 Curette

#9, Blue [SG13/149APE2](#)



Pattison Gracey Lite 11/14 Curette

#9, Purple [SG11/149APE2](#)



Pattison Gracey Lite 12/13 Curette

#9, Purple [SG12/139APE2](#)



Vision Curvettes

Vision Curvettes are modified Gracey Curettes that feature 5mm and 10mm shank markings to help visually assess pocket depth; and a blade identification mark (+) on the handle for easy determination of the cutting edge. The short, curved blades are ideal for root surfaces and furcations.

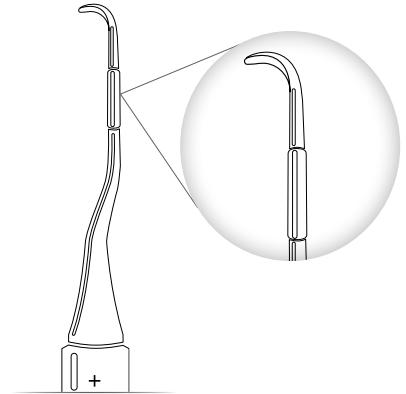

Sub-0 Vision Curvette

#6

SGCSUB-06



1/2 Vision Curvette

#6

SGC1/26



11/12 Vision Curvette

#6

SGC11/126



13/14 Vision Curvette

#6

SGC13/146

BioGent Currettes

Designed by Drs. Antonella Labriola and Pierpaolo Cortellini BioGent Currettes feature reduced blade width for non-traumatic and efficient access to the periodontium, modified angulation for better angulation and color coding for efficient time management.



Labriola-Cortellini Gracey 1/2 BioGent Curette
#9 **SG1/29LCE2**



Labriola-Cortellini Gracey 7/8 BioGent Curette
#9 **SG7/89LCE2**



Labriola-Cortellini Gracey 11/12 BioGent Curette
#9 **SG11/129LCE2**



Labriola-Cortellini Gracey 13/14 BioGent Curette
#9 **SG13/149LCE2**



Gracey Currettes Reference

Gracey Comparison Chart



Gracey Curette Blade Angulation

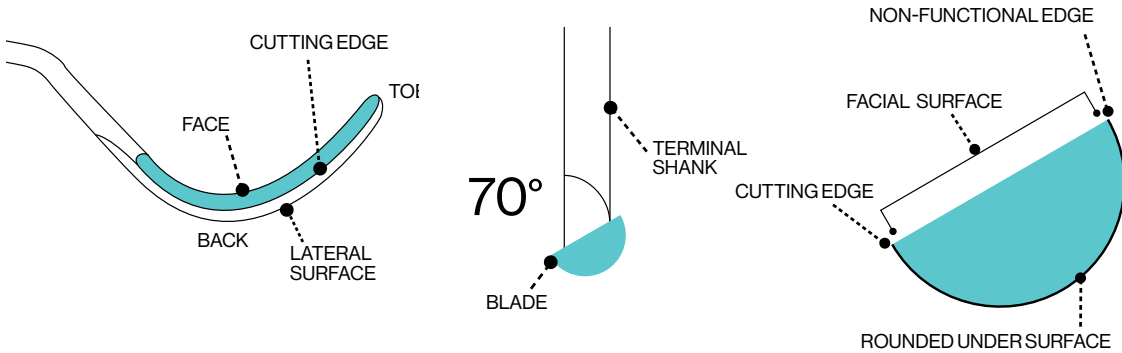

After Five® Gracey Currettes

Designed to adapt to a specific area or tooth surface.

- Longer terminal shank allows better access to deep pockets and areas with recession.
- Blade is 10% thinner than standard Gracey curette to allow for less tissue distention when accessing deeper pockets.

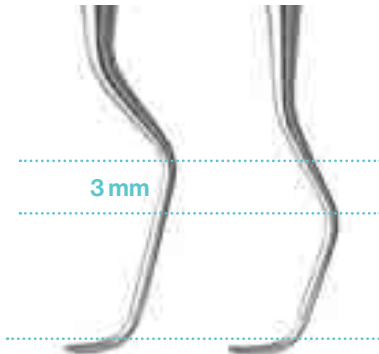

Terminal shank redesigned to be 3 mm longer than a standard Gracey curette.



Gracey After Five curette reaching deep into a pocket.

Design Comparisons

Refer to the chart to match instruments with area of application by using the color-coded diagram below.

Gracey Type	Shank Design & Diameter	Blade Length	Blade Width	Available Patterns & Area of Use
Standard (Finishing)	Standard	Standard	Standard	1/2, 3/4, 5/6 7/8, 9/10 11/12, 15/16 13/14, 17/18*
Rigid	Standard design, increased shank diameter	Standard	Standard	1/2, 3/4, 5/6 7/8, 9/10 11/12, 15/16 13/14, 17/18*
After Five*	Longer terminal shank, standard diameter	Standard	Decreased by 10% compared to Standard	1/2, 3/4, 5/6 7/8 11/12, 15/16 13/14
Rigid After Five	Longer terminal shank, increased diameter	Standard	Decreased by 10% compared to Standard	1/2, 3/4, 5/6 7/8 11/12, 15/16 13/14
Mini Five	Longer terminal shank, standard diameter	Decreased by 50%	Decreased by 10% compared to Standard	1/2, 3/4, 5/6 7/8 11/12, 15/16 13/14
Rigid Mini Five	Longer terminal shank, increased diameter	Decreased by 50%	Decreased by 10% compared to Standard	1/2, 3/4, 5/6 7/8 11/12, 15/16 13/14
Micro Mini Five	Longer terminal shank, increased diameter	Decreased by 50%	Decreased by 20% compared to Mini Five	1/2 7/8 11/12 13/14

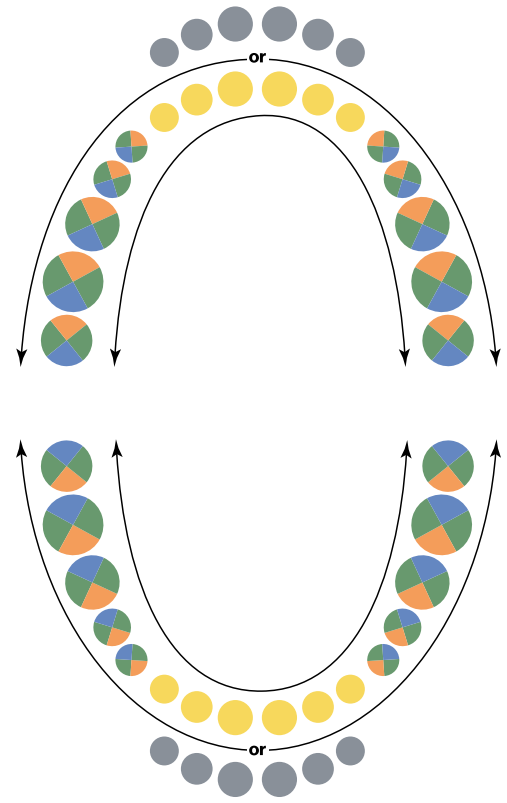

	Anterior	1/2, 3/4, 5/6
	Buccal/Lingual	7/8, 9/10
	Mesial Surfaces Premolars, Molars	11/12, 15/16
	Distal Surfaces Premolars, Molars	13/14, 17/18*

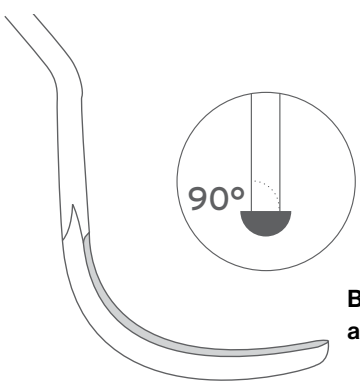

Blade angulation of a Universal Curette

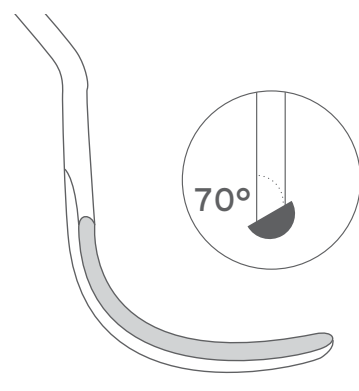

Blade angulation of a Gracey Curette



Universal Currettes

Universal Currettes have two parallel cutting edges that meet at a rounded toe. The back surface is rounded giving a semi-circular cross section. Due to this rounded back surface, currettes are ideal for the removal of subgingival debris.



Learn more about our [Universal Currettes](#).

Langer Currettes

The Langer Curette design combines the benefits of a universal curette blade with two cutting edges and the shank designs of area specific currettes. The Langer Currettes were originally designed to be used in a set of three (1/2, 3/4, 5/6), to adapt to most tooth surfaces, and to be suitable for scaling as well as periodontal surgery.



Langer 1/2 Curette	Standard	Rigid
Harmony	SL1/2XE2	N/A
#9	SL1/29E2	N/A
#C8, Lavender	SL1/2C8E2	N/A
#6	SL1/26	SL1/2R6
#7	SL1/27	SL1/2R7
#8, Gray	SL1/28	N/A
#2	SL1/22	N/A

Langer 1/2 After Five™ Curette

A 3 mm longer terminal shank and a thinner blade for improved access

#9	SL1/2AF9E2
#6	SL1/2AF6

Langer 1/2 Mini Five™ Curette

Longer terminal shank, standard diameter, and blade half the length of the After Five™ Currettes

#9	SL1/2MF9E2
#6	SL1/2MF6

Best in Practice Fact

- The Langer curette takes a “best of both worlds” approach to instrument design. The curette pairs a universal blade — featuring two parallel edges and a 90-degree angle between the terminal shank and blade face — with the shank design of area-specific Gracey currettes. The result is an instrument that adapts well and is efficient.



Langer 3/4 Curette	Standard	Rigid
Harmony	SL3/4XE2	N/A
#9	SL3/49E2	N/A
#C8, Lavender	SL3/4C8E2	N/A
#6	SL3/46	SL3/4R6
#7	SL3/47	SL3/4R7
#8, Gray	SL3/48	N/A
#2	SL3/42	N/A

Langer 3/4 Mini Five™ Curette	
Longer terminal shank, standard diameter, and blade half the length of the After Five™ Curettes	
#9	SL3/4MF9E2
#6	SL3/4MF6

Langer 3/4 After Five™ Curette	
#9	SL3/4AF9E2



Langer 5/6 Curette	Standard	Rigid
Harmony	SL5/6XE2	N/A
#9	SL5/69E2	N/A
#C8, Lavender	SL5/6C8E2	N/A
#6	SL5/66	SL5/6R6
#7	SL5/67	N/A
#8, Gray	SL5/68	N/A

Langer 5/6 Mini Five™ Curette	
Longer terminal shank, standard diameter, and blade half the length of the After Five™ Curettes	
#9	SL5/6MF9E2
#6	SL5/6MF6

Langer 5/6 After Five™ Curette	
#6	SL5/6AF6



Langer 17/18 Curette	Standard	Rigid
Harmony	SL17/18XE2	N/A
#9	SL17/189E2	N/A
#C8, Lavender	SL17/18C8E2	N/A
#6	SL17/186	SL17/18R6
#7	SL17/187	N/A
#8, Gray	SL17/188	N/A

Langer Application Chart

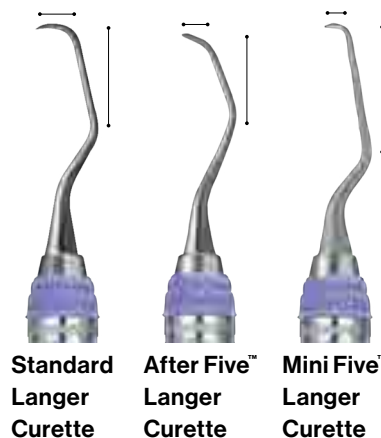
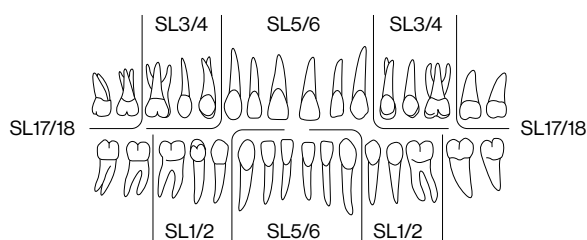

- Langer After Five and Mini Five Curette terminal shanks are elongated by 3 mm for access into deep periodontal pockets and root surfaces of 5 mm or more.
- Blade is 10% thinner than standard Langer to ease gingival insertion and reduce tissue distention.
- Langer Mini Five Curette has a reduced blade, half the length of the After Five Langer Curette or standard Langer, for better adaptation in narrow pockets and furcations.



Columbia Crettes

Columbia Crettes feature two parallel cutting edges that meet at a rounded toe. Anterior, posterior and universal designs are available.



Columbia 2R/2L Curette

Harmony	SC2R/2LXE2
#9	SC2R/2L9E2
#C8, Lavender	SC2R/2LC8E2
#6	SC2R/2L6
#7	SC2R/2L7
#8, Gray	SC2R/2L8
#2	SC2R/2L



Columbia 4R/4L Curette

Harmony	SC4R/4LXE2
#9	SC4R/4L9E2
#G9, Steel Grip	SC4R/4LG9E2
#C8, Lavender	SC4R/4LC8E2
#6	SC4R/4L6
#7	SC4R/4L7
#8, Gray	SC4R/4L8
#2	SC4R/4L



Columbia 13/14 Curette

	Standard	Rigid
Harmony	SC13/14XE2	N/A
#9	SC13/149E2	N/A
#G9, Steel Grip	SC13/14G9E2	
#C8, Lavender	SC13/14C8E2	N/A
#6	SC13/146	SC13/14R6
#7	SC13/147	SC13/14R7
#8, Gray	SC13/148	SC13/14R8
#2	SC13/14	SC13/14R



Columbia 13/14 Curved Tip Curette

#2	SC13/14C
----	-----------------

Barnhart Currettes

Barnhart Universal Currettes are designed with two cutting edges and a rounded toe for use on all posterior surfaces. Barnhart Currettes have a less pronounced blade curvature than other universal currettes combined with a long shank. Available in standard, rigid and USC versions.



Barnhart 1/2 Curette	Standard	Rigid
Harmony	SBH1/2XE2	SBH1/2RXE2
#9	SBH1/29E2	SBH1/2R9E2
#G9, Steel Grip	SBH1/2G9E2	SBH1/2RG9E2
#C8, Lavender	SBH1/2C8E2	SBH1/2RC8E2
#6	SBH1/26	SBH1/2R6
#7	SBH1/27	SBH1/2R7
#8, Gray	SBH1/28	SBH1/2R8
#2	SBH1/2	SBH1/2R



Barnhart 5/6 Curette	Standard	Rigid
Harmony	SBH5/6XE2	SBH5/6RXE2
#9	SBH5/69E2	SBH5/6R9E2
#G9, Steel Grip	SBH5/6G9E2	SBH5/6RG9E2
#C8, Lavender	SBH5/6C8E2	SBH5/6RC8E2
#6	SBH5/66	SBH5/6R6
#7	SBH5/67	SBH5/6R7
#8, Gray	SBH5/68	SBH5/6R8
#2	SBH5/6	SBH5/6R



Barnhart USC 1/2 Curette	
Harmony	SBH1/2USCXE2
#9	SBH1/2USC9E2



Barnhart USC 5/6 Curette	
Harmony	SBH5/6USCXE2
#9	SBH5/6USC9E2



Furcation Currettes

Furcation Currettes are designed for scaling root concavities and furcations. The DeMarco Currettes are excellent for stain removal on anterior lingual surfaces.



#1 DeMarco Furcation Curette
#6 **SDM16**



#2 DeMarco Furcation Curette
#6 **SDM26**



Quetin Buccal-Lingual Furcation Curette
.09 mm
#6 **SQBL16**



Quetin Buccal-Lingual Furcation Curette
1.3 mm
#6 **SQBL26**

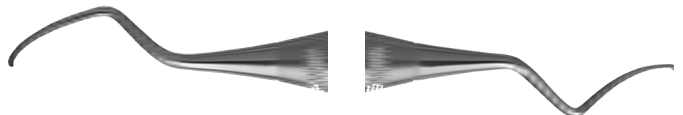

Quetin Mesial-Distal Furcation Curette
.09 mm
#6 **SQMD16**

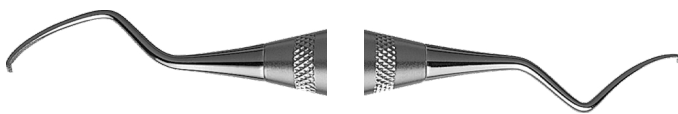

Quetin Mesial-Distal Furcation Curette
1.3 mm
#6 **SQMD26**

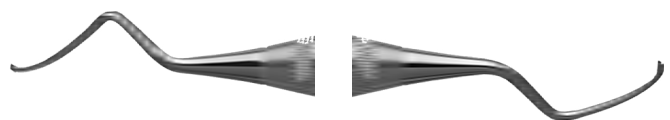

Quetin Labial-Lingual Scaler
#6 **SQLL36**



Standard Universal Curettes



Younger-Good 7/8 Curette

Harmony	SYG7/8XE2
#9	SYG7/89E2
#G9, Steel Grip	SYG7/8G9E2
#C8, Lavender	SYG7/8C8E2
#6	SYG7/86
#7	SYG7/87
#8, Gray	SYG7/88
#2	SYG7/8



Indiana University 13/14 Curette

#6	SIU13/146
#2	SIU13/14



Indiana University 17/18 Curette

#6	SIU17/186
#7	SIU17/187
#8, Gray	SIU17/188
#2	SIU17/18



Loma Linda 10/11 Curette	Standard	Rigid	Slim
#6	SLL10/116	SLL10/11R6	N/A
#7	SLL10/117	N/A	N/A
#8, Gray	SLL10/118	N/A	SLL10/11S8
#2	SLL10/112	N/A	N/A

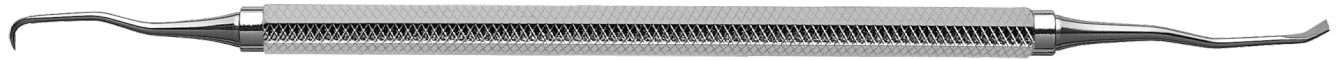

Bunting 1/2 Curette

#6	SBN1/26
#2	SBN1/2



Bunting 5/6 Curette

#2	SBN5/6
----	---------------



Ratcliff 3/4 Curette

Harmony	SUCR3/4XE2
#9	SUCR3/49E2
#6	SUCR3/46
#8, Gray	SUCR3/48

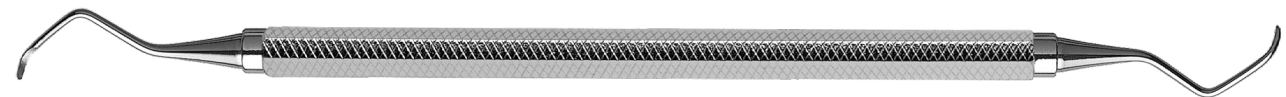

#411/412 Curette

#2	S411/412
----	-----------------



#413/414 Curette

#2	S413/414
----	-----------------



ME-1 (10-11) Curette

#2	SME1
----	-------------



Mallery 1/2 Curette

#2

SMAL1/2



Rule 3/4 Curette

#2

SR3/4

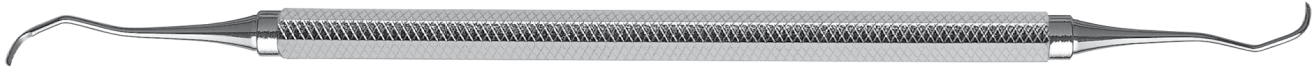

Goldman 31/31 Curette

#2

SHG31/32



Sickle Scalers

Sickle Scalers have two cutting edges that meet at a pointed tip. The back surface is pointed giving a triangular cross-section. The blade can be straight or curved. Sickle Scalers are designed primarily for the removal of supragingival debris.

Nevi™ Scalers

Nevi™ Scalers feature unique angles and distinct characteristics to allow for improved access and reach into interproximal areas.



Nevi™ 1 Anterior Sickle Scaler	
Harmony	SCNEV11XE2
#9	SCNEV119E2
#G9, Steel Grip	SCNEV11G9E2
#C8, Lavender	SCNEV11C8E2
#6	SCNEV11
#8, Gray	SCNEV118
#7	SCNEV117



Nevi™ 1/H5 Anterior Sickle/Discoïd Scaler	
Harmony	SNEV1/H5XE2
#9	SNEV1/H59E2
#G9, Steel Grip	SNEV1/H5G9E2
#C8, Lavender	SNEV1/H5C8E2
#6	SNEV1/H56
#8, Gray	SNEV1/H58
#7	SNEV1/H57



Nevi™ 2 Posterior Sickle Scaler	
Harmony	SCNEVI2XE2
#9	SCNEVI29E2
#G9, Steel Grip	SCNEVI2G9E2
#C8, Red	SCNEVI2C8E2
#6	SCNEVI2
#7	SCNEVI27
#8, Gray	SCNEVI28



Nevi™ 3 Posterior Sickle Scaler	
Harmony	SCNEVI3XE2
#9	SCNEVI39E2
#G9, Steel Grip	SCNEVI3G9E2
#C8, Red	SCNEVI3C8E2



Nevi™ 4 Posterior Sickle Scaler	
Harmony	SCNEVI4XE2
#9	SCNEVI49E2
#G9, Steel Grip	SCNEVI4G9E2
#C8, Red	SCNEVI4C8E2
#6	SCNEVI46



Nevi™ 4 Lite Posterior Sickle Scaler	
Harmony	SCNEVI4LXE2
#9	SCNEVI4L9E2
#G9, Steel Grip	SCNEVI4LG9E2
#C8, Red	SCNEVI4LC8E2



Anterior Sickle Scalers

Anterior Sickle Scalers have a straight or slightly angled shank. The blades can be curved, straight, or combined.

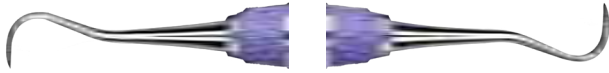

H6/7 Sickle Scaler	
Harmony	SH6/7XE2
#9	SH6/79E2
#G9, Steel Grip	SH6/7G9E2
#C8, Lavender	SH6/7C8E2
#6	SH6/76
#7	SH6/77
#8, Gray	SH6/78
#2	SH6/7



H5/33 Sickle Scaler	
Harmony	SH5/33XE2
#9	SH5/339E2
#G9, Steel Grip	SH5/33G9E2
#C8, Lavender	SH5/33C8E2
#6	SH5/336
#7	SH5/337
#8, Gray	SH5/338
#2	SH5/33

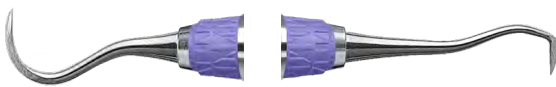

U15/30 Towner-Jacquette Sickle Scaler	
Harmony	SU15/30XE2
#9	SU15/309E2
#G9, Steel Grip	SU15/30G9E2
#C8, Purple	SU15/30C8E2
#6	SU15/306
#7	SU15/307
#8, Gray	SU15/308
#2	SU15/30



U15/33 Towner-Jacquette Sickle Scaler	
Harmony	SU15/33XE2
#9	SU15/339E2
#G9, Steel Grip	SU15/33G9E2
#C8, Purple	SU15/33C8E2
#6	SU15/336
#7	SU15/337
#8, Gray	SU15/338
#2	SU15/33



H5/U15 Hygienist-Towner Sickle Scaler	
#6	SH5/U156
#2	SH5/U15



U15 Towner Sickle, Single-End	
#6	SU156
#7	SU157
#8, Gray	SU158
#24	SU151



Goldman 6/7 Sickle Scaler

#6	SHG6/76
#7	SHG6/77
#8, Gray	SHG6/78
#2	SHG6/7



Nebraska 128 Scaler, Double-End

Harmony	SN128DEXE2
#9	SN128DE9E2
#G9, Steel Grip	SN128DEG9E2
#C8, Lavender	SN128DEC8E2



Nebraska 128 Scaler, Nevi1 Discoid

#9	SN128/NEV19E2
----	-------------------------------



Nebraska 128 Scaler, Single-End

#6	SN1286
#7	SN1287
#8, Gray	SN1288
#24	SN128



137 Sickle Scaler

Harmony	SN137XE2
#9	SN1379E2
#C8, Lavender	SN137C8E2
#6	SN1376
#7	SN1377
#8, Gray	SN1378

137 Mini Five™

#6	SN137M6
#7	SN137M7
#8	SN137M8



Morse 0/00 Scaler

Harmony	SM0/00XE2
#9	SM0/009E2
#G9, Steel Grip	SM0/00G9E2
#C8, Lavender	SM0/00C8E2
#6	SM0/006
#7	SM0/007
#8, Gray	SM0/008
#2	SM0/00



USC 128 Scaler

#6	SUSC1286
#24	SUSC128



#1 Springfield Scaler, Single-End

#6	SSP16
#24	SSP1



Younger-Good 15 Scaler, Single-End

#6	SYG156
#1	SYG15



#WH-2 Whiteside Scaler, Single-End

#24	SWH2
-----	----------------------

Posterior Sickle Scalers

Posterior Sickle Scalers are designed with contra-angled shanks for areas difficult to access, such as posterior interproximal surfaces. The blades can be curved or straight.



Learn more about our [Sickle Scalers](#).



204 Posterior Sickle Scaler

#6	S2046
#2	S204

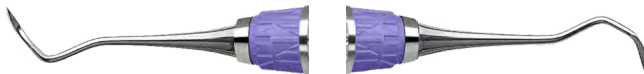

204S Posterior Sickle Scaler

Harmony	S204SXE2
#9	S204S9E2
#G9, Steel Grip	S204SG9E2
#C8, Red	S204SC8E2
#6	S204S6
#7	S204S7
#8, Gray	S204S8
#2	S204S



204SD Posterior Sickle Scaler

Harmony	S204SDXE2
#9	S204SD9E2
#G9, Steel Grip	S204SDG9E2
#C8, Red	S204SDC8E2
#6	S204SD6
#7	S204SD7
#8, Gray	S204SD8
#2	S204SD2



204IFUW Sickle Scaler	
Harmony	SIUFW204XE2
#9	SIUFW2049E2
#C8, Red	SIUFW204C8E2
#6	SIUFW2046
#7	SIUFW2047
#8, Gray	SIUFW2048
#2	SIUFW204

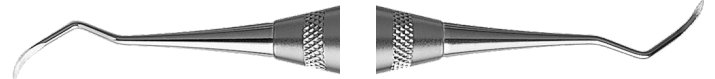

Springfield 2/3 Scaler	
#6	SSP2/36
#2	SSP2/3



#135 Scaler	
Harmony	SN135XE2
#9	SN1359E2
#G9, Steel Grip	SN135G9E2
#C8, Red	SN135C8E2
#6	SN1356
#7	SN1357
#8, Gray	SN1358



Taylor T2/T3 Scaler	
#6	ST2/36
#7	ST2/37
#8, Gray	ST2/38
#2	ST2/3

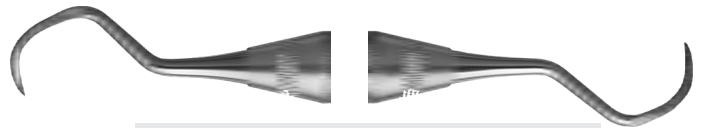

Remington 3/4 Scaler	
#6	SRM3/46
#2	SRM3/4

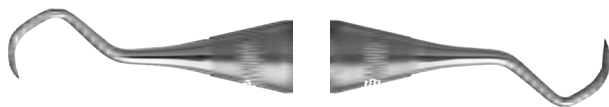

#129 Scaler	
#6	S1296
#2	S129



SM23 Scaler	
Harmony	SM23XE2
#9	SM239E2
#C8, Red	SM23C8E2
#6	SM236
#7	SM237
#2	SM23



Jacquette Sickle Scalers

Jacquette Sickle Scalers have two cutting edges on a straight blade that end at a sharp point. The back surface of the blade is pointed giving a triangular cross-section.

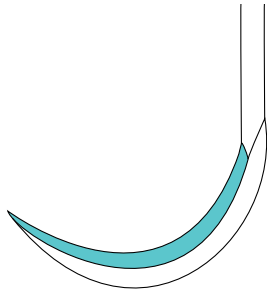

The Curved Sickle Scaler
Two cutting edges on a curved blade that end in a sharp point

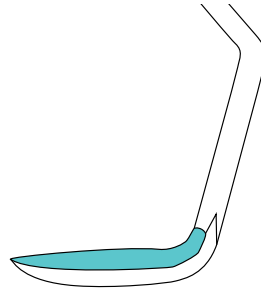

The Straight Sickle Scaler
Two cutting edges on a straight blade that end in a sharp point (also known as a Jacquette Scaler)



30/33 Standard/Mini Jacquette Scaler	
Harmony	SJ30/33XE2
#9	SJ30/339E2
#C8, Lavender	SJ30/33C8E2
#6	SJ30/336
#7	SJ30/337
#8, Gray	SJ30/338
#2	SJ30/33



31/32 Standard Jacquette Scaler	
Harmony	SJ31/32XE2
#9	SJ31/329E2
#C8, Red	SJ31/32C8E2
#6	SJ31/326
#7	SJ31/327
#8, Gray	SJ31/328
#2	SJ31/32



34/35 Mini Jacquette Scaler	
Harmony	SJ34/35XE2
#9	SJ34/359E2
#C8, Red	SJ34/35C8E2
#6	SJ34/356
#7	SJ34/357
#8, Gray	SJ34/358
#2	SJ34/35



H3/H4 Jacquette Scaler	
#6	SH3/46
#2	SH3/4



14/15 Posterior Jacquette Scaler	
#6	SJ14/156
#2	SJ14/15



Specialty Scalers



CI #1 Scaler	
#6	SCI16
#24	SCI1



CI 2/3 DE Scaler	
#6	SCI2/36
#7	SCI2/37
#2	SCI2/3



Crane-Kaplan #6 Scaler	
#6	SCK66
#2	SCK6



Ball #1 Scaler, Single-End	
#24	SB1



Ball #4 Scaler, Single-End	
#24	SB4



Ball #2/3 Scaler	
#6	SB2/36
#2	SB2/3



Ball #5/6 Scaler	
#2	SB5/6



ResinEight™ Colors with EverEdge 2.0 Technology

Our ResinEight™ Colors Scalars and Curettes are ergonomic, lightweight and offer a color-coding system based on specific areas of the mouth. Plus, each instrument features our proprietary EverEdge™ 2.0 Technology, which keeps the working ends sharper longer.

Points of Performance

- EverEdge™ 2.0 Technology provides consistently sharp, long-lasting cutting edges for efficient scaling
- Increased Rotational Control: The unique textured handle design has wave grooves and a special knurling texture for secure rotational control, providing a light secure grasp
- Easy Instrument Identification: Eight distinct colors allow clinicians to quickly and easily select instrument types that follow a color-coding system based on the specific area of the mouth where it is used



Color-Coding System

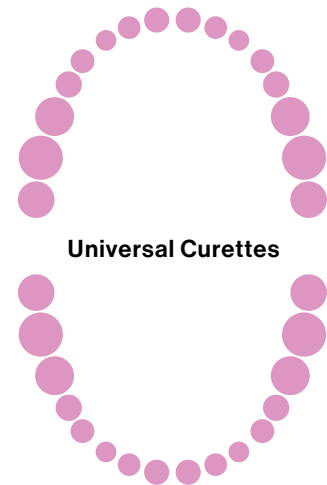
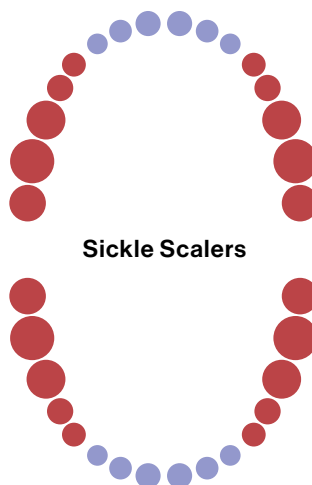
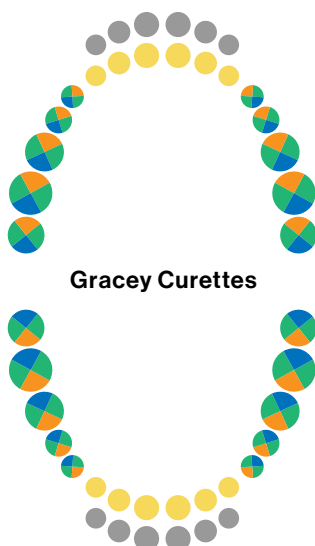



ResinEight™ Colors Guide

Gracey Currettes

Gracey 1/2	
● Standard	SG1/2C8E2
● Rigid	SG1/2RC8
● After Five	SRPG1/2C8E2
● After Five Rigid	SRP1/2RC8E2
● Mini Five	SAS1/2C8E2
● Mini Five Rigid	SS1/2RC8E2
Gracey 3/4	
● Standard	SG3/4C8E2
● Rigid	SG3/4RC8E2
● After Five	SRPG3/4C8E2
● After Five Rigid	SRP3/4RC8E2
● Mini Five	SAS3/4C8E2
● Mini Five Rigid	SS3/4RC8E2
Gracey 5/6	
● Standard	SG5/6C8E2
● Rigid	SG5/6RC8E2
● After Five	SRPG5/6C8E2
● After Five Rigid	SRP5/6RC8E2
● Mini Five	SAS5/6C8E2
● Mini Five Rigid	SS5/6RC8E2

Sickle Scalars

Anterior Sickle Scalars	
● Nevi 1	SCNEVI1C8E2
● Nevi 1/H5	SNEV1/H5C8E2
● H5/33	SH5/33C8E2
● H6/7	SH6/7C8E2
● 30/33 Jacquette	SJ30/33C8E2
● 0/00 Morse	SM0/00C8E2
● 137	SN137C8E2
● U15/30 Jacquette	SU15/30C8E2
● U15/33 Jacquette	SU15/33C8E2
● Centennial	SDH100C8E2
Posterior Sickle Scalars	
● 204 IUFW	SIUFW204C8E2
● 204S	S204SC8E2
● 204SD	S204SDC8E2
● Nevi 2	SCNEVI2C8E2
● Nevi 3	SCNEVI3C8E2
● Nevi 4	SCNEVI4C8E2
● 31/32 Jacquette	SJ31/32C8E2
● 34/35 Jacquette	SJ34/35C8E2
● 135	SN135C8E2

Gracey 7/8	
● Standard	SG7/8C8E2
● Rigid	SG7/8RC8E2
● After Five	SRPG7/8C8E2
● After Five Rigid	SRP7/8RC8E2
● Mini Five	SAS7/8C8E2
● Mini Five Rigid	SS7/8RC8E2
Gracey 9/10	
● Standard	SG9/10C8E2
Gracey 11/12	
● Standard	SG11/12C8E2
● Rigid	SG11/12RC8E2
● After Five	SRP11/12C8E2
● After Five Rigid	SP11/12RC8E2
● Mini Five	SAS11/12C8E2
● Mini Five Rigid	SS11/12RC8E2

Universal Currettes

Barnhart	
● 1/2	SBH1/2C8E2
● 1/2 Rigid	SBH1/2RC8E2
● 5/6	SBH5/6C8E2
● 5/6 Rigid	SBH5/6RC8E2
Columbia	
● 2R/2L	SC2R/2LC8E2
● 4R/4L	SC4R/4LC8E2
● 13/14	SC13/14C8E2
Younger-Good	
● 7/8	SYG7/8C8E2
McCall	
● 13/14	SM13/14C8E2
● 13S/14S	SM13/14SC8E2
● 17/18	SM17/18C8E2
Langer	
● 1/2	SL1/2C8E2
● 3/4	SL3/4C8E2
● 5/6	SL5/6C8E2
● 17/18	SL17/18C8E2

Gracey 13/14	
● Standard	SG13/14C8E2
● Rigid	SG13/14RC8E2
● After Five	SRP13/14C8E2
● After Five Rigid	SP13/14RC8E2
● Mini Five	SAS13/14C8E2
● Mini Five Rigid	SS13/14RC8E2
Gracey 15/16	
● Standard	SG15/16C8E2
● Rigid	SG15/16RC8E2
● After Five	SRP15/16C8E2
● After Five Rigid	SP15/16RC8E2
● Mini Five	SAS15/16C8E2
● Mini Five Rigid	SS15/16RC8E2
Gracey 17/18	
● Standard	SG17/18C8E2
● Rigid	SG17/18RC8E2
Gracey 11/14	
● Standard	SG11/14C8E2
Gracey 12/13	
● Standard	SG12/13C8E2



Scaler and Curette Sets

We offer a wide variety of Scaler and Curette Sets including McCall, Goldman-Fox, and Cattoni. All scalers and curettes included in these sets are available in multiple handle options.

McCall Scalers and Curettes

McCall Scalers and Curettes are posterior instruments featuring dual cutting edges and available with either a rounded or pointed toe.



McCall 11/12 Scaler	
#6	SM11/126
#7	SM11/127
#8, Gray	SM11/128
#2	SM11/12



McCall 11/12A Scaler	
#6	SM11/12A6
#2	SM11/12A



McCall 11/12 Thin Scaler	
#6	S11/12S6

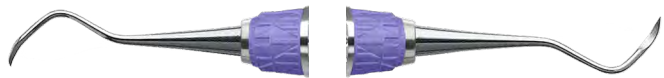

McCall 13/14 Curette	
Harmony	SM13/14SXE2
#9	SM13/149E2
#G9, Steel Grip	SM13/14G9E2
#C8, Lavender	SM13/14C8E2
#6	SM13/146
#7	SM13/147
#8, Gray	SM13/148
#2	SM13/14



McCall 13/14 Pointed Curette	
Harmony	SM13/14SXE2
#9	SM13/14S9E2
#G9, Steel Grip	SM13/14SG9E2
#C8, Lavender	SM13/14SC8E2
#6	SM13/14S6
#8	SM13/14S8
#7	SM13/14S7
#2	SM13/14S



McCall 13/14 Pointed Curette, Extended Blade
#6 **SMTC13/146**



McCall 17/18 Pointed Curette
#9 **SM17/18PT9E2**
#6 **SM17/18PT6**
#2 **SM17/18PT**



McCall 17/18 Curette
Harmony **SM17/18XE2**
#9 **SM17/189E2**
#G9, Steel Grip **SM17/18G9E2**
#C8, Lavender **SM17/18C8E2**
#6 **SM17/186**
#7 **SM17/187**
#8, Gray **SM17/188**
#2 **SM17/18**

Goldman-Fox Scalers and Curettes

Goldman-Fox Scalers have robust, elongated shanks for the removal of moderate to heavy calculus deposits.



Goldman-Fox #1 Universal Scaler
#6 **SGF16**



Goldman-Fox #2 Anterior Scaler
#6 **SGF26**

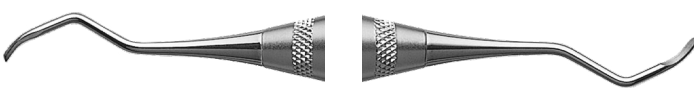

Goldman-Fox #3 Posterior Scaler
#6 **SGF36**



Goldman-Fox #4 Anterior Scaler
#6 **SGF46**



Goldman-Fox #21 Scaler/Spoon
#6 **SGF216**



Goldman-Fox/Jacquette Mini Scaler
#6 **SGF21S/33**



Cattoni Scalers

Cattoni Scalers are sets designed for optimal removal of moderate to heavy supra and subgingival calculus.



Cattoni 103/106 Scaler

#6 [S103/1066](#)



Cattoni 104/105 Scaler

#6 [S104/1056](#)



Cattoni 107/108 Scaler

#6 [S107/1086](#)
#7 [S107/1087](#)
#8 [S107/1088](#)

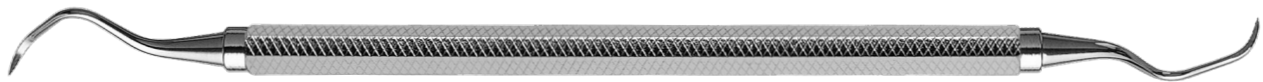

Cattoni 107/108 Slim Scaler

#2 [S107/108S](#)

Files and Hoes

Files and Hoes are specialty instruments used to dislodge or crush and remove heavy calculus deposits.

Hoe Scalers

Hoe Scalers are used to dislodge heavy supragingival calculus using a pull stroke.



Orban 6/7 Mesial-Distal Hoe Scaler
 #6 [SO6/76](#)
 #2 [SO6/7](#)



Orban 8/9 Buccal-Lingual Hoe Scaler
 #6 [SO8/96](#)
 #2 [SO8/9](#)



Centennial Anterior Sickle/Hoe Scaler
 #9 [SDH1009E2](#)
 #C8, Lavender [SDH100C8E2](#)



File Scalers

File Scalers have multiple cutting edges and are used to crush and remove heavy hard deposits using a pull stroke.



Orban 10/11 Buccal-Lingual File
#6 **FO10/116**
#2 **FO10/11**



Orban 12/13 Mesial-Distal File
#6 **FO12/136**
#2 **FO12/13**



Hirschfeld 3/7 Buccal-Lingual File
#6 **FH3/76**
#2 **FH3/7**



Hirschfeld 5/11 Mesial-Distal File
#6 **FH5/116**
#2 **FH5/11**



Hirschfeld 9/10 Anterior File
#6 **FH9/106**
#2 **FH9/10**



Chisels

Chisels are designed to dislodge bridges of calculus, using a push stroke, on anterior mandibular teeth.



Cushing #61 Chisel, Single-End

#24

SCU61



Cushing #62 Chisel, Single-End

#24

SCU62



Darby-Perry 5K/6K Chisel

#2

SDP5/6K



Darby-Perry 9K/11K Chisel

#2

SDP9/11K

DiamondTec™ File Scalers

DiamondTec™ File Scalers offer 360° of diamond coated coverage. The absence of blade edges allows use of all sides of the working end. Ideal for furcations, root depressions, mesial/distal line angles and developmental grooves.



DiamondTec™ Mesial Distal File Scaler

#2

SDCM/D7



DiamondTec™ Nabors File Scaler

#2

SDCN7



Empowerment Kit

The perfect set of scalers and curettes to enhance the effectiveness of your power scaling treatment protocols.



Learn more about the [Empowerment Kit](#).

Empowerment Kit	POWCOMPKIT
Small Cassette - 8 Instrument, Purple	IMN5084
Gracey 11/12 Thin Curette, #9 Handle, Orange	SG11/12PC9E2
Nevi™ 4 Thin Scaler, #9 Handle, Red	SCNEVI4LPC9E2
Gracey 1/2 Thin Curette, #9 Handle, Grey	SG1/2PC9E2
Younger-Good 7/8 Thin Scaler, Black	SYG7/8PC9E2
Gracey 13/14 Thin Curette, #9 Handle, Blue	SG13/14PC9E2
Nevi™ 1 Thin Scaler, #9 Handle, Purple	SCNEVI1LPC9E2
Gracey 7/8 Thin Curette, #9 Handle, Green	SG7/8PC9E2
#11/12 ODU DE Explorer	EXD11/126



Empowerment Scalers and Curettes

Empowerment Scalers and Curettes feature blades that are an average of 10% thinner for easier access to tight interproximal and subgingival spaces. EverEdge™ 2.0 Empowerment Scalers and Curettes are color-coded for easy identification.



Nevi™ 1 Thin Scaler
#9, Purple [SCNEVI1LPC9E2](#)



Nevi™ 4 Thin Scaler
#9, Red [SCNEVI4LPC9E2](#)



Younger-Good 7/8 Thin Scaler
#9, Black [SYG7/8PC9E2](#)



Gracey 1/2 Thin Curette
#9, Gray [SG1/2PC9E2](#)



Gracey 1/2 After Five Thin Curette
#9, Gray [SRPG1/2PC9E2](#)



Gracey 7/8 Thin Curette
#9, Green [SG7/8PC9E2](#)



Gracey 11/12 Thin Curette
#9, Orange [SG11/12PC9E2](#)



Gracey 13/14 Thin Curette
#9, Blue [SG13/14PC9E2](#)



Gracey 15/16 After Five Thin Curette
#9, Orange [SRPG15/16PC9E2](#)



Langer 3/4 Thin Curette
#9, Purple [SL3/4PC9E2](#)

Sidekick™ Sharpener	A302
Diamond Sharpening Cards	A304
Stones	A305
Arkansas	A305
India	A306
Ceramic	A306
Composition Stones	A307
Accessories	A308
Large-Scale Instrument Models	A309
Large-Scale Sharpening Stone Plastic Models	A309

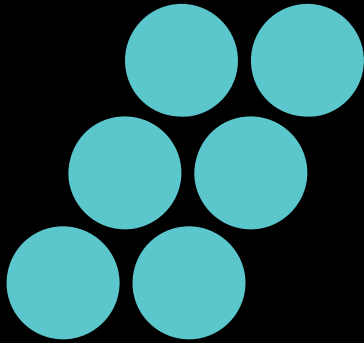

Instrument Maintenance

Regular maintenance is vital to longevity and performance of Instruments. Scalers and curettes should be kept sharp and true to their original design. Dental procedures are most effective when using sharp instruments because they reduce fatigue, improve deposit removal, save time, enhance tactile sensitivity, and minimize patient discomfort.



Sidekick™ Sharpener

The Sidekick™ Sharpener is designed for routine maintenance sharpening of scalers and curettes. Instrument guide channels help control blade angulation, providing consistent sharpening results. Requiring 2 AA batteries, Sidekick is compact and cordless, allowing for use anywhere in the dental office.



Learn more about our
[Sidekick™ Sharpener.](#)



SideKick™ Sharpener Kit

[SDKKIT](#)

Sidekick™ Replacement Stones

Arkansas Fine Grit [SDKSTONEA](#)

Ceramic Medium Grit [SDKSTONEC](#)

Ceramic Coarse Grit [SDKSTCOARS](#)

Sidekick™ Replacement Guide Plate

[SDKGPLATE](#)

Sidekick™ Replacement Screw

[SDKGPSCREW](#)

Sidekick™ Replacement Stoneclip

[SDKCLIP](#)

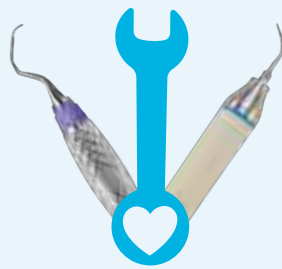

EverCare
SERVICE AND REPAIRS



Let Us Take Care of the Maintenance

EverCare Service & Repairs is the new, full-service offering designed to keep your dental instruments and PWR devices running smoothly.



Save time and money by letting the experts service your instruments and units



Fast turnaround time from when we get your products to when we ship them back



Real-time online status tracking to keep you in the know about progress



Unparalleled service quality as your instruments and units are serviced by skilled artisans



Flexible membership options choose a-la-carte or all-inclusive

Enroll today at EverCareService.com

All company and product names are trademarks of Hu-Friedy Mfg. Co., LLC its affiliates or related companies, unless otherwise noted. Marks not registered in all jurisdictions.
©2025 Hu-Friedy Mfg. Co., LLC. All rights reserved. 2506

 **HuFriedyGroup**
The Best in Practice



Diamond Sharpening Cards

Diamond Sharpening Cards feature a uniform coating of industrial diamonds bonded to a stainless steel card providing a hard, flat sharpening surface that resists ditching and grooving. They also feature easy clean-up via ultrasonic cleaner and steam sterilization.



Learn more about our [Diamond Sharpening Cards](#).



Diamond Sharpening Cards Set
Includes 1 each: Extra Fine, Fine and Medium Grip Diamond Sharpening Card.

DSCSET

Diamond Sharpening Cards

Extra Fine Grit	DSCXFINE
Fine Grit	DSCFINE
Medium Grit	DSCMED

Stones

From Extra Fine to Coarse grit levels, HuFriedyGroup offers a complete selection of natural and synthetic sharpening stones to help you maintain the perfect edges on your dental instruments.

Arkansas

Natural Arkansas stones are available in fine and super fine grits - ideal for daily sharpening of dental instruments. Arkansas stones should be coated with a thin layer of sharpening oil prior to use in order to prevent clogging and ensure top performance. Arkansas Stones can range in color from a solid grey to a marbled light grey or white.



Arkansas Stone Sharpening Kit	SSKITA
#4 Flat Arkansas Stone, Fine Grit	SS4
#299 Arkansas Conical Stone, Super Fine Grit	SS299
Plastic Test Stick, 6 Pack	PTS
Sharpen-Ez Stone Oil, 1 fl.oz.	SSO
Magnifying Lens Credit Card Size	LENS
HVESOLO™ Disposable Evacuation Tips (2.5" length)	1808S



#AS-22 Arkansas Stone, Super Fine Grit
SSAS22



#4 Flat Arkansas Stone, Fine Grit
SS4



#5 Bates Arkansas Stone, Fine Grit
SS5



#6A Arkansas Stone (Wedge), Fine Grit
SS6A



#2 Arkansas Cylindrical Stone, Super Fine Grit
SS2



#299 Arkansas Conical Stone, Super Fine Grit
SS299



India

India or I-Stones are synthetic stones available in fine and medium grits. I-stones can be lubricated with water prior to use or can be used dry.



#1 I-Stone, Fine Grit
SSF1



#6 I-Stone (Wedge) Medium Grit
SS6



#22 I-Stone, Medium Grit
SSMS22



#309 I-Stone, Tapered, Fine Grit
SS309

Ceramic

Hard synthetic stones available in fine, medium and coarse grits. Excellent for routine sharpening of dental instruments. Use water for lubrication or may be used dry.



Ceramic Stone Sharpening Kit	SSKITC
#3 Ceramic Stone, Medium Grit	SS3C
Ceramic Cylindrical Stone, Fine Grit	SSKC
Plastic Test Stick, 6 Pack	PTS
Magnifying Lens Credit Card Size	LENS



Dual Grit Ceramic Stone
Features a coarse side for recontouring and a finer side for finishing and honing.
SSDGRIT



#3 Ceramic Stone, Medium Grit
SS3C



Ceramic Cylindrical Stone, Fine Grit
SSKC



Ceramic Cylindrical Stone for Luxating Elevators, Fine Grit
SSLUX

Composition Stones

Composition stones are coarse aluminum oxide mandrel mounted stones for the handpiece, designed to restore the cutting edge on dull instruments.



Learn more about our [Composition Sharpening Stones](#).



#300 HP Composition Stone
(6 x 6mm) at base
SS300



#301 HP Composition Stone
(6 x 10mm) diameter
SS301



#302 HP Composition Stone
(3 x 3mm) diameter
SS302



#303 HP Composition Stone
(6 x 13mm) diameter
SS303



#304 HP Composition Stone
(6 x 16mm) diameter
SS304



#305 HP Composition Stone
(6 x 19mm) diameter
SS305



Accessories



Carbon Steel File Sharpener
FS



Carbon Steel Tanged File Sharpener
FST



Magnifying Lens Credit Card Size
LENS



Sharpen-Ez Stone Oil, 1 fl.oz.
SSO



Stainless Steel Pumice Cup
PCUPM



Plastic Test Stick
QTY: 1 **PTS-IND**
QTY: 6 **PTS**

Measuring Cup with 25ml Markings
MCUPE

Large-Scale Instrument Models

Used to help familiarize students with critical instrument surfaces, designs, and develop a better understanding of their application and maintenance. Models are 12" (30.5 cm) high.

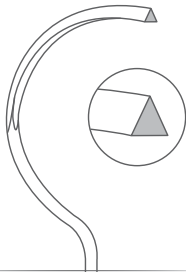

All large scale models are also available in cross section

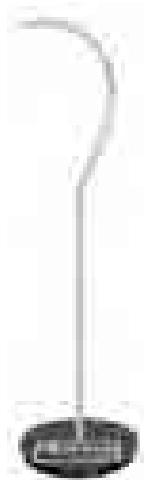

#H6 Sickle Scaler
LSMH6



#13 Columbia Curette
LSM13



#14 Gracey Curette
LSM14

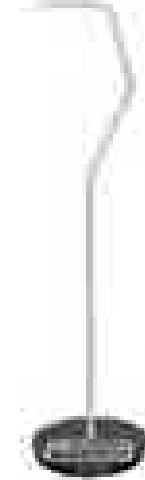

#30 Jacquette
LSM30

Large-Scale Sharpening Stone Plastic Models



Plastic Test Stick
11-1/2"
(29.2 cm)
LPTS



#4 Sharpening Stone
3" x 11" x 7-1/2"
(7.6 x 28 x 19 cm)
LSS4

Prophy Angles **A402**

Twist™ Prophy Angles A402

Sparkle™ Prophy Angles A403

Sparkle™ EZ Contra Prophy Angles A403

Twist™ Plus Prophy Angles A404

Prophy Paste **A406**

Sparkle™ Prophy Paste A406

Sparkle™ FREE Prophy Paste A407

Fluoride Treatments/Varnish **A408**

Sparkle V™ Fluoride Varnish A408

Zap™ Fluoride Gel Trays A409

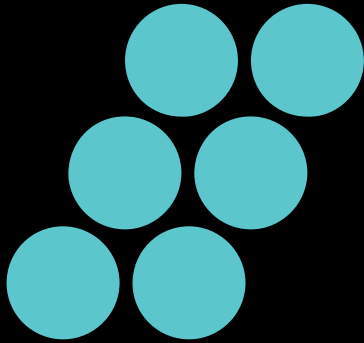

Procedural

Preventive care is critical to the success of a dental practice. That's why we created our procedural line of preventive products. Designed with both professionals and patients in mind, more hygienists choose our procedural products as they offer superior patient comfort. Choose our Twist™ Plus Prophy Angles that provides a smooth, splatter-free cleaning experience or our traditional, ergonomic, smooth-running Sparkle™ Prophy Angles. Compliment this with our patient-pleasing Sparkle V™ Varnish and Sparkle™ and Sparkle™ FREE Prophy Pastes.



Our Prophy Angles are designed with the clinician in mind. With a variety of angle and brush options, including the revolutionary Twist line of prophy angles, there is a DPA for every patient and hygienist.



Learn more about our [Prophy Angles](#).

Twist™ Prophy Angles

The original Twist™ Prophy Angle features an ergonomically designed angle that provides a 90° reciprocating “back and forth” rotating motion for continuous contact. This smooth back and forth motion reduces frictional heat build-up, keeping the tooth surface cooler and reduces splatter. The soft web cup and ribbed flair edges provides easy application and spreading of prophy paste.



Twist™ Prophy Angles	
Qty. 100	
Firm Cup	TPAFC
Soft Cup	TPASC
Tapered Brush	TPATB
Flat Brush	TPAFB



Sparkle™ Prophy Angles

Created with hygienists' feedback, the Sparkle™ Prophy Angles features a patented beveled gear design that runs vibration-free/noise-free; a flared cup design that improves subgingival access and reduces spatter, a light colored angle with dark colored cup provides greater visibility



Sparkle™ Prophy Angle	
Qty. 100	
Firm	TPASFC1
Soft	TPASSC1
Tapered Brush	TPATBC1

Sparkle™ Prophy Angle	
Qty. 500	
Firm	TPASFC5
Soft	TPASSC5

Sparkle™ EZ Contra Prophy Angles

Advanced ergonomic design reduces hand fatigue and allows for greater access. Provides all additional benefits of the Sparkle™ Prophy Angle.



Sparkle™ EZ Contra Angle	
Qty. 100	
Firm	TPAFEZ
Soft	TPASEZ



Twist™ Plus Prophy Angles

The new ergonomic design of the Twist™ Plus Prophy Angle improves handling and reduces spatter. The robust gear mechanism provides a smooth, continuous motion. A recessed grip enhances the ergonomics of the angle providing a secure and comfortable grasp. The smaller head improves visibility and increases maneuverability. Enhanced cup fluting improves interproximal application 120° reciprocating motion allows for continuous-contact polishing.



Twist™ Plus Prophy Angles

Qty. 100

Firm Cup

TPLUSPAFC

Soft Cup

TPLUSPASC

Tapered Brush

TPLUSPATB

Twist™ Plus

Oscillating Disposable Prophy Angles



**Less splatter.
Less frictional heat.**

The Twist™ Plus Oscillating Disposable Prophy Angles are the ONLY disposable prophy angle that oscillate 120° in a smooth, continuous counter-rotational motion to eliminate the splatter and frictional heat associated with traditional 360° spinning prophy angles.



Visit us online at [HuFriedyGroup.com/Twist-Plus](https://www.HuFriedyGroup.com/Twist-Plus)

HuFriedyGroup
The Best In Practice



Prophy Paste

Our Prophy Paste was designed with clinicians and patients in mind. With a wide variety of flavors and two formula options, regular formula and a formula free of tree nuts and other allergens, there's an option for everyone.



Learn more about our [Prophy Pastes](#).

Sparkle™ Prophy Paste

Formulated to maximize stain removal with minimal enamel loss, Sparkle™ Prophy Paste has an advanced formulation that provides consistent, splatter-free results. Sparkle™ Prophy Paste also completely rinses out, leaving no residual grit.



Coarse Grit, Mint	
12oz/340gr, Qty.1, Jar	UPC12
Course Grit	
Qty. 200	
Assorted	UPCA
Berrylicious	UPCB
Bubblegum	UPCBG
Cherry	UPCCH
Mint	UPCM
Orange Vanilla	UPCOV
Medium Grit	
Qty. 200	
Bubblegum	UPFBG
Assorted	UPMA
Berrylicious	UPMB
Bubblegum	UPMBG
Cherry	UPMCH
Mint	UPMM
Orange Vanilla	UPMOV



Sparkle™ FREE Prophy Paste

Sparkle™ FREE Prophy Paste includes all the benefits of Sparkle™ Prophy Paste in a unique fluoride/dye free formula. Available in multiple grits and flavors, Sparkle™ FREE Prophy Paste is free of tree nuts, soy, milk, eggs, gluten, aspartame, sulfite and corn products.



Course Grit	
Qty. 200	
Cinnamon	UPSFCC
Fruity	UPSCFC
Spearmint	UPSFCS
White Chocolate	UPSCWC
Medium Grit	
Qty. 200	
Cinnamon	UPSFMC
Fruity	UPSFMF
Spearmint	UPSFMS
White Chocolate	UPFMWC



Fluoride Treatments/ Varnish

Fluoride is an essential part of the hygiene procedure and we are proud to offer two convenient, easy-to-apply options when it comes to Fluoride Varnish.



Learn more about our [Fluoride Treatments/Varnish](#).

Sparkle V™ Fluoride Varnish

Sparkle V™ Fluoride Varnish with Xylitol is a convenient, easy-to-apply, single-dose fluoride varnish with minimal set-up and clean-up time, and smooth consistency. This fluoride sets fast, even in the presence of saliva for easy application and dries to a natural tooth shade for patient satisfaction. Available in five popular flavors.



Sparkle V™ Fluoride Varnish	
Qty: 120	
Melon	UFVML
Cherry	UFVCY
Mint	UFVM
Bubblegum	UFVBG
Caramel	UFVCA



Zap™ Fluoride Gel Trays

Soft, anatomical design for comfortable, natural fit Buckle ridges improve Fluoride access to teeth 3 color-coded sizes for easy identification Long, interlocking handles for ease of application Unique “space-saver” package for easy access and storage

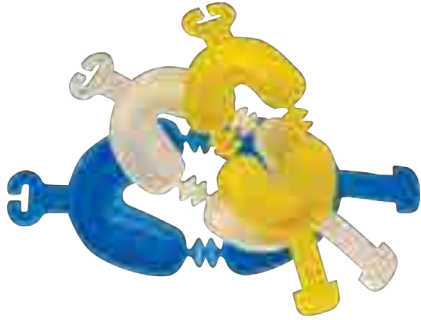

Gel Tray, Hinged	
Small	YFTHS
Medium	YFTHM
Large	YFTHL

Implacare™ Titanium Scalers

A502

Implacare™ II Scalers

A503

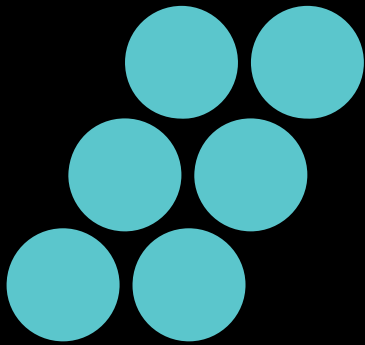

Implant Maintenance

Be **The Best in Practice** with our selection of implant maintenance instruments. From Titanium Scalers to Implacare™ II Removable Tips, we have a solution for your individual implant maintenance procedures.



Implacare™ Titanium Scalars

Titanium Implant Scalars are made from the same titanium alloy as implants and abutments for implant maintenance, debridement and biofilm removal. These instruments feature increased visibility from teal colored anodized titanium, optimized sharpness with finely honed cutting edges, and the ability to be sharpened to increase the useful life.



Learn more about all our
[Implant Maintenance](#) products.



Titanium Implant Scaler 204SD
IMP204SDT



Titanium Implant Scaler Langer 1/2
IMPLG1/2T



Titanium Implant Scaler Mini Five 1/2
IMPM1/2T



Titanium Implant Scaler Mini Five 11/12
IMPM11/12T



Titanium Implant Scaler Mini Five 13/14
IMPM13/14T



Implacare™ II Scalers

Implacare™ II Scalers, made of Plasteel™ Resin, provide thinner working ends and designs that allow you to better adapt to and effectively scale implants while causing the least amount of alteration to implant abutment. Five tip designs provide options best suited for individual scaling needs.

Scaling with Implacare II caused the least alteration to the abutment surface

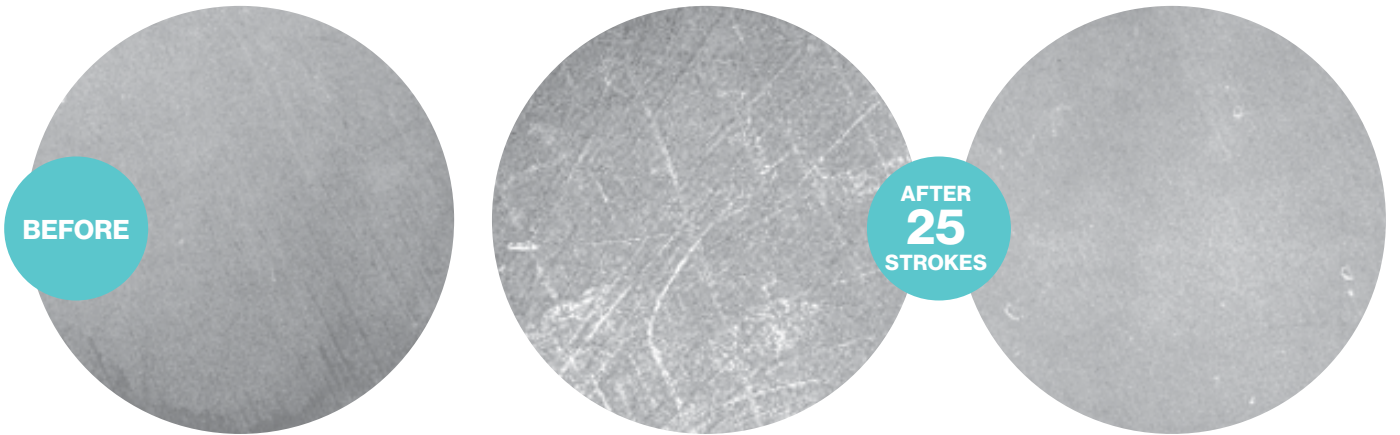

Original Titanium Abutment Magnified

Plastic Material Containing Abrasives

Implacare II Tip made with Plasteel™ Resin

Titanium abutment images are from the International Journal of Oral & Maxillofacial Implants study. Hallmon WW, Waldrop TC, Meffert RM, Wade BW. INT J ORAL MAXILLOFAC IMPLANTS 1996;11:96-100.



IMPLACARE® II Scalers

For implant maintenance, Implacare II is used to remove plaque and calculus with the least amount of alteration to titanium abutments.¹



Implacare™ II Columbia 4R/4L Curette
12 Pair Refill Pack [IMPL4R/4L](#)

Implacare™ II Columbia 4R/4L Curette Kit
Handle + 12 Pair Refill Pack [IMPL4R/4L6](#)



Implacare™ II Langer 1/2 Scaler
12 Pair Refill Pack [IMPLLG1/2](#)

Implacare™ II Langer 1/2 Scaler Kit
Handle + 12 Pair Refill Pack [IMPLLG1/26](#)



Implacare™ II Barnhart 5/6 Scaler
12 Pair Refill Pack [IMPLBH5/6](#)

Implacare™ II Barnhart 5/6 Scaler Kit
Handle + 12 Pair Refill Pack [IMPLBH5/66](#)



Implacare™ II H6/7 Scaler
12 Pair Refill Pack [IMPLH6/7](#)

Implacare™ II H6/7 Scaler Kit
Handle + 12 Pair Refill Pack [IMPLH6/76](#)



Implacare™ II 204S Scaler
12 Pair Refill Pack [IMPL204S](#)

Implacare™ II 204S Scaler Kit
Handle + 12 Pair Refill Pack [IMPL204S6](#)

¹Hasturk H, Huy Nguyen D, Sherzai H, Song X, Soukos N, Bidlack F, Van Dyke T. Comparison of the Impact of Scaler Material Composition on Polished Titanium Implant Abutment Surfaces. Journal of Dental Hygiene. 2013;87(4)



Implacare™ II Scaler Kit with Handle + 12 Pair Tip Assortment **IMPLSORT6**

- 1 Implacare™ II Handle
- 4 Columbia 4R/4L pairs
- 4 204S pair
- 4 H6/H7 pair



Implacare™ II Scaler Intro Kit with Handle + 5 Pair Tip Assortment **IMPLINTRO6**

- 1 Implacare™ II Handle
- 1 Columbia 4R/4L pair
- 1 204S pair
- 1 H6/H7 pair
- 1 Barnhart 5/6 pair
- 1 Langer 1/2 pair



Implacare™ II Tip Refill Pack with 12 Pair Tip Assortment **IMPLSORT**

- 4 Columbia 4R/4L pairs
- 4 204S pairs
- 4 H6/H7 pairs



Implant Maintenance Kit **IMPCKITII**

- | Implacare II | Colorvue |
|------------------------------|--|
| 1 Implacare scaler handle | 1 Colorvue probe handle |
| 1 set of 204S scaler tips | 1 set of PCV11 tips (3-6-8-11) |
| 1 set of H6/H7 scaler tips | 1 set of PCV12 tips (3-6-9-12) |
| 1 set of Columbia 4R/4L tips | 1 set of Williams tips (1-2-3-5-7-8-9-10) |
| 1 set of Langer 1/2 tips | 1 set of UNC12 tips (1-2-3-4-5-6-7-8-9-10-11-12) |
| 1 set of Barnhart 5/6 tips | |

• Visit page A404 to view our full portfolio of Colorvue™ Probe.



Implacare™ Scaler - Satin Steel Handle
Handle **IMPHDL6**



• **The power is yours to choose piezo scaling for implant patients.**
• Learn more about PWR Piezo Scaling and its Implant Cleaning Tips by visiting [Page B202](#)

Collections & Kits	A602	Articulating & Occlusion Testing Materials	A642
Handles	A608	Carvers	A643
Composite Instruments	A610	Knives	A647
Minimally Invasive Instruments	A619	Burnishers	A649
Hatchets	A624	Matrix Strips	A651
Chisels	A626	Gingival Retractors	A652
Hoes	A627	Gingival Cord Packers	A653
Margin Trimmers	A628	Crowns	A655
Angle Formers	A630	Crown Removers	A659
Excavators	A631	Esthetic Instruments	A662
Placement Instruments	A635	Spatulas	A664
Pluggers & Condensers	A636	Mixing Pads	A667
Amalgam Carriers & Files	A640	Measuring Devices	A668
Articulating Paper Forceps	A641	Waxing Instruments	A670

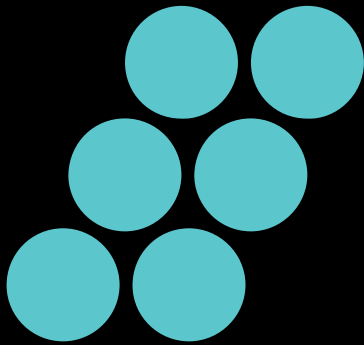

Restorative

Our goal is to help you be **The Best in Practice** and we look to do so by offering an extensive collection of quality-crafted Restorative products. We combine advanced technology and innovative design to produce superior products with optimal performance, maximum durability, and resiliency. We continuously strive to provide you with exceptional products and education, ideal for achieving remarkable aesthetic and functional results. Our comprehensive Restorative product line is continually growing as we discover products that aid you in delivering consistent, accurate, and predictable clinical outcomes.



Collections & Kits

World-renowned Key Opinion Leaders have curated numerous Restorative Collections & Kits to help you confidently carry out procedures. Our Collections & Kits include an IMS™ Cassette to help ensure your instruments are organized and protected throughout the facility, allowing you to go from chairside, to cleaning, to sterilization, to storage, without touching contaminated instruments.



Learn more about our [Restorative Collections & Kits](#).



Composite Kit	COMPKIT
#6 Cone Socket Mirror Handle	MH6
#5 HD Double-Sided Mirror	MIR5DS
18 Excavator, #6 Handle	EXC186
Goldstein Flexi-Thin #1, XTS™ Handle	TNCIGFT1
27/29 Burnisher	TNBB27/29
Goldstein Flexi-Thin, Extra-Flex #3, XTS™ Handle	TNCIGFT3
4/5 Gregg, XTS™ Handle	TNPFIG4/5
Interproximal Carver, XTS™ Handle	TNCVIPC
313 Mini Spatula/ Placer, #6 Handle	SP60616
Small Cassette - 10 Instrument, Black	IM5107

Minimally Invasive Kit	MININVKIT
Micro Placement	TNGMPI
#2 DE Excavator	EXCKOT2
#2 DE Burnisher	BBKOT2
4 IPC Carver	CVIPCKOT4
#23 Explorer	EXKOT23
#2 Kotschy	PFIKOT2
#2 DE Plugger Non-Serrated	PLGKOT2
Small Cassette - 10 Instrument, Black	IM5107

Basic Pediatric Kit	KIT-PEDO
#6 Cone Socket Mirror Handle	MH6
#4 HD Blackline Double-Sided Mirror	MIR4HD
Dressing Pliers, Utility Pick-Up	DPU17
#23 Explorer	EXS236
19 Excavator, #6 Handle	EXC196
Mini #1, XTS™ Handle	TNCIGFTMI1
Freedman Small Contact Forming	TNFCIS
313 Mini Spatula/ Placer, #6 Handle	SP60616
How Pliers	678-203
Crown & Band Contouring Pliers	678-221
Band Crimping Pliers	678-225
Crown & Gold Curved, Scissors, Pedo	SCGCP
Rubber Dam Clamp #W8A	RDCMW8A
Double-Decker™ Large Orthodontic Cassette, Blue	IM5208-OR



Stainless Steel Crowns Accessories Kit	SSCROWNKIT
19 Excavator, #6 Handle	EXC196
313 Mini Spatula/ Placer, #6 Handle	SP60616
#5 Front Surface Rhodium Single-Sided Mirror	MIR5
#6 Cone Socket Mirror Handle	MH6
Dressing Pliers, Utility Pick-Up	DPU17
Crown & Gold Curved, Scissors, Pedo	SCGCP
Crown & Band Contouring Pliers	678-221
How Pliers	678-203
Band Crimping Pliers	678-225
Large Thin Orthodontic Cassette, Blue	IMORTHLG8



Wren Kit	KIT-WREN
#6 Cone Socket Mirror Handle	MH6
#4 HD Double-Sided Mirror	MIR4HD
Dressing Pliers, Utility Pick-Up	DPU17
Combination #23 Shepherd's Hook and #6 DE Explorer, #6 Handle	EX23/66
Mini Three Jaw Pliers	678-312
How Pliers	678-203
Slim Crown & Band Contouring Pliers	678-221MC
Bird Beak Pliers	678-304
Marcotte Looping Pliers	678-316
Crown & Gold Curved, Scissors, Pedo	SCGCP
7 Wax Spatula	WS7
1T Tanner Plugger	PLG0T
Large Thin Orthodontic Cassette, Blue	IMORTHLG8





Rothman Kit	KIT-ROTH
#6 Cone Socket Mirror Handle	MH6
#4 HD Double-Sided Mirror	MIR4HD
Crown & Gold Curved, Scissors, Pedo	SCGCP
Band Crimping Pliers	678-225
How Pliers	678-203
Crown & Band Contouring Pliers	678-221
19 Excavator, #41 Handle	EXC19
#5 DE Explorer, #6 Handle	EXD56
3 Ladmore, #41 Handle	BBL3
Three Jaw Pliers	678-302
#2 Dressing Pliers (College)	DP2
Hard Wire Cutter Straight	678-104
Large Thin Orthodontic Cassette, Blue	IMORTHLG8

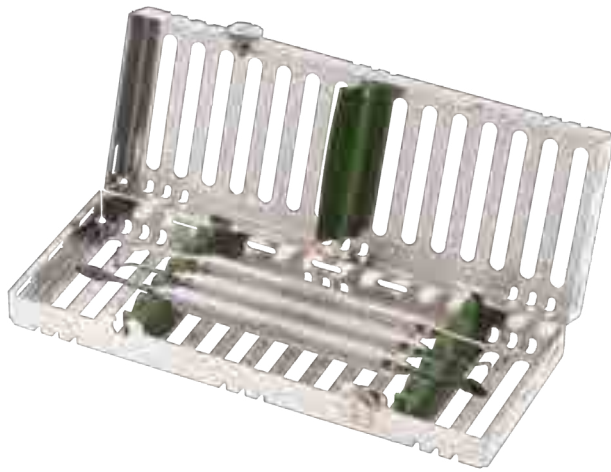

Milnar Kit	KIT-MILN
6 Hollenback DE, Milnar	CVHL66
B Cosmetic Contouring, XTS™ Handle	TNCCIB
Mini Extra-Flex #4, XTS™ Handle	TNCIGFTMI4
Exam Cassette - 5 Instrument, Green	IM6059



Adhesthetics Theca Kit by Federico Ferraris	TNFFCASS
Ferraris Main Shaper	TNFF1/2
Ferraris Fine Shaper/Cord Packer	TNFF3/4
Ferraris 3D Shaper	TNFF5/6
Ferraris Direct Caliper	TNFF7/8
Exam Cassette - 5 Instrument, Blue	IM6058



Learn more about our Key Opinion Leader **Federico Ferraris.**

WeRestore.it Kit	RESTOREITKIT
WeRestore.it Spatula	CVKOT1X
WeRestore.it Posterior	TNEXBKR1X
WeRestore.it Anterior	TNCIPA0X
Exam Cassette - 5 Instrument, Black	IMN6057



Learn more about our partnership with [WeRestore.it](#).



CompoSculp Instrument Kit, Smooth Handles	PFIDDCASS
Dietschi Composculp 1/2, Satin Steel™ Handle	PFIDD1/2
Dietschi Composculp 3/4, Satin Steel™ Handle	PFIDD3/4
Dietschi Composculp 5/6, Satin Steel™ Handle	PFIDD5/6
Dietschi Composculp 7/8, Satin Steel™ Handle	PFIDD7/8
Dietschi Composculp 9/10, Satin Steel™ Handle	PFIDD9/10
Exam Cassette - 5 Instrument, Orange	IM6053

CompoSculp Instrument Kit, Resin 8 Handles	PFIDDCASS8
Dietschi Composculp 1/2, #8 Resin Handle	PFIDD1/28
Dietschi Composculp 3/4, #8 Resin Handle	PFIDD3/48
Dietschi Composculp 5/6, #8 Resin Handle	PFIDD5/68
Dietschi Composculp 7/8, #8 Resin Handle	PFIDD7/88
Dietschi Composculp 9/10, #8 Resin Handle	PFIDD9/108
Exam Cassette - 5 Instrument, Orange	IM6053



Learn more about our Key Opinion Leader [Didier Dietschi](#).

Massironi Kit for Prosthodontic Procedures	MASSKITCASS
#1 DE Explorer, #6 Handle	EXD16
Cortellini, SE Laser Probe, 0.5-15	PCORTLINI
Spatula 350µ	CVIPCKOT4
Massironi 1.2 mm Spoon Chisel	TNMASS1
Massironi 1.5 mm Spoon Chisel	TNMASS2
1 Yardley Gingival Cord Packer	GCPYD1
BN1 Gingival Cord Packer	GCPBN1
32 Curved Semkin-Taylor Tissue Pliers	TP32
3 Curved Halsted-Mosquito Hemostat	H3
#6 Cone Socket Mirror Handle	MH6
#5 HD Single-Sided Mirror	MIR5HD
Small Cassette - 10 Instrument, Black	IM5107C2





Chu's Aesthetic Gauges™ Set, Satin Steel	SCHUSET
Proportion Gauge, Satin Steel™ Handle	PROGS
Crown Lengthening Gauge, Satin Steel™ Handle	CLGS
Sounding Gauge, Satin Steel™ Handle	SOUNDGS
Exam Cassette - 5 Instrument, Gray	IM6051

Chu's Aesthetic Gauges™ Set, Resin Handle	CHUSET
Proportion Gauge	PROG
Crown Lengthening Gauge	CLG
Sounding Gauge	SOUNDG
Exam Cassette - 5 Instrument, Gray	IM6051

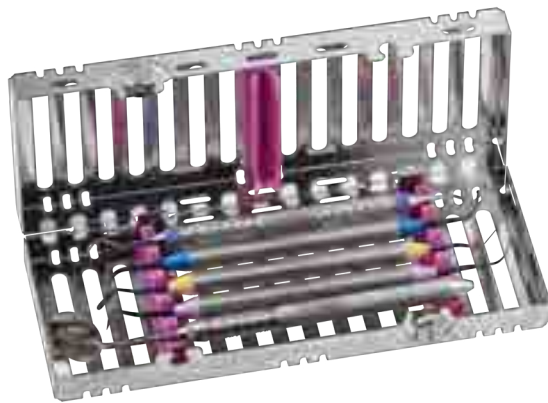

SkoolToolz Instrument Kit	TNTAMKIT
SkoolToolz, Posterior Occlusal Shaper	TNTAM1
SkoolToolz, Universal Thin PFI	TNTAM2
SkoolToolz, Curved Ball Burnisher	TNTAM3
204S Posterior Sickle Scaler, #9 Handle	S204S9E2
#5 HD Mirror, Cone Socket	MIR5HDE
#6 Cone Socket Mirror Handle	MH6
Exam Cassette - 5 Instrument, Pink	IM6056



Learn more about our Key Opinion Leader [Clarence Tam](#).

Bakeman Kit	KIT-BAKE
#4 HD Double-Sided Mirror	MIR4DSHD
#6 Cone Socket Mirror Handle	MH6
Qulix SE Probe, 3-6-9-12, #6 Handle	PCP126
#2 Dressing Pliers (College)	DP2
PR-3 Prichard Periosteal, #6 Handle	PPR36
#7 Mini Scalpel Blade Holder	10-130-70
#5 Scalpel Handle, Round Straight	10-130-05
3/4 Wedelstaedt	CP3/4
Columbia 4R/4L Curette, #6 Handle	SC4R/4L6
Perma Sharp Castro Needle Holder, Flat	NH5024
Castro Microsurgical Scissors	SPV
Small Cassette - 10 Instrument, Gray	IM5101

Tucker 8 Kit	TUCKERKIT
232 Tru Bal Margin Trimmer, #9 Handle	MT232TM9
233 Tru Bal Margin Trimmer, #9 Handle	MT233TM9
232 Tucker Margin Trimmer, #9 Handle	MT232TBM9
233 Tucker Margin Trimmer, #9 Handle	MT233TBM9
14/14-0 Off Angle, #9 Handle	CP14/14-09
15/15-0 Off Angle, #9 Handle	CP15/15-09
44S Off Angle Hatchet, #9 Handle	CP44S9
45S Off Angle Hatchet, #9 Handle	CP45S9
Exam Cassette - 8 Instrument, Green	IM5109



Anterior Kit	TNANTKIT
Goldstein Flexi-Thin, Extra-Flex #3	TNCIGFT3
Mini #1, XTS™ Handle	TNCIGFTMI1
Micro-Mini, XTS™ Handle	TNCIPCS
Medium Placing/Condensing	TNCIPCM
Large Placing/Condensing	TNCIPCL

Posterior Kit	TNPOSKIT
#0T Tanner Plugger	TNPLG0T
#3 Hollenback Carver, #41 Handle	TNPLGH3
XTS™ Amalgam Plugger	TNPLG5A
Small/Medium Contact Forming	TNCFIS/M
Medium/Large Contact Forming	TNCFIM/L

The_alphabet Kit	BIOKIT
Bio-Emulation™ Alpha	CIBIOA
Bio-Emulation™ Beta	CIBIOB
Bio-Emulation™ Delta	CIBIOD
Bio-Emulation™ Epsilon	CIBIOE
Bio-Emulation™ Gamma	CIBIOY
Bio-Emulation™ Zeta	CIBIOZ

Nash Taylor Esthetic Instrument Kit	NTEIK
Hinged Instrument Clips, 2 Pack	IM1000
Crown Spreader	CRSPR
#20 Esthetic, #6 Handle	CR206
#8 Wiland, #6 Handle	CVWI86
#1 Dressing Pliers (Perry)	DP1
44/45 Excavator, #6 Handle	EXC44/456
#23 Shepherd's Hook/#6 Explorer, #6 Handle	EX23/66
Inlay/Onlay	IL/OL
#6 Cone Socket Mirror Handle	MH6
#5 Front Surface Rhodium Single-Sided Mirror, QTY: 3	MIR5/3
Temporary Crown Remover	NASTACR
Interproximal Scaler	NTIPC
Interproximal Knife	NTIPK
8A Composite Instrument, #6 Handle	PFI8A6
Straight Veneer Stabilizer	VENSTABS
Curved Veneer Stabilizer	VENSTAB
#5 Scalpel Handle, Straight Round Handle	10-130-05
Large Cassette - 16 Instrument, Blue	IM4168





Handles

With finely crafted handle options, you can select various styles, sizes, textures, and materials that suit your needs. Our handles are engineered to stringent standards for optimal balance, comfort, and precision. All handles are available in double-end and single-end options.

Double-End

XTS™ Handle



#6 Satin Steel™ Handle



Smooth



#7 Satin Steel™ Colours™ Handle



#8 ResinEight™ Handle



#9 EverEdge™ Handle



#41 Round



Thin Smooth



A608



Single-End

#6 Satin Steel™ Handle



#7 Satin Steel™ Colours™ Handle



#8 ResinEight™ Handle



#40 Round



Thin Smooth





Composite Instruments

Our Composite Instruments are engineered to perfection with Aluminum Titanium Nitride coating to prevent scratching and sticking. The handles are large, yet lightweight, and made of Satin Steel™ Alloy for ease of comfort and control while allowing for an easy cleanup.



Learn more about our [Composite Instruments](#).



Akro-Flex™ Composite Instrument
Smooth [AKRO-FLEX](#)

Akro-Flex™ w/Signature 5-instr cassette
Includes AKRO-FLEX [AKRO-CASS](#) and IM6058



Learn more about the [Akro-Flex™ Composite Instrument](#).

Akro-Flex™ w/Infinity 5-instr cassette
Includes AKRO-FLEX [AKRO-INFIN](#) and IMN6058

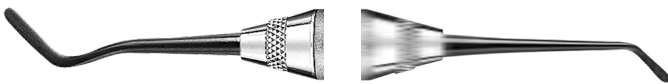

Goldstein Flexi-Thin #1
Class I, II, and III Restorations
XTS [TNCIGFT1](#)
#6 [CIGFT16](#)
#8 [CIGFT18](#)
#41 [CIGFT1](#)

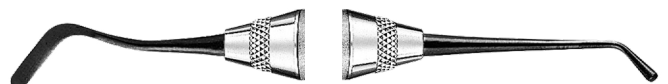

Goldstein Flexi-Thin #2
Class I, II, and III Restorations
XTS [TNCIGFT2](#)
#6 [CIGFT26](#)
#41 [CIGFT2](#)



Goldstein Flexi-Thin, Extra-Flex #3
Class I, II, and III Restorations
XTS [TNCIGFT3](#)
#6 [CIGFT36](#)
#8 [CIGFT38](#)
#41 [CIGFT3](#)



Learn more about our Key Opinion Leader [Ronald Goldstein](#).



Goldstein Flexi-Thin, Extra-Flex #4	
XTS	TNCIGFT4
#6	CIGFT46
#41	CIGFT4

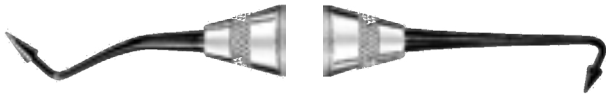

Goldstein Flexi-Thin #5	
XTS	TNCIGFT5
#41	CIGFT5

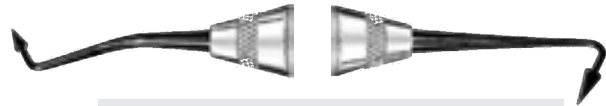

Goldstein Flexi-Thin #6	
XTS	TNCIGFT6
#41	CIGFT6



Micro-Mini Composite Instrument	
XTS	TNCIPCS



Mini #1 Composite Instrument	
XTS	TNCIGFTMI1
#6	CIGFTMIN16
#41	CIGFTMIN1



Mini Extra-Flex #3 Composite Instrument	
XTS	TNCIGFTMI3
#6	CIGFTMIN36
#8	CIGFTMIN38
#41	CIGFTMINI3



Mini Extra-Flex #4 Composite Instrument	
XTS	TNCIGFTMI4
#6	CIGFTMIN46
#8	CIGFTMIN48
#41	CIGFTMINI4



Micro Placement Composite Instrument	
Smooth	TNGMPI



AB1 Boghosian Composite Instrument
Class III, IV, and V Restorations

XTS	TNPFIA1
#41	PFIA1
#6	PFIA16



AB2 Boghosian Composite Instrument

XTS	TNPFIA2
#41	PFIA2

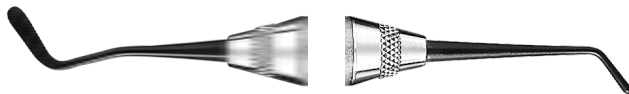

W3 Composite Instrument
Class I, II, III, IV and V Restorations

XTS	TNPFIW3
#6	PFIW36
#8	PFIW38
#41	PFIW3



8A Composite Instrument

XTS	TNPFIA8A
#6	PFIA8A6
#41	PFIA8A



4/5 Gregg Composite Instrument
Class II and V Restorations

XTS	TNPFIA4/5
#41	PFIA4/5



A6 Composite Instrument
Class II, III, IV and V Restorations

XTS	TNPFIA6
#6	PFIA66
#7	PFIA67
#8	PFIA68
#41	PFIA6

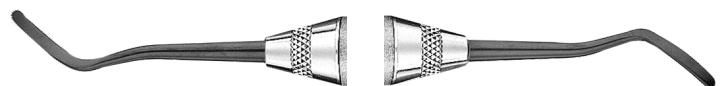

Contouring Instrument

XTS	TNCFIR/L
-----	-----------------



Freedman Small Contact Forming
Class II Restorations
 XTS TNFCIS



Freedman Large Contact Forming
Class II Restorations
 XTS TNFCIL



A Cosmetic Contouring Instrument
 XTS TNCCIA
 #10 CCIA



B Cosmetic Contouring Instrument
 XTS TNCCIB
 #10 CCIB



C Cosmetic Contouring Instrument
 XTS TNCCIC
 #10 CCIC



D Cosmetic Contouring Instrument
 XTS TNCCID
 #10 CCID

E Cosmetic Contouring Instrument
 XTS TNCCIE
 #10 CCIE



Composite Instruments

Restorative



F Cosmetic Contouring Instrument

XTS

TNCCIF

#10

CCIF

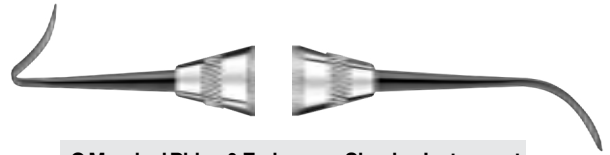

G Marginal Ridge & Embrasure Shaping Instrument

XTS

TNCCIG

#10

CCIG

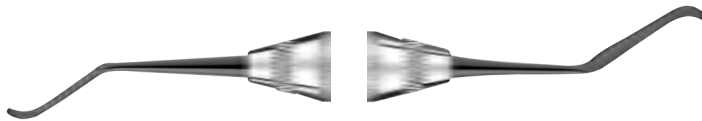

H Occlusal Anatomy Instrument

XTS

TNCCIH

#10

CCIH



I Composite Packing Instrument

XTS

TNCCII

#10

CCII

Refer to [page A607](#) for a detailed listing of our [Anterior Kit \(TNANTKIT\)](#) and [Posterior Kit \(TNPOSKIT\)](#).



SkoolToolz, Posterior Occlusal Shaper

Smooth

TNTAM1



SkoolToolz, Universal Thin PFI

Smooth

TNTAM2

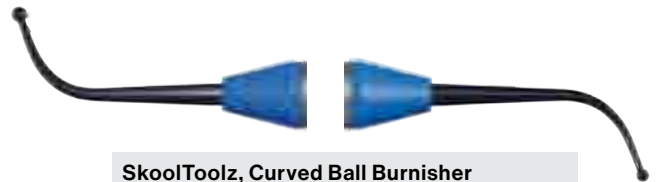

SkoolToolz, Curved Ball Burnisher

Smooth

TNTAM3

Refer to [page A606](#) for a detailed listing of the [SkoolToolz Instrument Kit \(TNTAMKIT\)](#).



Ferraris Main Shaper

Smooth

TNFF1/2

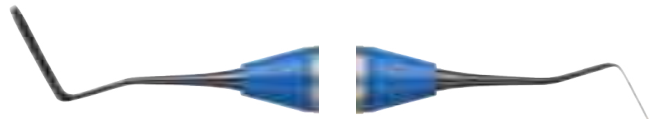

Ferraris Fine Shaper/Cord Packer

Smooth

TNFF3/4



Ferraris 3D Shaper

Smooth

TNFF5/6



Ferraris Direct Caliper

Smooth

TNFF7/8

Refer to [page A604](#) for a detailed listing of the [Adhesthetics Theca Kit by Federico Ferraris \(TNFFCASS\)](#).



WeRestore.it Spatula
Smooth **CVKOT1X**



WeRestore.it Calibra
Smooth **TNCALIBRA**



WeRestore.it Anterior
Smooth **TNCIPAOX**

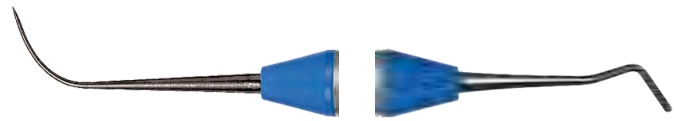

WeRestore.it Posterior
Smooth **TNEXBKR1X**

Refer to [page A605](#) for a detailed listing of the [WeRestore.it Kit \(RESTOREITKIT\)](#).



Large Placing/Condensing XTS™ Composite Instrument
Class I and II Restorations
XTS **TNCIPCL**



Medium Placing/Condensing XTS™ Composite Instrument
XTS **TNCIPCM**

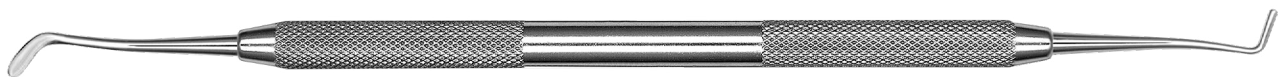

3 PFI/Tufts Composite Instrument
Class I, II, III, IV and V Restorations
CI6001



4 PFI/Tufts Composite Instrument
Class III and IV Restorations
CI6056



11 Composite Instrument
#6 **PFI116**
#41 **PFI11**



179 Composite Instrument
#41 **PFI179**

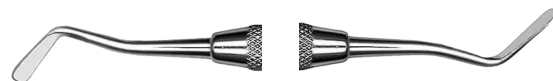

G Composite Instrument
#41 **PFIG**



Composite Instruments

Restorative



1/2 Trico Composite Instrument

#41 **PFITR1/2**



DPT6 SE Trimmer Plastic

#41 **PFIDPT6**

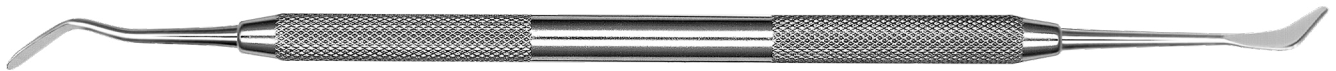

W1 Composite Instrument

#41 **PFIW1**

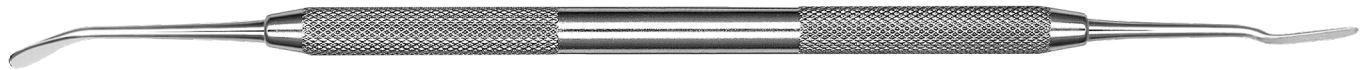

1 Woodson Composite Instrument

#6 **PFIWDS16**

#41 **PFIWDS1**



Dietschi Composculp 1/2

Smooth **PFIDD1/2**

#8 Resin Handle **PFIDD1/28**



Dietschi Composculp 3/4

Smooth **PFIDD3/4**

#8 **PFIDD3/48**



Dietschi Composculp 5/6

Smooth **PFIDD5/6**

#8 **PFIDD5/68**



Dietschi Composculp 7/8

Smooth **PFIDD7/8**

#8 **PFIDD7/88**



Dietschi Composculp 9/10

Smooth **PFIDD9/10**

#8 **PFIDD9/108**

Refer to [page A605](#) for a detailed listing of the **CompoSculp Instrument Kit, Smooth Handles (PFIDDCASS)** and the **CompoSculp Instrument Kit, Resin 8 Handles (PFIDDCASS8)**.

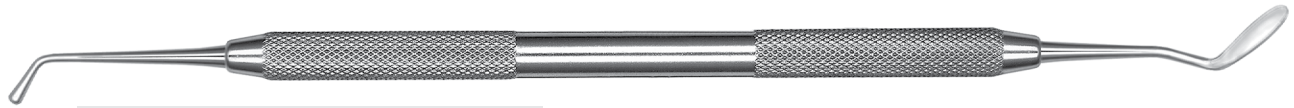

1 Hu-Friedy Composite Instrument
#41 **PFIHF1**



2 Hu-Friedy Composite Instrument
#41 **PFIHF2**



49 Baldwin Composite Instrument
#41 **PFI49**



1 Woodson Composite Instrument
#6 **PFIWDS16**
#41 **PFIWDS1**

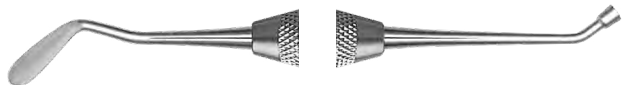

2 Woodson Composite Instrument
#6 **PFIWDS26**
#41 **PFIWDS2**



3 Woodson Composite Instrument
#41 **PFIWDS3**



1 Loesche Composite Instrument
Class I, II, and V Restorations
#41 **PFIGML1**



2 Loesche Composite Instrument
Class I, II, and V Restorations
#6 **PFIGML26**
#41 **PFIGML2**



Composite Instruments

Restorative



1 Composite Instrument

#41	PF11
#6	PF116



BEQ1 Quéting Composite Instrument

#7	PFIBEQ17
#41	PFIBEQ1



Bio-Emulation™ Alpha

Smooth	CIBIOA
--------	--------



Bio-Emulation™ Beta

Smooth	CIBIOB
--------	--------



Bio-Emulation™ Delta

Smooth	CIBIOD
--------	--------



Bio-Emulation™ Epsilon

Smooth	CIBIOE
--------	--------



Bio-Emulation™ Gamma

Smooth	CIBIOY
--------	--------



Bio-Emulation™ Zeta

Smooth	CIBIOZ
--------	--------



Minimally Invasive Instruments

Minimally Invasive Instruments have exceptionally fine working ends, which aid the clinician when working under a magnifying glass or microscope. Designed for both minimally invasive and microscopic dental procedures, these instruments can be used with up to 25x magnification.



Learn more about our [Minimally Invasive Instruments](#).



#11 DE Explorer

0.2 mm

Thin Smooth

EXKOT11



Heidemann Spatula

Thin Smooth

PFIKOT2



Interproximal Carver

Thin Smooth

CVKOT1



Interproximal Carver, Off Angle
Thin Smooth **CVKOT2**

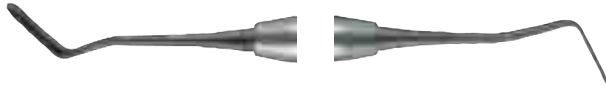

Interproximal Carver
Thin Smooth **CVIPCKOT4**

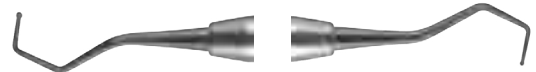

#1 DE Burnisher
0.5 - 0.8 mm
Thin Smooth **BBKOT1**

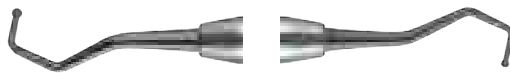

#2 DE Burnisher
1.0 - 1.3 mm
Thin Smooth **BBKOT2**

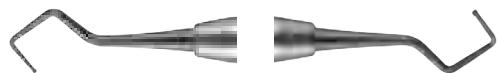

#3 DE Burnisher
0.5 - 0.8 mm
Thin Smooth **BBKOT3**

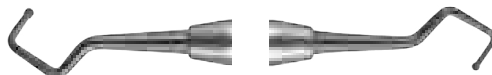

#4 DE Burnisher
1.0 - 1.3 mm
Thin Smooth **BBKOT4**



#5 DE Burnisher
0.6 mm
Thin Smooth **BBKOT5**



#6 DE Burnisher
0.8 mm
Thin Smooth **BBKOT6**



#11 DE Burnisher
0.4 mm
Thin Smooth **BBKOT11**



#12 DE Burnisher
0.6 mm
Thin Smooth **BBKOT12**



#13 DE Burnisher
0.8 mm
Thin Smooth **BBKOT13**



#14 DE Burnisher
1.0 mm
Thin Smooth **BBKOT14**

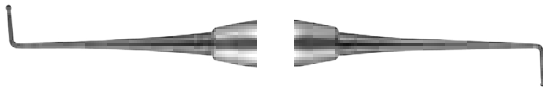

#26/27 DE Burnisher
0.5 - 0.8 mm
Thin Smooth **BBKOT26/27**

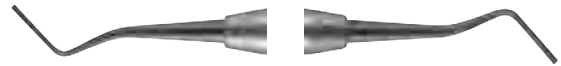

#1 DE Plugger, Non-Serrated
0.6 - 0.8 mm
Thin Smooth **PLGKOT1**

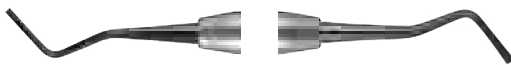

#2 DE Plugger, Non-Serrated
1.0 - 1.3 mm
Thin Smooth **PLGKOT2**

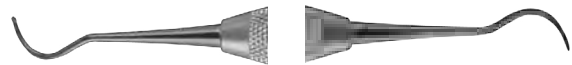

#1 DE Wiland Excavator
0.8 mm
Smooth **EXCKOT1**



#2 DE Wiland Excavator
1.0 mm
Smooth **EXCKOT2**

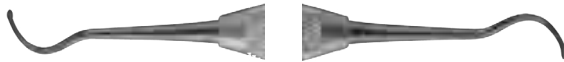

#3 DE Wiland Excavator
1.3 mm
Smooth **EXCKOT3**

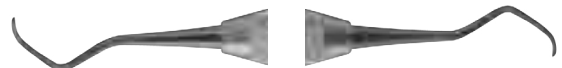

#4 DE Columbia Excavator
0.8 mm
Smooth **EXCKOT4**



#5 DE Columbia Excavator
1.0 mm
Smooth **EXCKOT5**

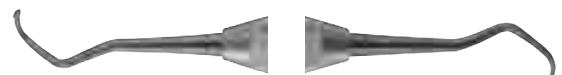

#6 DE Columbia Excavator
1.3 mm
Smooth **EXCKOT6**



Minimally Invasive Instruments

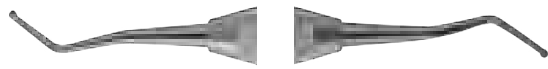

#61/62 DE Excavator, Straight

1.0 mm

Smooth

EXCKOT61/2

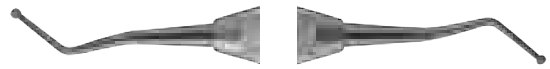

#63/64 DE Excavator, Straight

1.3 mm

Smooth

EXCKOT63/4

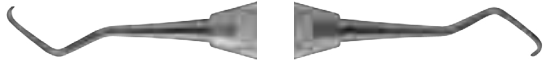

#13/14S DE Columbia Curette

Smooth

SC13/14SKO

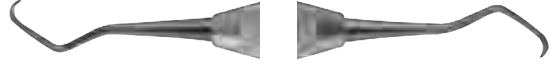

#13/14 DE Columbia Curette

Smooth

SC13/14KOT

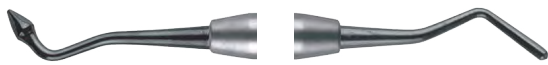

Minimally Invasive Contouring Instrument

Thin Smooth

PFIKOT1

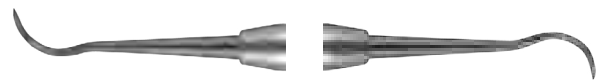

#8 DE Wiland Carver

Thin Smooth

CVWKOT8



Minimally Invasive Carver

Smooth

CVKOT3



Probe

Smooth

EPD6578XTS



Posterior Composite Instrument

Smooth

TNEXBKR1



Anterior Composite Instrument
Smooth **TNCVKR1**



Massironi 1.2 mm Spoon Chisel
Smooth **TNMASS1**



Massironi 1.5 mm Spoon Chisel
Smooth **TNMASS2**



Refer to [page A605](#) for a detailed listing of the [Massironi Kit for Prosthodontic Procedures \(MASSKITCASS\)](#)



Hatchets

Hatchets are restorative cutting instruments used for retentive areas, internal line angles, and for removing hard caries and unsupported enamel from cavity preparations.



Learn more about our [Hatchets](#).



8/9H Hatchet	
[10-7-14]	
#6	CP8/9H6
#7	CP54887
#8	CP8/9H8
#9	CP8/9H9
#41	CP8/9H



13/14 Hatchet	
[20-9-14]	
#41	CP13/14

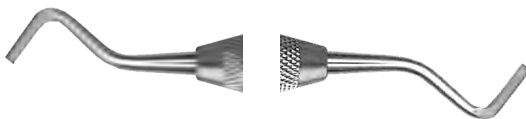

15/16 Hatchet	
[15-8-14]	
#6	CP15/166
#9	CP15/169
#41	CP15/16



17/18 Hatchet	
[10-6-14]	
#6	CP17/186
#9	CP17/189
#41	CP17/18



51/52 Hatchet
[15-8-12]
#41 **CP51/52**

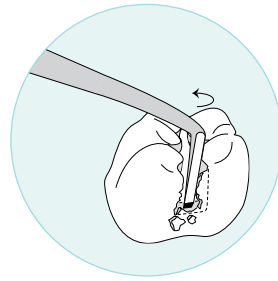

Hatchets
Used for cavity preparation:
retentive areas, internal line
angles and removing hard caries.



53/54 Hatchet
[10-6-12]
#6 **CP53/546**
#41 **CP53/54**



19 Bi-Bevel Hatchet
[3-2-28]
#41 **CP19**

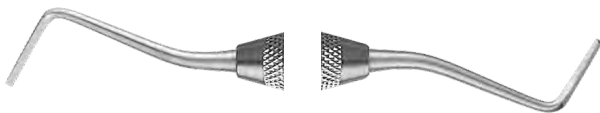

44S Off Angle Hatchet
#6 **CP44S6**
#9 **CP44S9**

....Suggested
Pair

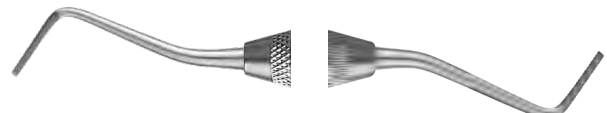

45S Off Angle Hatchet
#6 **CP45S6**
#9 **CP45S9**

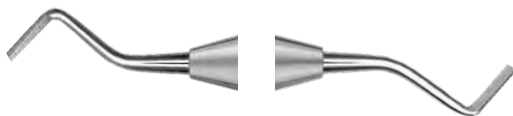

14/14 Off Angle Hatchet
[15-8-14]
#9 **CP14/149**
#41 **CP14/14**

....Suggested
Pair

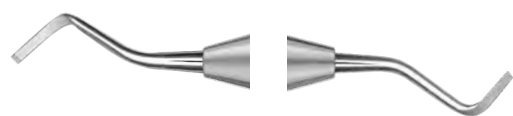

15/15 Off Angle Hatchet
[15-8-14]
#9 **CP15/159**
#41 **CP15/15**

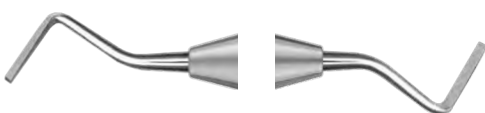

14/14-0 Off Angle Hatchet
[15-10-16]
#9 **CP14/14-09**
#41 **CP14/14-0**

....Suggested
Pair

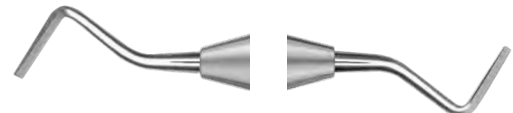

15/15-0 Off Angle Hatchet
[15-10-16]
#9 **CP15/15-09**
#41 **CP15/15-0**



Chisels

Chisels are imperative for cavity preparation. These instruments are used to remove, smooth, and contour areas of the bone.



Learn more about our [Chisels](#).



1/2 Wedelstaedt Chisel

[20-15-3]

#41

CP1/2



Atraumatal Restorative Chisel

#41

ART2



3/4 Wedelstaedt Chisel

[11.5-15-3]

#41

CP3/4



5/6 Wedelstaedt Chisel

[15-15-3]

#41

CP5/6



7/10 Straight Chisel

15-20

#41

CP7/10



8/9 Binangle Chisel

[20-9-8]

#41

CP8/9



11/12 Binangle Chisel

[15-8-8]

#41

CP11/12

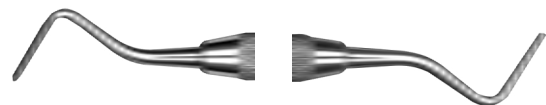

40/41 Binangle Chisel

[18-10-16]

#41

CP40/41

Hoes

Hoes are vital for cavity preparation. Similar to Chisels, but with additional capabilities of removing calculus and stain from surfaces.



Learn more about our [Hoes](#).



20 Hoe

[14-6-8]

#41

CP20



21 Hoe

[10-4-8]

#41

CP21

21 Double Ended Hoe

#41

CP21/21C



22

[10-4-14]

#41

CP22

22 Double Ended Hoe

#41

CP22/22C



23 Hoe

[6.5-2.5-9]

#41

CP23



24 Hoe

[8-3-25]

#41

CP24

24 Double Ended Hoe

#41

CP24/24C



Margin Trimmers

Margin Trimmers are a restorative cutting tool used to cut enamel and produce proper bevel on enamel margins. Similar to a hatchet except the blade is curved and the cutting edge angled.



Learn more about our [Margin Trimmers](#).



26 Distal Margin Trimmer	
[13-95-8-14]	
#41	MT26

Suggested Pair

26 Distal Heavy Margin Trimmer	
#41	MT26H
#6	MT26H6

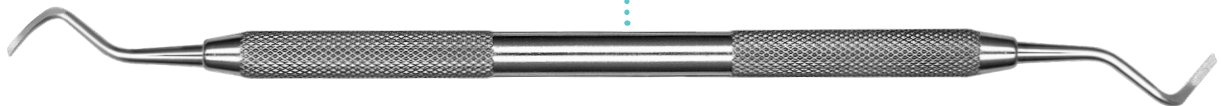

27 Mesial Margin Trimmer	
[13-80-8-14]	
#41	MT27

27 Mesial Heavy Margin Trimmer	
#41	MT27H
#6	MT27H6



28 Distal Margin Trimmer	
[10-95-7-14]	
#6	MT286
#7	MT54897
#9	MT289
#41	MT28

Suggested Pair

28 Distal Heavy	
#41	MT28H
#6	MT28H6



29 Mesial Margin Trimmer	
[10-80-7-14]	
#6	MT296
#7	MT54907
#9	MT299
#41	MT29

29 Mesial Heavy Margin Trimmer	
#41	MT29H
#6	MT29H6



DPT6 SE Darby Perry Trimmer
#41 **PFIDP6**

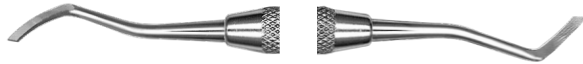

77/78 Distal Margin Trimmer
[15-95-8-12]
#41 **MT77/78**

77/78 Distal Heavy Margin Trimmer
#41 **MT77/78H**

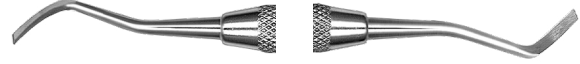

79/80 Mesial Margin Trimmer
[15-80-8-12]
#41 **MT79/80**

79/80 Mesial Heavy Margin Trimmer
#41 **MT79/80H**



232 Tru Bal Margin Trimmer
#9 **MT232TM9**



233 Tru Bal Margin Trimmer
#9 **MT233TM9**



232 Tucker Margin Trimmer
#9 **MT232TBM9**



233 Tucker Margin Trimmer
#9 **MT233TBM9**

• • • Refer to [page A607](#) for a detailed listing of the **Tucker 8 Kit (TUCKERKIT)**.



Angle Formers

Angle Formers are used for defining line angles, obtaining retentive form in dentin, and placing bevels on enamel margins.



Learn more about our [Angle Formers](#).



30/31 Angle Former

[12-80-5-8]

#41

CP30/31



32/33 Angle Former

[9-80-4-8]

#41

CP32/33



34/35 Angle Former

[7-80-2.5-9]

#41

CP34/35

Excavators

Excavators are used for removal of carious dentin.

 Learn more about our [Excavators](#).

Spoons



E1 Excavator
 1.2mm
 [12-9-15]
 #6 **EXCE16**
 #41 **EXCE1**



E2 Excavator
 1.5mm
 [15-9-15]
 #6 **EXCE26**
 #41 **EXCE2**



6 Excavator
 0.85mm
 #41 **EXC6**

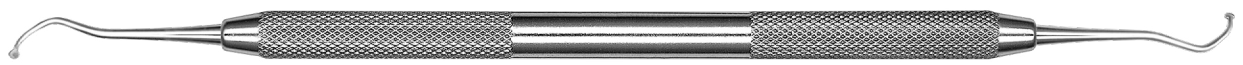

14 Excavator
 1.5mm
 #41 **EXC14**



17 Excavator

1.2mm

#6	EXC176
#7	EXC177
#8	EXC178
#9	EXC179
#41	EXC17

17 Heavy Excavator

1.2mm

#6	EXC17H6
#7	EXC17H7
#41	EXC17H



17W Heavy Excavator, Oval

1.2mm

#6	EXC17WH6
#41	EXC17WH

17W Excavator, Oval

1.2mm

#41	EXC17W
-----	------------------------



18 Excavator

1.5mm

#6	EXC186
#7	EXC187
#8	EXC188
#9	EXC189
#41	EXC18

18 Heavy Excavator

1.5mm

#6	EXC18H6
#41	EXC18H



18W Heavy Excavator, Oval

1.5mm

#6	EXC18WH6
#41	EXC18WH

18W Excavator, Oval

1.5mm

#41	EXC18W
-----	------------------------



19 Excavator

2.0mm

#41	EXC19
#6	EXC196
#7	EXC197
#8	EXC198

19 Heavy Excavator

2.0mm

#6	EXC19H6
#7	EXC19H7
#41	EXC19H

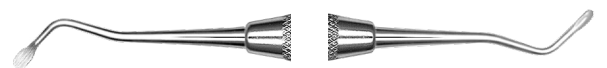
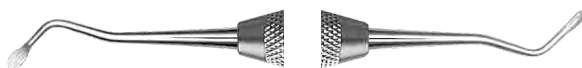

19W Heavy Excavator, Oval

2.0mm

#6	EXC19WH6
#41	EXC19WH

19W Excavator, Oval

1.8mm

#41	EXC19W
-----	------------------------



38/39 Excavator
 1.15mm [11.5-7-14]
 #6 [EXC38/396](#)
 #7 [EXC38/397](#)
 #41 [EXC38/39](#)



220/221 Darby-Perry Excavator, Oval
 1.5mm
 #6 [EXC220/16](#)
 #41 [EXC220/1](#)



36/37 Excavator
 1.5mm [15-8-14]
 #6 [EXC36/376](#)
 #41 [EXC36/37](#)



40/41 Excavator
 1.1mm [11-7-14]
 #41 [EXC40/41](#)



44/45 Excavator
 2.0mm [20-9-14]
 #6 [EXC44/456](#)
 #41 [EXC44/45](#)

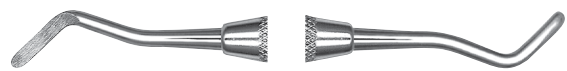

61/62 Excavator
 2.0mm [20-9-12]
 #41 [EXC61/62](#)

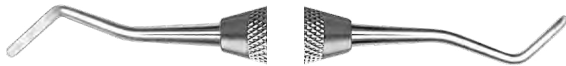

63/64 Excavator
 1.5mm [15-8-12]
 #6 [EXC63/646](#)
 #41 [EXC63/64](#)



65/66 Excavator
 1.0mm [10-6-12]
 #41 [EXC65/66](#)



English Patterns

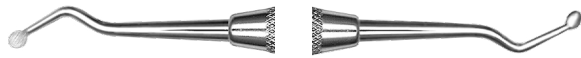

125/126 Excavator
 2.5mm
 #41 **EXC125/6**



127/128 Excavator
 2.0mm
 #41 **EXC127/8**

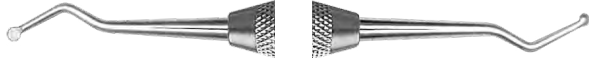

129/130 Excavator
 1.7mm
 #6 **EXC129/06**
 #41 **EXC129/0**



131/132 Excavator
 1.4mm
 #41 **EXC131/2**



153/154 Excavator
 1.0mm
 #6 **EXC153/46**
 #41 **EXC153/4**



Goldstein Interproximal Excavator
 1.2mm
 #9 **EXC2429**
 #41 **EXC242**



243 Excavator
 1.0mm
 #41 **EXC243**



244 Excavator
 1.4mm
 #41 **EXC244**



245 Excavator
 2.0mm
 #41 **EXC245**



246 Excavator
 0.8mm
 #6 **EXC2466**
 #9 **EXC2469**
 #41 **EXC246**

Placement Instruments

Placement Instruments are used to place base or liner within cavity preparations.



Learn more about our [Placement Instruments](#).

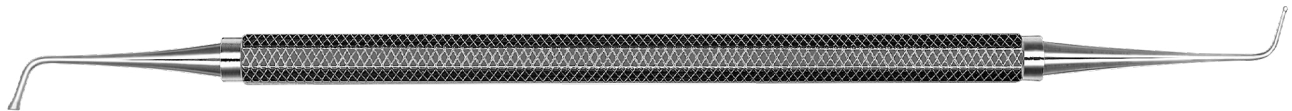

11 Novatech Placer
#2 **PINT11**



Goldstein Micro Placement Instrument
XTS **TNGMPI**

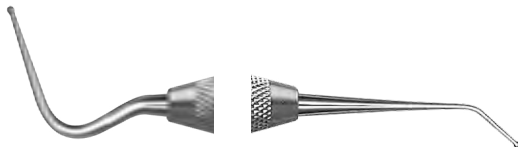

Calcium Hydroxide Placer
#6 **PICH6**
#8 **PICH8**
#41 **PICH**



313 Universal Mini Spatula/Placer
#6 **SP60616**
#41 **SP6061**

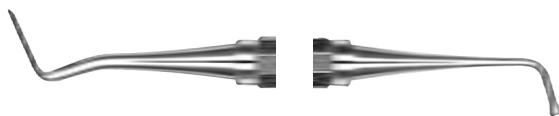

10 Novatech Placer
#2 **PINT10**



1 Composite Brush Handle
#41 **HCB1**



Pluggers & Condensers

Pluggers are used for packing, condensing and consolidating filling material into cavity preparations.



Learn more about our [Pluggers](#).



1/2 Andrew Plugger

#41	PLGA1/2
#8	PLGA1/28



1/2 Black Plugger

[15-7-12] [25-7-12]	
#6	PLG1/2NS6
#41	PLG1/2NS

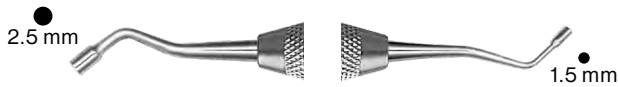

1/2 Serrated Plugger

#6	PLG1/26
#41	PLG1/2



H1 Hollenback Plugger

#6	PLGH16
#8	PLGH18
#41	PLGH1



H2 Hollenback Plugger
 #6 **PLGH26**
 #41 **PLGH2**

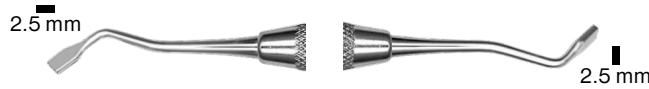

H3 Hollenback Plugger
 #41 **PLGH3**

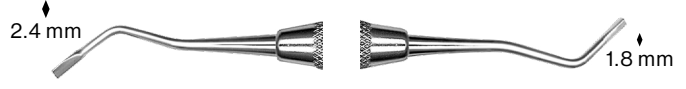

H4 Hollenback Plugger
 #41 **PLGH4**



O/1 Serrated Marquette Condenser
 #6 **PLG0/16**
 #41 **PLG0/1**

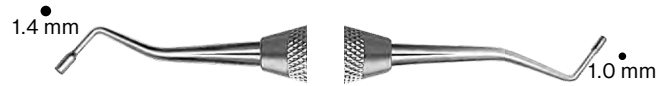

O/1 Non-Serrated Marquette Plugger
 #6 **PLG0/INS6**
 #41 **PLG0/INS**



2 Mortonson Plugger
 #41 **PLGMO2**

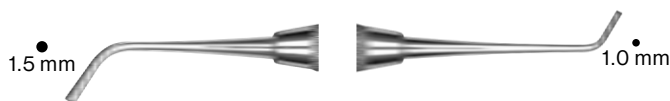

2 Serrated Smith Plugger
 #41 **PLGS2**

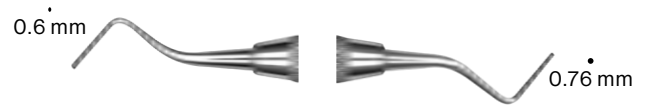

SPO Serrated Plugger
 #41 **PLGSP0**



1M Markley Plugger
 #2 **PLG1M**



Pluggers

Restorative



2M Markley Plugger
 #6 **PLG2M6**
 #2 **PLG2M**



4M Markley Plugger
 #2 **PLG4M**

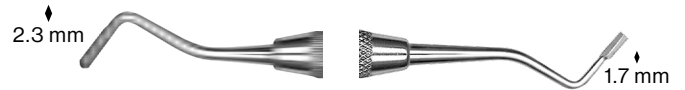

1T Tanner Plugger
 #41 **PLG1T**

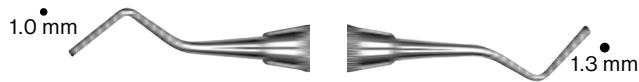

2T Tanner Plugger
 #41 **PLG2T**
 #6 **PLG5169**

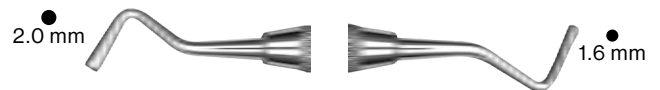

3T Tanner Plugger
 #41 **PLG3T**

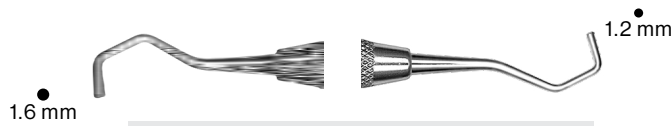

9/10 Back Action Plugger
 #41 **PLG9/10**

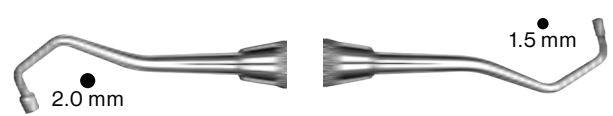

11/12 Back Action
 #41 **PLG11/12**

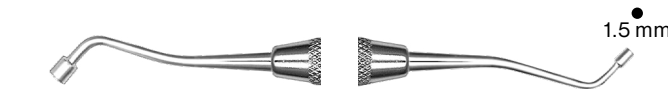

153 Serrated English Pattern
 #41 **PLG153**



154 Serrated English Pattern
 #41 **PLG154**

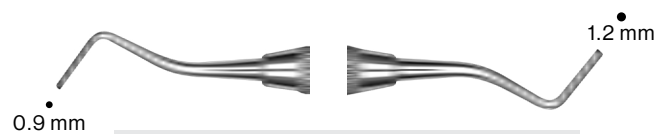

1 Oregon Plugger
 #41 **PLGOR1**
 #8 **PLGOR18**



2 Oregon Plugger
 #6 **PLGOR26**
 #41 **PLGOR2**



3 Oregon Plugger
#41 **PLGOR3**



4 Oregon Plugger
#41 **PLGOR4**



1 Ward Plugger
#41 **PLGW1**



2 Ward Plugger
#41 **PLGW2**

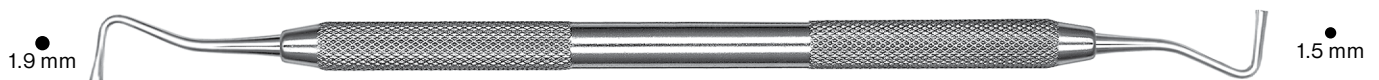

3 Ward Plugger
#41 **PLGW3**



Bone Plugger
#6, Short **PLG1SIM**



Amalgam Carriers & Files

Our Amalgam Carriers are used to carry and dispense amalgam filling materials. Amalgam Files are used for finishing gingival margins.



Learn more about our [Amalgam Carriers & Files](#).

Amalgam Carriers



Amalgam Carrier, Reg/Mini

AC601



Amalgam Carrier, Reg/Lg

AC602



Amalgam Carrier, Reg/Jumbo

AC603



Amalgam Well

WELL

Amalgam Files



1/4 Wedelstaedt Amalgam File

#41

AF1/4



31/32 Rhein Amalgam File

#41

AF31/32



Articulating Paper Forceps

Articulating Paper Forceps are instruments used for grasping and handling articulating paper.



Learn more about our [Articulating Paper Forceps](#).

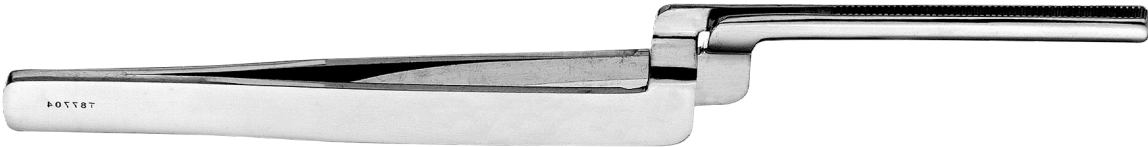

Miller Articulating Paper Forceps
APF2



Articulating & Occlusion Testing Materials

Testing Materials help identify every point of Articulation and Occlusion with a combination of film and paper. Clear, positive markings are guaranteed without smudging wet or dry fields because of our proprietary manufacturing process combined with stringent quality control.



Learn more about our [Articulating & Occlusion Testing Materials](#).

Articulating Paper

Articulating Paper

12 sheets/book - 12 books/box

Extra Thin .0015"/38 microns	Blue	TPXT
XX Thin .00125"/32 microns	Blue	TPXXT
Thick .005"/127 microns	Blue	TPTH
Thin .0028"/71 microns	Blue	TPT
Combo .0028"/71 microns	Blue/Red	TPBR

Articulating Paper

12 sheets/book - 6 books/box

Horseshoe .0035"/89 microns	Blue/Red	TPH
-----------------------------	----------	------------



Articulating Film

Articulating Film

25 sheets/book - 12 books/box .0005"/13 microns

Precisely True Thin	Blue	TPP
---------------------	------	------------



Carvers

Carvers are used to carve anatomical features, contour surfaces, and trim excess materials.



Learn more about our [Carvers](#).



8 Wiland Carver	
#6	CVWI86
#7	CVWI87
#41	CVWI8



Interproximal Carver <i>Class III, IV, and V Restorations</i>	
#6	CVIPC6
#7	CVIPC7
#8	CVIPC8
#41	CVIPC

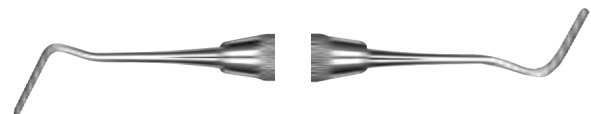

Interproximal Off Angle Carver	
#41	CVIPCOA



1/2 Hollenback Carver	
#9	CVHL1/29
#6	CVHL1/26
#7	CVHL1/27
#8	CVHL1/28
#41	CVHL1/2

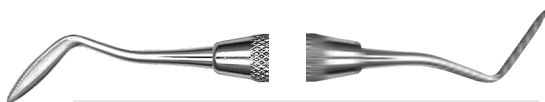

3 Hollenback Carver	
#41	CVHL3



3S Hollenback Carver	
#6	CVHL3S6
#7	CVHL3S7
#41	CVHL3S



3 Tanner Carver

#41

CV3T



4 Tanner Carver

#41

CV4T



5 Tanner Carver

#6

CV5T6

#41

CV5T

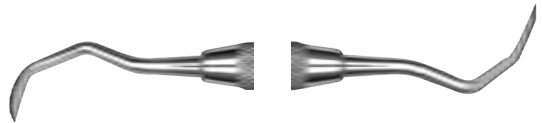

6 Tanner Carver

#41

CV6T



1 Wall Carver

#41

CVWL1



3 Wall Carver

#41

CVWL3

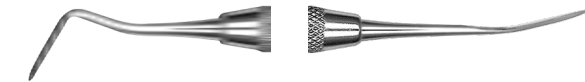

1 Ward Carver

#41

CVWR1

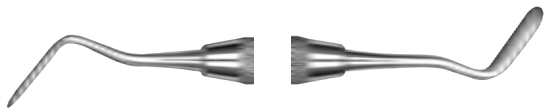

2 Ward Carver

#41

CVWR2



1 Andrew Carver

#41

CVA1



2 Andrew Carver

#41

CVA2



3 Andrew Carver

#41

CVA3



4 Clappison Carver

#41

CVCL4



2/3 Frahm Carver
 #6 **CVFR2/36**
 #41 **CVFR2/3**



104 Carver
 #41 **CV104**



1 Hollenback Carver 2 Modified Cleoid Small
 #41 **CVH1/MC2**



1 Hollenback Carver 3 Modified Cleoid Large
 #41 **CVH1/MC3**



1 Hollenback Carver
 #41 **CVH1**



2 Hollenback Carver
 #41 **CVHL2**

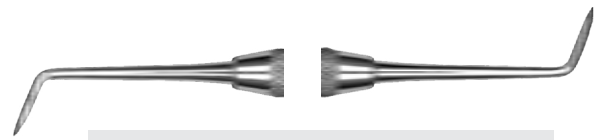

L7 Levy Carver
 #41 **CVL7**



SHO-A Shoshan Carver
 #41 **CVSA**



18 Sprengel Carver
 #6 **CVSPR186**
 #41 **CVSPR18**

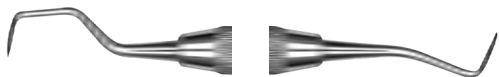

1 Tharp Carver
 #41 **CVTH1**



2 Tharp Carver
 #41 **CVTH2**

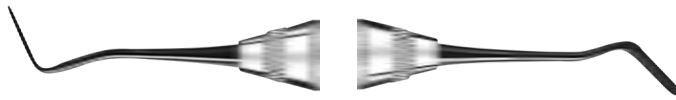

Interproximal Carver <i>Class III, IV, and V Restorations</i>	
XTS	TNCVIPC
#41	CVIPC
#6	CVIPC6
#7	CVIPC7
#8	CVIPC8



Interproximal Carver, Long	
XTS	TNCVIPCL

Discoid-Cleoids



1/2 Carver	
#41	CD1/2

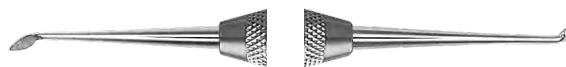

4/5 Carver	
#6	CD4/56
#7	CD4/57

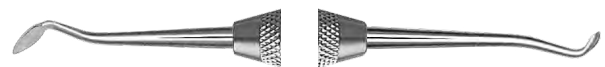

3/6 Carver	
#6	CD3/66
#7	CD3/67
#8	CD3/68
#41	CD3/6

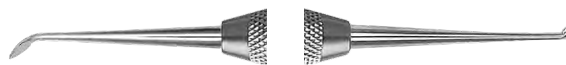

89/92 Carver	
#6	CD89/926
#7	CD89/927
#8	CD89/928



90B Carver	
#41	CD90B



W-A-C-D Carver	
#41	CDWACD



Anatomical Tungsten Carbide Carver	
#41	CVTCA/B



Discoid-Cleoid Tungsten Carbide Carver	
#41	CVTCC/D

CLEOID
Spade shape
with point for carving
occlusal anatomy

DISCOID
Round shape
for removing
excess material



E Tungsten Carbide Knife	
#41	CVTCE

Knives

Knives and Cement Removers help trim excess filling material, flash, and overhang.



Learn more about our [Knives](#).



20 Esthetic Cement Remover

#6	CR206
#41	CR20



21 Esthetic Cement Remover

#6	CR216
#41	CR21



Edentulous Ridge Chisel (#36 Gold Foil Knife)

#41	GF36
-----	----------------------

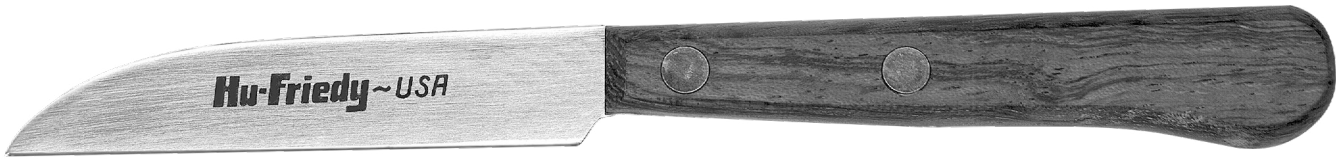

5A Knife

OK5A



12 Novatech Cement Remover

#41

CRNT12



2S Amalgam Knife

#41

GK2S



7 Black Amalgam Knife

#41

GK7



14L Amalgam Knife

#41

GK14L



29 Amalgam Knife

#41

GK29

Burnishers

Burnishers are used for contouring composite fillings.



Learn more about our [Burnishers](#).



18 Burnisher
 #6 **BB186**
 #41 **BB18**



26/27S Burnisher
 #6 **BB26/27S6**
 #41 **BB26/27S**



27/29 Burnisher
 #6 **BB27/296**
 #7 **BB27/297**
 #8 **BB27/298**
 #41 **BB27/29**



2 Burnisher
 2.6mm
 #41 **BB2SE**



2 Burnisher DE
 2.6mm/1.5mm
 #41 **BB2DE**



2/29 Burnisher
 2.6mm/3.1mm
 #41 **BB2/29**



27/29 Burnisher
 XTS **TNBB27/29**

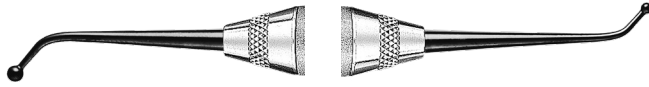

Medium/Large Ball Burnisher
XTS **TNBB18**

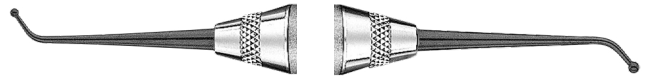

Small/Medium Ball Burnisher
XTS **TNBS/M**

Acorn



21 Cone Burnisher
2.7mm/1.7mm
#6 **BB216**
#41 **BB21**

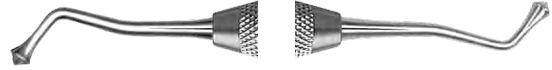

21B Cone Burnisher
3.0mm/2.7mm
#6 **BB21B6**
#8 **BB21B8**
#41 **BB21B**

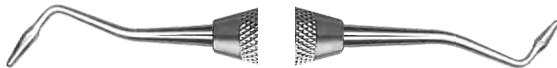

PKT-3R Rounded Cone Burnisher
#6 **PKT3R6**
#41 **PKT3R**

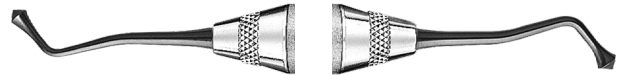

21B Cone Burnisher
XTS **TNBB21B**



Romerowski Burnisher
#41 **BBROM**

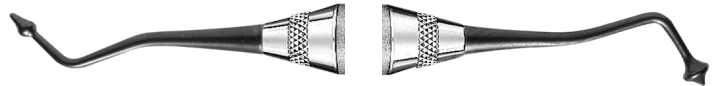

Freedman Duckhead Burnisher
XTS **TNPCCI**

Ladmore



2 Ladmore Burnisher
1.9mm/1.3mm
#41 **BBL2**



3 Ladmore Burnisher
1.9mm/1.3mm
#6 **BBL36**
#41 **BBL3**

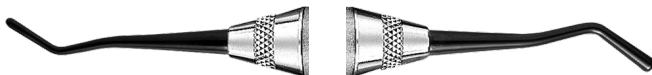

2 Ladmore Burnisher
XTS **TNBBL2**

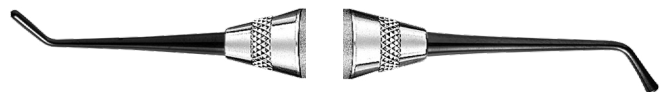

3 Ladmore Burnisher
XTS **TNBBL3**

Matrix Strips

Matrix strips are used to isolate teeth. The material is made of Mylar polyester film, allowing the strips to resist solvents so they will not stretch, curl, or break.



Learn more about our [Matrix Strips](#).



Matrix Strips
 4"/10 cmL x 0.375"/.95 cm
 500/tube ; 9/cs **KSTRIP500**

Matrix Strips
 0.002"/60microns
 1,000/tube ; 4/cs **KSTRIP1000**



Gingival Retractors

Gingival Retractors protect tissue during cavity preparation. The concave shape of the tips conform to root surfaces and gingival tissue.



Learn more about our [Gingival Retractors](#).



Kincheloe Gingival Retractor

#41

GRK1



1 Meinershagen Gingival Retractor

#41

GRM1



2 Meinershagen Gingival Retractor

#41

GRM2

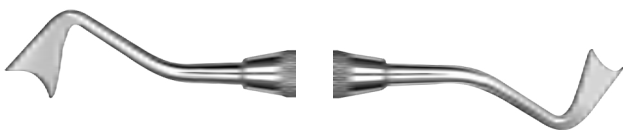

3 Meinershagen Gingival Retractor

#41

GRM3

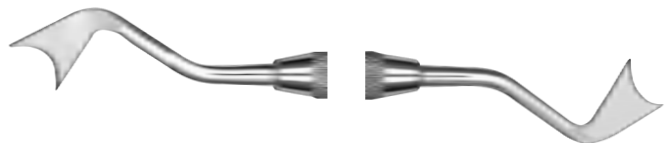

4 Meinershagen Gingival Retractor

#41

GRM4

Gingival Cord Packers

Gingival Cord Packers are used to pack retraction cord into the sulcus. The cord packers with round, non-serrated working ends are used for atraumatic cord placement; serrated cord packers should only be used with braided cord.



Learn more about our [Gingival Cord Packers](#).



BN1 Gingival Cord Packer
#41 [GCPBN1](#)



CSI-1 Gingival Cord Packer, Non-Serrated
#41 [GPCSI1NS](#)

CSI-1 Gingival Cord Packer, Serrated
#6 [GPCSI16](#)
#41 [GPCSI1](#)



113 Gingival Cord Packer, Non-Serrated
#41 [GCP113NS](#)

113 Gingival Cord Packer, Serrated
#6 [GCP1136](#)
#41 [GCP113](#)



7 Guyer Gingival Cord Packer, Non-Serrated
#6 [GCPG7NS6](#)
#41 [GCPG7NS](#)

7 Guyer Gingival Cord Packer, Serrated
#6 [GCPG76](#)
#41 [GCPG7](#)



Gingival Cord Packers



S6 Gingival Cord Packer

#6	GCP66
#41	GCP6



S6 (GCP6) accurate cord placement with minimal tissue trauma.

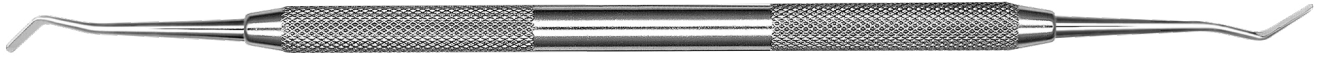

Balshi Gingival Cord Packer

#41	GCPBAL
-----	---------------

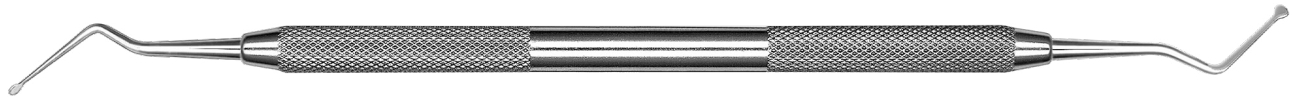

1 Yardley Gingival Cord Packer

#6	GCPYD16
#41	GCPYD1

Crowns

Stainless Steel Pedo and Permanent Crowns are pre-trimmed and crimped, for quick and simple placement. Accurate occlusal anatomy that mimics the natural tooth. Ideal occlusal thickness, offering superior resilience to abrasion and perforation.



Learn more about our **Pedo and Permanent Stainless Steel Molar Crowns.**

Primary Crowns

Stainless Steel Pedo Crowns come in 48 sizes for use on the first and second primary molars. These crowns feature a more narrow mesial-distal maxillary first primary molar width for quicker adjacent crown placement.



Introductory Kit

Contains 48 Crowns (1 of each size)

SSC-KIT



Empty Pedo Crowns Intro Kit (No Crowns)

For organization (no crowns included)

SSC-TRAY



Primary Crown Refill Boxes

QTY: 5/box

Upper Right Primary 1st #2	SSC-URD2	Lower Right Primary 1st #2	SSC-LRD2
Upper Right Primary 1st #3	SSC-URD3	Lower Right Primary 1st #3	SSC-LRD3
Upper Right Primary 1st #4	SSC-URD4	Lower Right Primary 1st #4	SSC-LRD4
Upper Right Primary 1st #5	SSC-URD5	Lower Right Primary 1st #5	SSC-LRD5
Upper Right Primary 1st #6	SSC-URD6	Lower Right Primary 1st #6	SSC-LRD6
Upper Right Primary 1st #7	SSC-URD7	Lower Right Primary 1st #7	SSC-LRD7
Upper Right Primary 2nd #2	SSC-URE2	Lower Right Primary 2nd #2	SSC-LRE2
Upper Right Primary 2nd #3	SSC-URE3	Lower Right Primary 2nd #3	SSC-LRE3
Upper Right Primary 2nd #4	SSC-URE4	Lower Right Primary 2nd #4	SSC-LRE4
Upper Right Primary 2nd #5	SSC-URE5	Lower Right Primary 2nd #5	SSC-LRE5
Upper Right Primary 2nd #6	SSC-URE6	Lower Right Primary 2nd #6	SSC-LRE6
Upper Right Primary 2nd #7	SSC-URE7	Lower Right Primary 2nd #7	SSC-LRE7
Upper Left Primary 1st #2	SSC-ULD2	Lower Left Primary 1st #2	SSC-LLD2
Upper Left Primary 1st #3	SSC-ULD3	Lower Left Primary 1st #3	SSC-LLD3
Upper Left Primary 1st #4	SSC-ULD4	Lower Left Primary 1st #4	SSC-LLD4
Upper Left Primary 1st #5	SSC-ULD5	Lower Left Primary 1st #5	SSC-LLD5
Upper Left Primary 1st #6	SSC-ULD6	Lower Left Primary 1st #6	SSC-LLD6
Upper Left Primary 1st #7	SSC-ULD7	Lower Left Primary 1st #7	SSC-LLD7
Upper Left Primary 2nd #2	SSC-ULE2	Lower Left Primary 2nd #2	SSC-LLE2
Upper Left Primary 2nd #3	SSC-ULE3	Lower Left Primary 2nd #3	SSC-LLE3
Upper Left Primary 2nd #4	SSC-ULE4	Lower Left Primary 2nd #4	SSC-LLE4
Upper Left Primary 2nd #5	SSC-ULE5	Lower Left Primary 2nd #5	SSC-LLE5
Upper Left Primary 2nd #6	SSC-ULE6	Lower Left Primary 2nd #6	SSC-LLE6
Upper Left Primary 2nd #7	SSC-ULE7	Lower Left Primary 2nd #7	SSC-LLE7

Permanent Crowns

Stainless Steel Permanent Molar Crowns come in 24 sizes and are intended to fill the need for long term provisional coverage on first permanent molars.



Permanent SSC Introductory Kit

Contains 24 Crowns (1 of each size)

SSC-PKIT



Permanent SSC Empty Tray

For organization (no crowns included)

SSC-PTRAY



Permanent SSC Master Kit

Contains 96 Crowns (4 of each size)

SSC-PKITM

Permanent Crown Refill Boxes

QTY: 5/box

Upper Right Permanent #2	SSC-6UR2
Upper Right Permanent #3	SSC-6UR3
Upper Right Permanent #4	SSC-6UR4
Upper Right Permanent #5	SSC-6UR5
Upper Right Permanent #6	SSC-6UR6
Upper Right Permanent #7	SSC-6UR7
Upper Left Permanent #2	SSC-6UL2
Upper Left Permanent #3	SSC-6UL3
Upper Left Permanent #4	SSC-6UL4
Upper Left Permanent #5	SSC-6UL5
Upper Left Permanent #6	SSC-6UL6
Upper Left Permanent #7	SSC-6UL7

Lower Right Permanent #2	SSC-6LR2
Lower Right Permanent #3	SSC-6LR3
Lower Right Permanent #4	SSC-6LR4
Lower Right Permanent #5	SSC-6LR5
Lower Right Permanent #6	SSC-6LR6
Lower Right Permanent #7	SSC-6LR7
Lower Left Permanent #2	SSC-6LL2
Lower Left Permanent #3	SSC-6LL3
Lower Left Permanent #4	SSC-6LL4
Lower Left Permanent #5	SSC-6LL5
Lower Left Permanent #6	SSC-6LL6
Lower Left Permanent #7	SSC-6LL7

Stainless Steel Molar Crowns



Experience the Perfect Fit for All Patients

No matter what patient walks through your door, HuFriedyGroup now has you covered more than ever before. **Our line of Stainless Steel Crowns has expanded to include Permanent Molar Crowns!** All of our Stainless Steel Crowns deliver all the features and benefits of our Pedo Crowns that you love, but now in the form of Permanent Crowns as well.

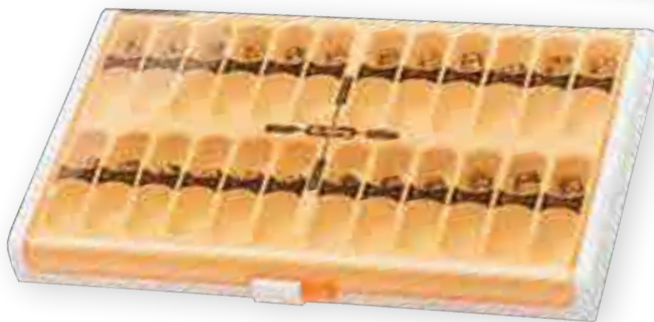

POINTS OF PERFORMANCE

These stainless steel primary and permanent molar crowns were developed to deliver consistent, accurate and predictable clinical outcomes, while allowing the practitioner to work more effectively and efficiently, ensuring more time for value-added services such as patient education and treatment planning.

- More narrow mesial-distal maxillary first primary molar width for quicker adjacent crown placement
- Ideal wall height meaning less trimming and crimping (if at all!)
- Pre-trimmed, crimped and contoured surfaces for less time spent chairside
- Accurate occlusal anatomy mimicking the natural tooth
- Optimal occlusal thickness with superior resilience to abrasion and perforation



Visit us online at [HuFriedyGroup.com/Crowns](https://www.hufriedygroup.com/Crowns)

Crown Removers

Permanent crown removers are used to break the seal between the tooth and crown during removal.



Learn more about our [Crown Removers](#).

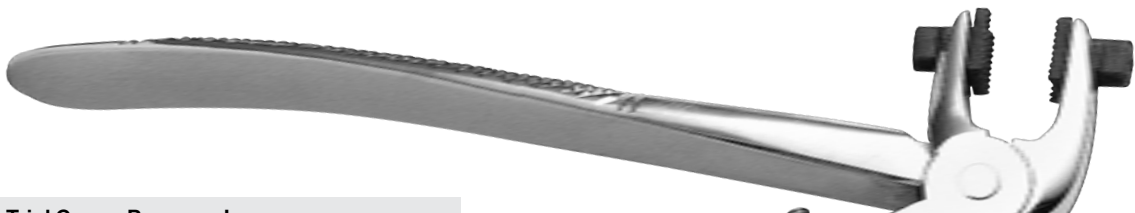

Trial Crown Remover Lower
[CRL](#)



Trial Crown Remover
[CRU](#)

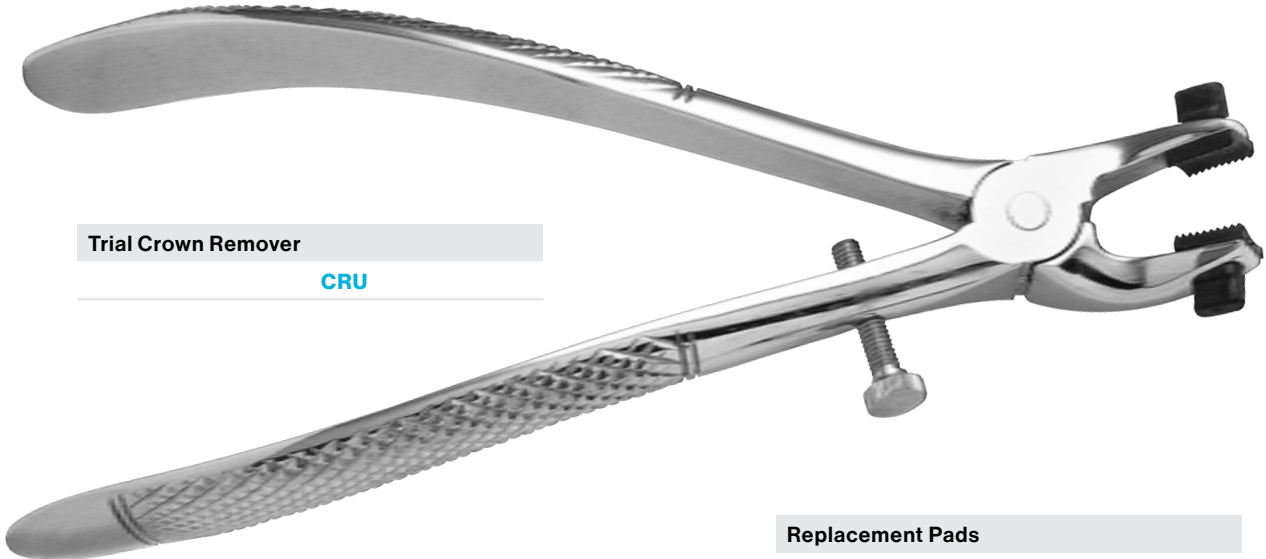

Replacement Pads
QTY: 2 [CRRP](#)

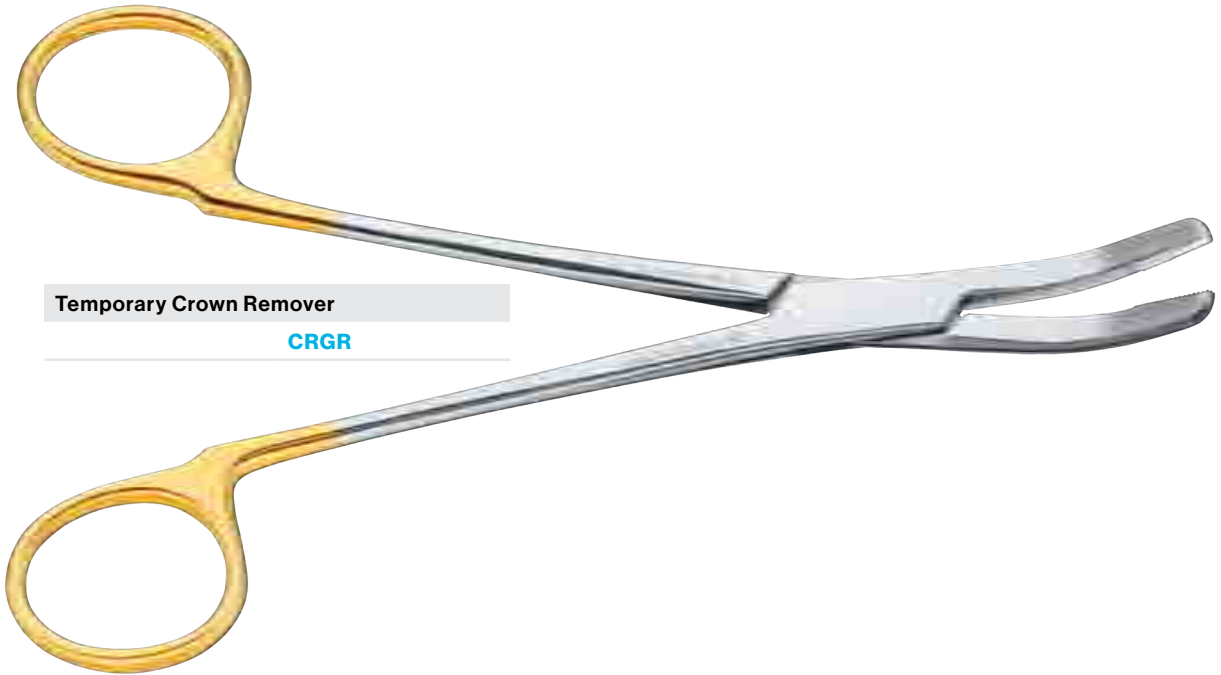

Temporary Crown Remover

CRGR

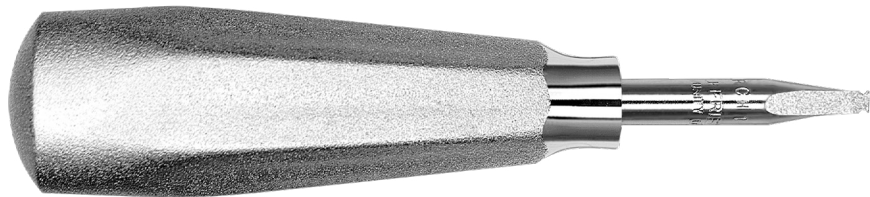

Christensen Crown Remover Straight, Anterior

CRCH1

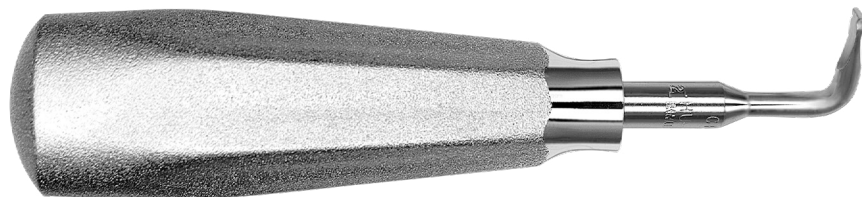

Christensen Crown Remover Right Angle, Posterior

CRCH2



Goldstein Crown Remover, Straight

GCRO



Goldstein Crown Remover, 45° Angle

GCR45



Goldstein Crown Remover, Occlusal

GCROS



Goldstein Crown Remover, Right Angle

GCR90



Esthetic Instruments

Designed for accurate esthetic measurements.



Learn more about our [Esthetic Instruments](#).



Nash/Taylor Crown Spreader
#6 **CRSPR**



Nash/Taylor Curved Veneer Stabilizer
#6 **VENSTAB**



Nash/Taylor Straight Veneer Stabilizer
#6 **VENSTABS**



Nash/Taylor Inlay/Onlay Instrument
#6 **IL/OL**



Nash/Taylor Interproximal Scaler
#6 **NTIPC**



Nash/Taylor Interproximal Knife
#6 **NTIPK**



Nash/Taylor Replacement Hammer
CRH



Nash/Taylor Replacement Shaft
CRS



Nash/Taylor Replacement Tip
CRTC



Nash/Taylor Temporary Veneer Remover
NASTACR

• • • Refer to [page A607](#) for a detailed listing of the [Nash Taylor Esthetic Instrument Kit \(NTEIK\)](#).



Spatulas

Spatulas are used for mixing materials and general laboratory use.



Learn more about our [Spatulas](#).



24 Flexible Spatula

1-3/4" (44 mm)

#6 **CS246**

#40 **CS24**

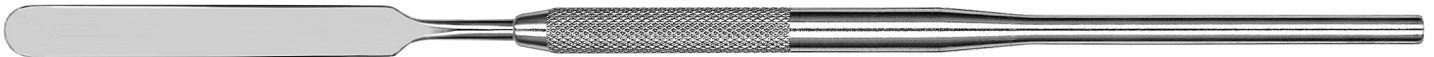

324 Rigid Spatula

2" (51 mm)

#40 **CS324**



A6 Rigid Spatula

1" (25mm)

#40 **CSA6**

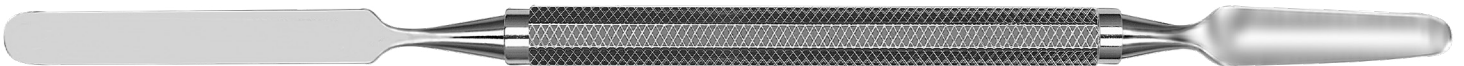

5 Novatech Long/Fluted Spatula

1.95" (50mm)

CSNT5



6 Novatech Long/Blade Spatula
1.95" (50mm) **CSNT6**



7 Novatech Short/Blade Spatula
1.38" (35mm) **CSNT7**



8 Novatech Long Spatula
1.95" (50mm) **CSNT8**



9 Novatech Short Spatula
1.38" (35mm) **CSNT9**



7 Wax Spatula
WS7



Waxing Spoon and Spatula
LWSS



Spatulas



#1 Heidmann Spatula

#41

PFIHS16



#2 Heidmann Spatula

#6

PFIHS26



#31 Wax Spatula

SPT31



7 Tapered Spatula

LS7

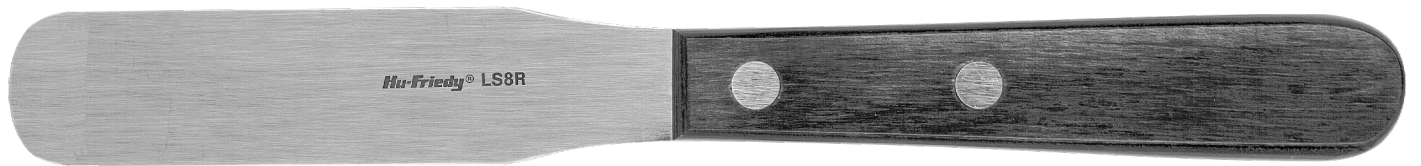

8R Rigid Spatula

LS8R

Mixing Pads

Mixing Pads are used for mixing cements, composites, rubber base materials and silicates. The pads have a non-skid base, and are available in three sizes.



Learn more about our [Mixing Pads](#).



Poly Coated Mixing Pads		
100 sheets/pad		
3"x3"	6 pads/1 pkg	KPAD33
3"x6"	6 pads/1 pkg	KPAD36
6"x6"	6 pads/1 pkg	KPAD66



Measuring Devices

Measuring Devices include calipers, gauges, and rulers that are used to obtain precise measurements.



Learn more about our [Measuring Devices](#).

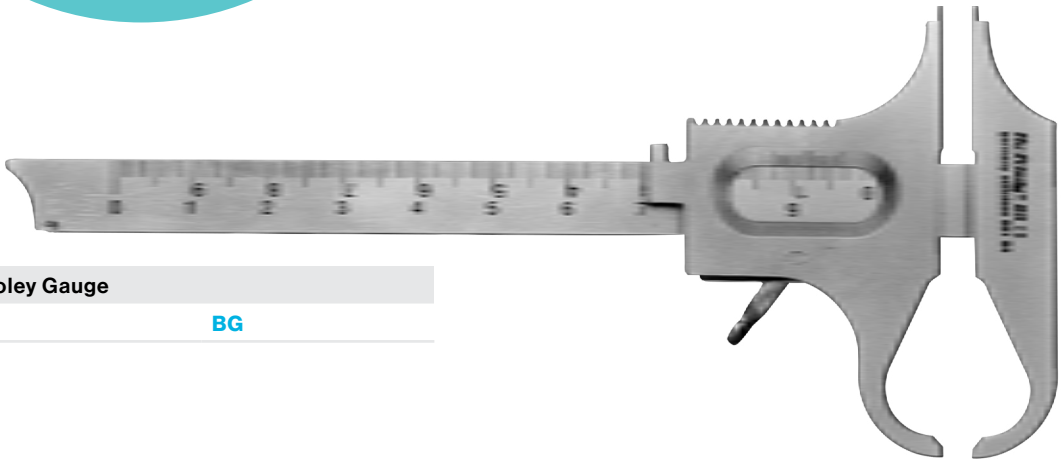

Boley Gauge
BG

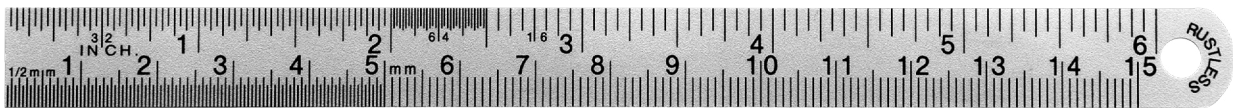

Stainless Steel Ruler
CLR6



1 Iwanson Spring Caliper - Metal and Porcelain
CLP1



2 Iwanson Spring Caliper - For Wax
CLP2



Proportion Gauge
1 Handle, 2 T-Bar Tips, 2 Inline Tips
XTS **PROGS**

Proportion Gauge
1 Handle, 2 T-Bar Tips, 2 Inline Tips
#8 **PROG**



Crown Lengthening Gauge
1 Handle, 2 BLPG Tips, 2 Papilla Tips
XTS **CLGS**

Crown Lengthening Gauge
1 Handle, 2 BLPG Tips, 2 Papilla Tips
#8 **CLG**



Sounding Gauge
XTS **SOUNDGS**

Sounding Gauge
#8 **SOUNDG**

• Refer to [page A606](#) for a detailed listing of **Chu's Aesthetic Gauges™ Set, Satin Steel (SCHUSET)** and **Chu's Aesthetic Gauges™ Set, Resin Handle (CHUSET)**.

Proportion and Crown Lengthening Gauge
#6 **PROCLHDL**

Proportion and Crown Lengthening Gauge
#8 **PROCLHDL**

T-Bar Replacement Tips
QTY: 3 **TBARREF**

Inline Replacement Tips
QTY: 3 **INLINEREF**

BLPG Replacement Tips
QTY: 3 **BLPGREF**

Papilla Replacement Tips (3 Tips)
QTY: 3 **PAPREF**



Waxing Instruments

Waxing Instruments are used for waxing procedures and techniques.



Learn more about our [Waxing Instruments](#).

P.K. Thomas

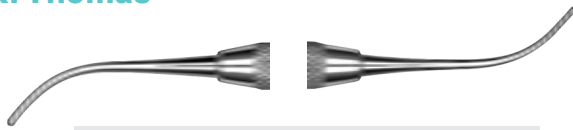

PKT-1 Waxing Instrument
#41 [PKT1](#)

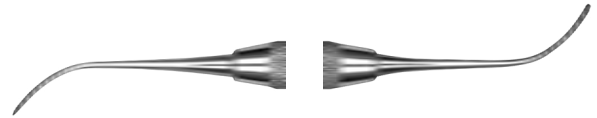

PKT-2 Waxing Instrument
#41 [PKT2](#)



PKT-3 Waxing Instrument
6 [PKT36](#)
#41 [PKT3](#)



PKT-3R Rounded Cone Waxing Instrument
#41 [PKT3R](#)

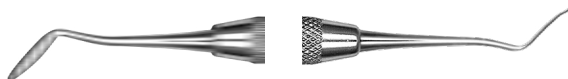

PKT-4 Waxing Instrument
#41 [PKT4](#)



PKT-5 Waxing Instrument
#41 [PKT5](#)



Shaw

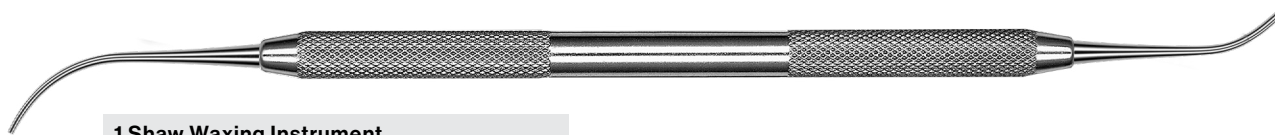

1 Shaw Waxing Instrument
#41 **SHAW1**

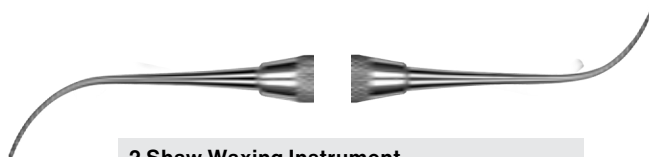

2 Shaw Waxing Instrument
#41 **SHAW2**



3 Shaw Carver
#41 **SHAW3**



4 Shaw Burnisher
#41 **SHAW4**

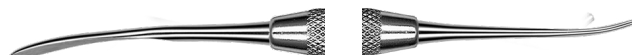

7 Shaw Spatula
#41 **SHAW7**

Wax Carvers



5 LeCron Wax Carver
#6 **CVLC56**
#41 **CVLC5**



Roach Wax Carver
#41 **CVROA**



Vehe Wax Carver
#41 **CVVH**



Learn more about our [Wax Carvers.](#)

Surgical Black Line	A702	Mouth Props	A787
Handles	A704	Needle Holders	A787
Collections & Kits	A706	Osteotomes	A794
Aspirators	A720	Periosteals	A797
Calipers	A722	Periotomes	A806
Chisels	A723	Retractors	A807
Surgical Curettes	A728	Rongeurs	A812
Elevators	A733	Root Tip Picks	A815
Bone Files	A746	Scalpel Blades & Handles	A820
Periodontal Files	A748	Blades & Blade Handles	A824
Forceps	A749	Scissors	A827
Gauze Packers	A770	Sutures	A835
Grafting Instruments	A771	Syringes	A838
Hemostats	A774	Tissue Pliers	A839
Implantology	A776	Tissue Nippers	A848
Knives	A782	Towel Clamps	A849
Mallets	A786	Wire Products	A850
Mouth Gags	A786	Wire Twisters & Scissors	A851

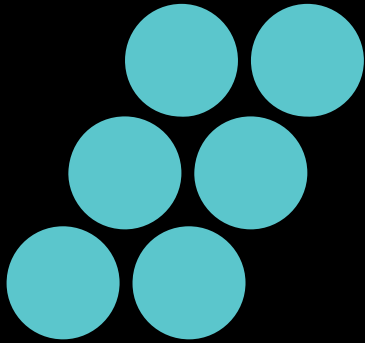

Surgical

Our extensive line of Surgical Instruments, many designed in conjunction with Key Opinion Leaders, provide the absolute precision and performance required in dental surgery. By combining handcrafted artistry, innovative technology, utilizing proprietary materials and processes and through extensive quality controls, our instruments are crafted to the highest quality standard, enabling clinicians to deliver the best possible outcome for their patients every time and be **The Best in Practice.**



Surgical Black Line

Designed for performance, the HuFriedyGroup Black Line is engineered with Aluminum Titanium Nitride to optimize clinical outcomes by delivering efficiency throughout the entire surgical procedure. From reducing light reflection to enhancing visibility at the surgical site, the Black Line was designed with the clinician in mind. In addition to the surgical hand instrument portfolio, the Black Line now includes 7 Super-Cut scissor designs delivering superior performance through enhanced precision and innovation.

Unique, smooth, large diameter lightweight handle for **maximum comfort, reduced hand fatigue and increased control**

Black Line Surgical Hand Instruments

Performance engineered coating for a harder, smoother surface for **optimal edge retention and enhanced lubricity**

Reduced light reflection afforded by a matte finished handle and black working ends

Handcrafted with Immunity Steel® Alloy for **optimal strength and corrosion resistance**

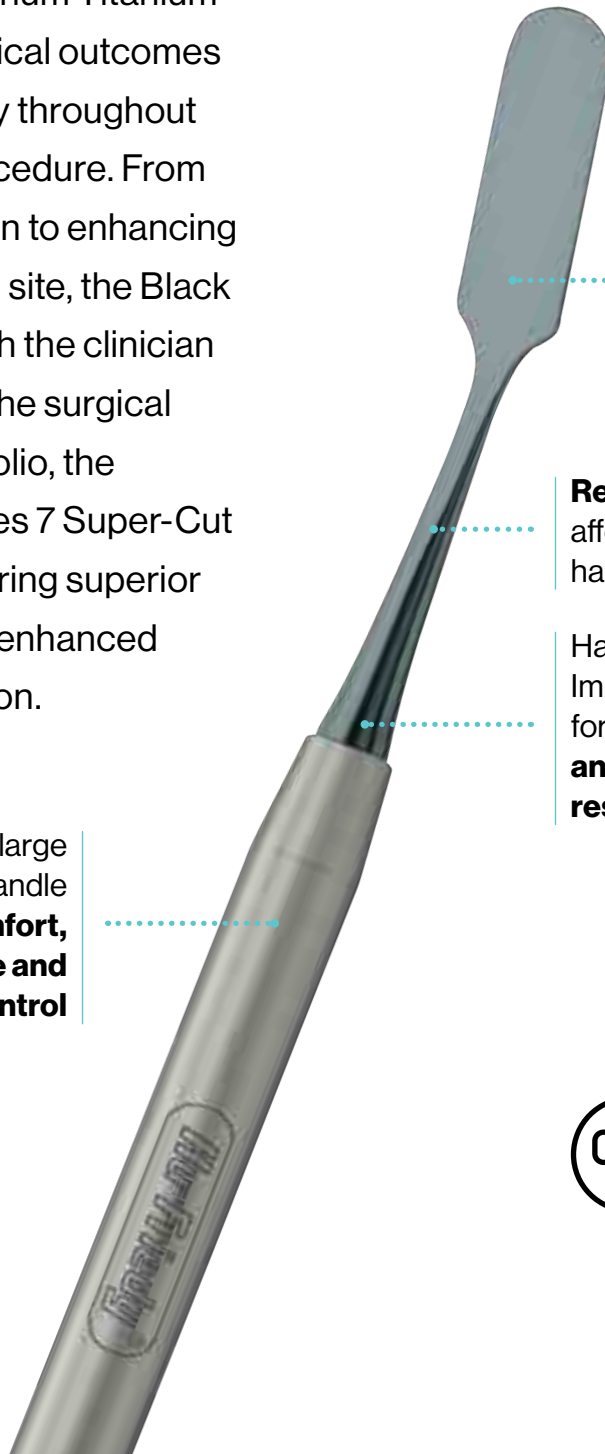

Learn more about our entire **Black Line Collection**.

Black Line Scissors

Performance engineered coating for **optimal edge retention**

Gold screw for easy identification of **Super-Cut design**

Reduced light reflection afforded by a matte black finish

Super-Cut design featuring a **razor sharp blade and serrated edge for reduced tissue slippage**

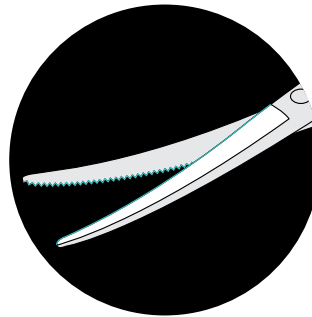

Distinct black finish for **enriched contrast and visual acuity at the surgical site and underlying tissue**

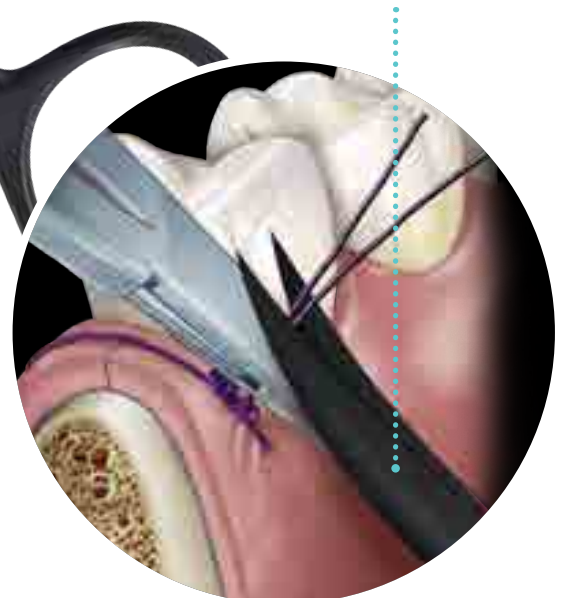



Handles

With finely crafted handle options, you can select various styles, sizes, textures, and materials that suit your needs. Our handles are engineered to stringent standards for optimal balance, comfort, and precision.

#2



#2 short



#6



#6 short



#9



#10



#502



#510

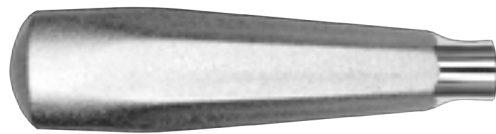

#522



#524



Black Line



Black Line Short





Collections & Kits



We offer a wide variety of pre-assembled Surgical Kits & Collections for any Surgical procedure. Whether curated by HuFriedyGroup or by one of our world-renowned Key Opinion Leaders, our Kits and Collections are the perfect assembly of products for any dental surgeon.

Luxating Hybrid Elevator Kit, Black Line	EPTKITX
Infinity 8 Instrument Cassette, Gray	IMN5081
Luxating Hybrid Elevator, Straight Spade, Black Line	EPTSSPX
Luxating Hybrid Elevator, Small Straight, Black Line	EPTSMSX
Luxating Hybrid Elevator, Small Curved, Black Line	EPTSMCX
Luxating Hybrid Elevator, Small Distal, Black Line	EPTSMDX
Luxating Hybrid Elevator, Small Mesial, Black Line	EPTSMMX
Luxating Hybrid Elevator, Large Distal, Black Line	EPTLGDX
Luxating Hybrid Elevator, Large Mesial, Black Line	EPTLGMX
Luxating Hybrid Elevator Kit	EPTKIT
Infinity 8 Instrument Cassette, Red	IMN5080
Luxating Hybrid Elevator, Straight Spade, #6 Handle	EPTSSP
Luxating Hybrid Elevator, Small Straight, #6 Handle	EPTSMS
Luxating Hybrid Elevator, Small Curved, #6 Handle	EPTSMC
Luxating Hybrid Elevator, Small Distal, #6 Handle	EPTSMD
Luxating Hybrid Elevator, Small Mesial, #6 Handle	EPTSMM
Luxating Hybrid Elevator, Large Distal, #6 Handle	EPTLGD
Luxating Hybrid Elevator, Large Mesial, #6 Handle	EPTLGM
#299 Conical Arkansas Stone	SS299



Luxating Elevator Kit	ELKIT
Luxating Elevator, Curved	EL3C
Luxating Elevator, Straight	EL3S
Luxating Elevator, Curved	EL5C
Luxating Elevator, Straight	EL5S
Ceramic Sharpening Stone for Luxating Elevators, Medium Grit	SSLUX

Atraumatic Extraction Kit, Black Line	IMNATRETX
Luxating Hybrid Elevator, Small Straight, Black Line	EPTSM SX
Luxating Hybrid Elevator, Small Curved, Black Line	EPTSM CX
Luxating Hybrid Elevator, Straight Spade, Black Line	EPTSSPX
35 Atraumair Apical Forceps	FAF35XS
36 Atraumair Apical Forceps	FAF36XS
2/4 Molt DE Curette, Black Line	CM2/4X
Crile-Wood Needle Holder	NHCW
16 Goldman-Fox Scissors, Curved, Super-Cut, Black Line	S16SCX
#5 Scalpel Handle	10-130-05E
9 Molt Periosteal Elevator, Black Line	P9X
Hinged Instrument Clips, 6 Pack	IM1002
Large Cassette - 20 Instrument, Red	IMN4200

Atraumatic Extraction Kit	IMATRAEXT
Luxating Hybrid Elevator, Small Straight, #6 Handle	EPTSMS
Luxating Hybrid Elevator, Small Curved, #6 Handle	EPTSMC
Luxating Hybrid Elevator, Straight Spade, #6 Handle	EPTSSP
Apical Forceps 150	FAF150
Apical Forceps 151	FAF151
2/4 Molt DE Curette, #6 Handle, Short	CM2/4S6
Crile-Wood Needle Holder	NHCW
16 Goldman-Fox Scissors, Curved, Super-Cut	S16SC
#5 Scalpel Handle, Round Straight	10-130-05
9 Molt Periosteal Elevator, #6 Handle	P96
Hinged Instrument Clips, 6 Pack	IM1002
Large Cassette - 16 Instrument, Gray	IM4161



Basic Perio Kit, Black Line	IMNBASPERX
Hinged Instrument Clips, 6 Pack	IM1002
#5 Front Surface Rhodium Single-Sided Mirror	MIR5
#6 Cone Socket Mirror Handle	MH6
#3 Scalpel Handle	10-130-03
1/2 Allen Modified Orban Knife, Round, Black Line	KO12KPO3RX
#23/QOW Thin Williams Expro, #6 Handle	XP23/QOW6
Gracey 11/12 Curette, #6 Handle	SG11/126
Gracey 13/14 Curette, #6 Handle	SG13/146
PR-3 Prichard Periosteal, Black Line	PPR3X
2/4 Molt DE Curette, Black Line	CM2/4X
S13K/TG DE Curette/Chisel, Black Line	S13K/TGX
Crile-Wood Needle Holder	NHCW
Large Cassette with Accessory Area - 12 Instrument, Gray	IMN4121
16 Goldman-Fox Scissors, Curved, Super-Cut, Black Line	S16SCX

Basic Perio Kit	IMBASPER
Large Cassette - 12 Instrument, Gray	IM4121
Hinged Instrument Clips, 6 Pack	IM1002
#5 Front Surface Rhodium Single-Sided Mirror	MIR5
#6 Cone Socket Mirror Handle	MH6
#3 Scalpel Handle	10-130-03
1/2 Allen Modified Orban Knife, Round, #6 Handle	KO12KPO3AR
#23/QOW Thin Williams Expro, #6 Handle	XP23/QOW6
Gracey 11/12 Curette, #6 Handle	SG11/126
Gracey 13/14 Curette, #6 Handle	SG13/146
PR-3 Prichard Periosteal, #6 Handle	PPR36
2/4 Molt DE Curette, #6 Handle, Short	CM2/4S6
13K/TG DE Curette/Chisel, #6 Handle	S13K/TG6
Crile-Wood Needle Holder	NHCW
16 Iris Scissors	S16



Bone Grafting Kit, Black Line	IMNBGKITX
Large Cassette with Accessory Area - 12 Instrument, Blue	IMN4128
#5 Scalpel Handle	10-130-05E
Euwe Bone Scoop/Plugger, #6 Handle	CSEUWES6
Microsurgical Suture Plier	SPM20
Buser Periosteal Elevator, Black Line	PPBUSERX
9 Molt Periosteal Elevator, Black Line	P9X
PJO/1 & PJO/3 Combined 13KL Chisel, Black Line	PPBUSER13X
PJO/2 & PJO/3 Combined 13KL Chisel, Black Line	PPBUSER23X
86 Lucas DE Surgical Curette, Black Line	CL86X
PR1/2 Prichard DE Curette, #6 Handle	SPR1/26
Measuring Cup with 25ml Markings	MCUPE
16 Goldman-Fox Scissors, Curved, Super-Cut, Black Line	S16SCX
Crile-Wood Needle Holder	NHCW
Membrane Placement Instrument, Black Line	PMPIX
Hinged Instrument Clips, 6 Pack	IM1002

Bone Grafting Kit	IMBGKIT
Large Cassette - 12 Instrument, Blue	IM4128
#5 Scalpel Handle, Round Straight	10-130-05
Euwe Bone Scoop/Plugger, #6 Handle	CSEUWES6
20 Corn Suture Plier	SP20
Buser Periosteal Elevator, #6 Handle	PPBUSER6
9 Molt Periosteal Elevator, #6 Handle	P96
PJO/1 & PJO/3 Combined 13KL Chisel, #6 Handle	PPBUSE1/36
PJO/2 & PJO/3 Combined 13KL Chisel, #6 Handle	PPBUSE2/36
86 Lucas DE Surgical Curette, #6 Handle	CL866
PR1/2 Prichard DE Curette, #6 Handle	SPR1/26
Measuring Cup with 25ml Markings	MCUPE
16 Iris Scissors	S16
Hegar-Baumgartner Needle Holder	NHHB
Membrane Placement Instrument	PMPI
Hinged Instrument Clips, 6 Pack	IM1002



Crestal Sinus Lift Kit, Black Line	IMNCREKITX
Large Cassette with Accessory Area - 16 Instrument, White	IMN4162
#3 Scalpel Handle	10-130-03
9 Molt Periosteal Elevator, Black Line	P9X
2/4 Molt DE Curette, Black Line	CM2/4X
Adson-Brown Perma Sharp™ Tissue Plier	TP5043
Euwe Bone Scoop/Plugger, #6 Handle	CSEUWES6
CP-20 Color-Coded Probe, #6 Handle	PCP65006
1 Palti Osteotome	OSTPAL1
2 Palti Osteotome	OSTPAL2
3 Palti Osteotome	OSTPAL3
4 Palti Osteotome	OSTPAL4
Woodson Periosteal, #6 Handle	PFIWDS16
Hinged Instrument Clips, 6 Pack	IM1002
Crile-Wood Perma Sharp™ Needle Holder	NH5038

Crestal Sinus Lift Kit	IMCRESTKIT
Large Cassette with Accessory Area - 16 Instrument, White	IM4162
#3 Scalpel Handle	10-130-03
9 Molt Periosteal Elevator, #6 Handle	P96
2/4 Molt DE Curette, #6 Handle, Short	CM2/4S6
43 Adson-Brown Tissue Pliers, Straight	TP43
Euwe Bone Scoop/Plugger, #6 Handle	CSEUWES6
CP-20 Color-Coded Probe, #6 Handle	PCP65006
1 Palti Osteotome	OSTPAL1
2 Palti Osteotome	OSTPAL2
3 Palti Osteotome	OSTPAL3
4 Palti Osteotome	OSTPAL4
Woodson Periosteal, #41 Handle	PFIWDS1
PR-3 Prichard Periosteal, #6 Handle, Short	PPR3S6

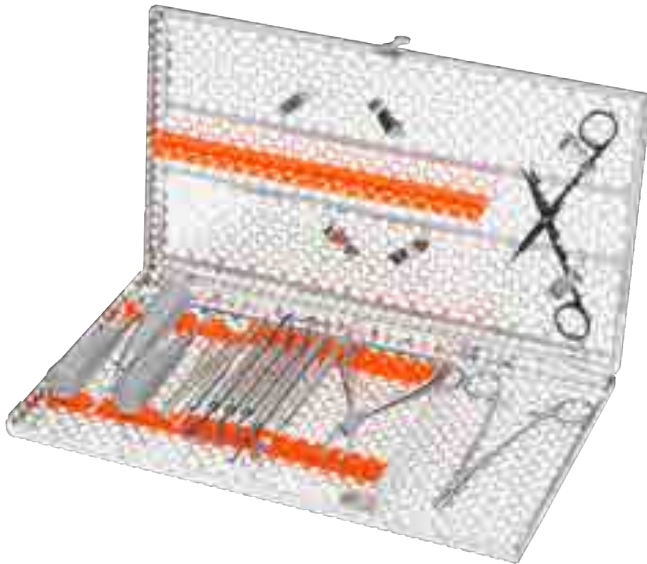

Extraction Kit, Black Line	IMNEXTKITX
Oral Surgery Cassette, Orange	IMNOS3
#5 Scalpel Handle	10-130-05E
9 Molt Periosteal Elevator, Black Line	P9X
Mayo-Hegar Needle Holder	NHMH
16 Goldman-Fox Scissors, Curved, Super-Cut, Black Line	S16SCX
86 Lucas DE Surgical Curette, Black Line	CL86X
301 Apexo Elevator	E301
Mini Cryer Left Elevator	E21
Mini Cryer Right Elevator	E22
2X Miller-Colburn Bone File, #6 Handle	BF2X6
13/14 Heidbrink DE Root Pick, Black Line	EHB13/14X
Friedman Rongeurs	RF
43 Adson-Brown Tissue Pliers, Straight	TP43
Luxating Hybrid Elevator, Straight Spade, Black Line	EPTSSPX
Hinged Instrument Clips, 6 Pack	IM1002

Extraction Kit	IMEXTKIT
Large Cassette - 16 Instrument, Orange	IM4163E2C4
#5 Scalpel Handle, Round Straight	10-130-05
9 Molt Periosteal Elevator, #6 Handle	P96
Mayo-Hegar Needle Holder	NHMH
16 Iris Scissors	S16
86 Lucas DE Surgical Curette, #6 Handle	CL866
301 Apexo Elevator	E301
34S Seldin Straight Elevator	E34S
2X Miller-Colburn Bone File, #6 Handle	BF2X6
13/14 Heidbrink DE Root Tip Pick, #6 Handle	EHB13/146
Friedman Rongeurs	RF
43 Adson-Brown Tissue Pliers, Straight	TP43
Luxating Hybrid Elevator, Straight Spade, #6 Handle	EPTSSP

Minimally Invasive Extraction Kit	MIEKIT
Luxating Elevator, Straight	EL3S
Luxating Elevator, Straight	EL5S
Luxating Elevator, Curved	EL3C
Luxating Elevator, Curved	EL5C
Periotome, Posterior	PT1
Periotome, Anterior	PT2
Apical Forceps 1	FAF1
Apical Forceps 150	FAF150
Apical Forceps 151	FAF151
Apical Forceps 222	FAF222
Apical Forceps X67A	FAFX67A
Apical Forceps X74N	FAFX74N
16 Instrument Signature Cassette, Blue	IM4168E4OR

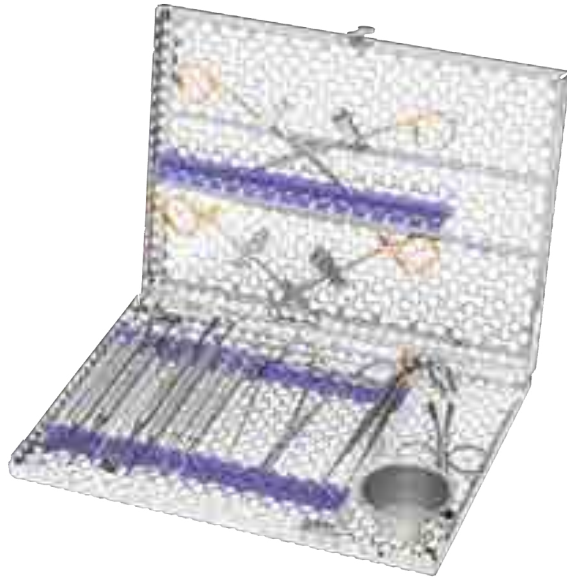

Keys Socket Grafting Kit	IMNKEYSGKT
Large Cassette with Accessory Area - 16 Instrument, Purple	IMN4164
23/CP-8 Expro, #6 Handle	XP23/86
2 Kelly Hemostat, Curved	H2
Gridsdale Bone Condenser, Black Line	PLGGR1X
2/4 Molt DE Curette, Black Line, Smooth	CM2/4X
#5 Scalpel Handle, Round Straight	10-130-05
PR-3 Prichard Periosteal, Black Line	PPR3X
Perma Sharp™ Halsey Needle Holder, Serrated	NH5037
Metzenbaum Perma Sharp™ Scissors, Curved, Blunt	S5055
DeBakey Perma Sharp™ Tissue Plier	TP5090
1 Dressing Pliers (Perry)	DP1
Membrane Placement Instrument, Black Line	PMP1X
Measuring Cup with 25ml Markings	MCUPE
Bone Grafting Syringe	SYBG
85 Lucas DE Surgical Curette, #6 Handle	CL856
S13K/TG Jovanovic 4MM Chisel, #6 Handle	PJO/16

Lateral Sinus Lift Kit, Black Line	IMNLATKITX
Large Cassette with Accessory Area - 16 Instrument, White	IMN4162
Kramer-Nevins Obtuse Sinus Lift Instrument, Large/Small, Black Line	IMP6578SX
Kramer-Nevins Acute Sinus Lift Instrument, Large/Small, Black Line	IMP6577SCX
Bone Packer DE	BPACK
Bone Grafting Syringe	SYBG
Crile-Wood Needle Holder	NHCW
16 Goldman-Fox Scissors, Curved, Super-Cut, Black Line	S16SCX
Urban Cheek Retractor	CRURBAN
Hinged Instrument Clips, 6 Pack	IM1002

Lateral Sinus Lift Kit	IMLATKIT
Large Cassette with Accessory Area - 16 Instrument, White	IM4162
Kramer-Nevins Obtuse Sinus Lift Instrument, Large/Small, #6 Handle	IMP65786
Kramer-Nevins Acute Sinus Lift Instrument, Large/Small, #6 Handle	IMP6577SC6
Bone Packer DE	BPACK
Bone Grafting Syringe	SYBG
Crile-Wood Needle Holder	NHCW
16 Goldman-Fox Scissors	S16
Urban Cheek Retractor	CRURBAN
Hinged Instrument Clips, 6 Pack	IM1002

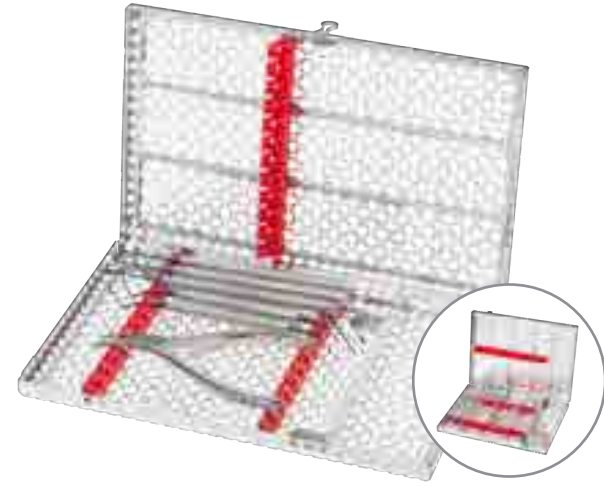

Microsurgical Kit, Black Line	IMNMICSURX
7 Mini Scalpel Blade Holder	10-130-70
13K/13KL DE Surgical Chisel, #9 Handle	S13K/13KL9
36/37 Back-Action DE Chisel, #9 Handle	C36/379
Diamond Dusted Plain Micro Tissue Pliers, Straight	8-905DD
Cortellini Castroviejo Microsurgical Needle Holder, Straight	NH5024CORT
Buser Periosteal Elevator, Black Line	PPBUSERX
Castroviejo Microsurgical Scissors, Black Line	SPVX
Large Cassette with Accessory Area - 12 Instrument, Gray	IMN4121
Qulix SE UNC Probe, 1-15, #6 Handle	PCPUNC156
#5 Front Surface Rhodium Single-Sided Mirror	MIR5
#6 Cone Socket Mirror Handle	MH6
Microsurgical Kit	IMMICSUR
7 Mini Scalpel Blade Holder	10-130-70
13K/13KL DE Surgical Chisel, #6 Handle	S13K/13KL6
36/37 Back-Action DE Chisel, #6 Handle	C36/376
Diamond Dusted Plain Micro Tissue Pliers, Straight	8-905DD
Cortellini Castroviejo Microsurgical Needle Holder, Straight	NH5024CORT
Buser Periosteal Elevator, #6 Handle	PPBUSER6
Castroviejo Microsurgical Scissors	SPV
Signa-Stat Cassette - 12 Instrument, Red	IM8120
Qulix SE UNC Probe, 1-15, #6 Handle	PCPUNC156
#5 Front Surface Rhodium Single-Sided Mirror	MIR5
#6 Cone Socket Mirror Handle	MH6

Rescue Kit, Black Line	IMNRESCUEX
Luxating Hybrid Elevator, Straight Spade, Black Line	EPTSSPX
Luxating Hybrid Elevator, Small Curved, Black Line	EPTSMCX
Luxating Hybrid Elevator, Small Straight, Black Line	EPTSMSX
13/14 Heidbrink DE Root Pick, Black Line	EHB13/14X
86 Lucas DE Surgical Curette, Black Line	CL86X
Mini Friedman Rongeurs	RMF
Large Cassette - 12 Instrument, Red	IMN8120
Rescue Kit	IMRESCUE
Luxating Hybrid Elevator, Straight Spade, #6 Handle	EPTSSP
Luxating Hybrid Elevator, Small Curved, #6 Handle	EPTSMC
Luxating Hybrid Elevator, Small Straight, #6 Handle	EPTSMS
13/14 Heidbrink DE Root Tip Pick, #6 Handle	EHB13/146
86 Lucas DE Surgical Curette, #6 Handle	CL866
Mini Friedman Rongeurs	RMF
IMS™ 1/2 Bur Cushion - Short Lid	IMS-1372SH
Large Cassette - 16 Instrument, Red	IM4160



Bone Spreading Kit		BONEKIT
Bone Spreading Cassette	IMDINOST	5.0 mm Osteotome Tapered Concave Tip, Straight OSTMSH50
2.7 mm Osteotome Tapered Convex Tip, Straight	OSTMSP27	2.7 mm Osteotome Tapered Concave Tip, Angulated OSTMSH27A
3.2 mm Osteotome Tapered Convex Tip, Straight	OSTMSP32	3.2 mm Osteotome Tapered Concave Tip, Angulated OSTMSH32A
3.7 mm Osteotome Tapered Convex Tip, Straight	OSTMSP37	3.7 mm Osteotome Tapered Concave Tip, Angulated OSTMSH37A
4.2 mm Osteotome Tapered Convex Tip, Straight	OSTMSP42	4.2 mm Osteotome Tapered Concave Tip, Angulated OSTMSH42A
5.0 mm Osteotome Tapered Convex Tip, Straight	OSTMSP50	5.0 mm Osteotome Tapered Concave Tip, Angulated OSTMSH50A
2.7 mm Osteotome Tapered Convex Tip, Angulated	OSTMSP27A	2.7 mm Osteotome Bone Pushers, Slightly Convex Tip, Straight OSTMPU27
3.2 mm Osteotome Tapered Convex Tip, Angulated	OSTMSP32A	3.2 mm Osteotome Bone Pushers, Slightly Convex Tip, Straight OSTMPU32
3.7 mm Osteotome Tapered Convex Tip, Angulated	OSTMSP37A	3.7 mm Osteotome Bone Pushers, Slightly Convex Tip, Straight OSTMPU37
4.2 mm Osteotome Tapered Convex Tip, Angulated	OSTMSP42A	4.2 mm Osteotome Bone Pushers, Slightly Convex Tip, Straight OSTMPU42
5.0 mm Osteotome Tapered Convex Tip, Angulated	OSTMSP50A	5.0 mm Osteotome Bone Pushers, Slightly Convex Tip, Straight OSTMPU50
2.7 mm Osteotome Tapered Concave Tip, Straight	OSTMSH27	2.7 mm Osteotome Bone Pushers, Angled OSTMPU27A
3.2 mm Osteotome Tapered Concave Tip, Straight	OSTMSH32	3.2 mm Osteotome Bone Pushers, Angled OSTMPU32A
3.7mm Osteotome Tapered Concave Tip, Straight	OSTMSH37	3.7 mm Osteotome Bone Pushers, Angled OSTMPU37A
4.2 mm Osteotome Tapered Concave Tip, Straight	OSTMSH42	4.2 mm Osteotome Bone Pushers, Angled OSTMPU42A
		5.0 mm Osteotome Bone Pushers, Angled OSTMPU50A
		Interchangeable Osteotome Handle OSTMGRIF
Interchangeable Periosteal Kit		PTIKIT
Interchangeable Periosteal Handle	PTIH	Interchangeable Periosteal Tip, Angulated PTI9
Interchangeable Periosteal Tip, Straight Wide	PTI7	Interchangeable Periosteal Tip, Mesial/Distal Angulated PTI10
Interchangeable Periosteal Tip, Straight Narrow	PTI8	IMS Bur Cushion w/lid, holds 6 IMS-1372TH



Prolux™ Luxating Elevator Kits



Prolux™ Luxating Elevators Spade Kit, Satin Steel	PROLUXSPADES
ProLux Spade, Yellow	PROLUX1
ProLux Distal, Angle Spade, Purple	PROLUX4
ProLux Mesial, Angle Spade, Purple	PROLUX5
ProLux Spade, Right, Yellow	PROLUX2
ProLux Spade, Left, Yellow	PROLUX3
5 Instrument Infinity Series™ Exam Cassette, Black	IMN6057



Prolux™ Luxating Elevators Spade Kit, Black Line	PROLUXSPADEX
ProLux Spade, Yellow	PROLUX1X
ProLux Distal, Angle Spade, Purple	PROLUX4X
ProLux Mesial, Angle Spade, Purple	PROLUX5X
ProLux Spade, Right, Yellow	PROLUX2X
ProLux Spade, Left, Yellow	PROLUX3X
5 Instrument Infinity Series™ Exam Cassette, Black	IMN6057



Prolux™ Luxating Elevators Kit of 4	PROLUXKIT4
ProLux Small, Straight, 2.5mm Wide Tip, Green	PROLUX6
ProLux Small, Curved, 2.5mm Wide Tip, Blue	PROLUX7
ProLux Small, Distal Angle, 2.5mm, Purple	PROLUX8
ProLux Small, Mesial Angle, 2.5mm, Yellow	PROLUX9
Ceramic, Cyndrical Sharpening Stone	SSKC
5 Instrument Infinity Series™ Exam Cassette, Black	IMN6057



Key Opinion Leader Kits



Jovanovic Full Implant/Bone/Soft Tissue Kit	SJOVANKIT
Black Line Mirror Handle, Cone Socket (QTY: 2)	MH6B
#5 HD Black Line Mirror, Cone Socket (QTY: 2)	MIR5HDB
Qulix SE UNC Probe, 1-15	PCPUNC15CH
#5 Scalpel Handle	10-130-05E
Microsurgical Scalpel Handle	SHDPV
Sinus Lift Instrument SE	PESIM1
Jovanovic Implant Instrument	IMPJO6
Sub-0 Vision Curvette	SGCSUB-0
PR-3 Prichard Periosteal, Black Line	PPR3X
Mini Me Microsurgical Periosteal, Black Line	PFIWDS1MKX
University of Minnesota Retractor, Black Line	CRMX
Cheek Retractor Simion	CRMS
Sinus Lift, Single-End, #6 Handle	PESIM16
Jovanovic Implant Instrument, #6 Handle	IMPKO66
Jovanovic Sinus Lift Instrument	IMPO76
86 Lucas DE Surgical Curette, Black Line	CL86X
KRA-3 Kramer DE Curette, #6 Handle	SKRA36
Sub-0 Vision Curvette, #6 Handle	SGCSUB-06
#4R4L Columbia Curette, EverEdge 2.0, #9 Handle	SC4R/4L9E2
S13K/TG Comb. 4mm, #6 Handle	PJO16
Jovanovic Mini Periodontal Chisel, 2mm	PJO/2M6
Jovanovic Mini Periodontal Chisel, 3mm	PJO/3M6
Jovanovic Plugger, Black Line	PLGJO/4X
Jovanovic Bone Condenser/Periosteal	PLGJO/56
14 LaGrange Scissors, Curved, Super-Cut, Black Line	S14SCX
Goldman-Fox Scissors, Straight, Super-Cut, Black Line	S20SCX
General Perma Sharp™ Tissue Plier	TP5070
6 DeBakey Perma Sharp™ Tissue Pliers	TP5090
Micro Tissue Plier, Straight	TPSLCOSM
Perma Sharp™ Castroviejo Needle Holder, Round	NH5024R
Diamond Dusted Castroviejo Microsurgical Needle Holder, Straight	NHDPV
20-Instrument IMS™ Infinity Series™ Oral Surgery Cassette, Orange (Made-to-Order)	IMNO203

Jovanovic Essential Implant Kit	SJOVANEKIT
Probe UNC #UNC15 CH HdI Qulix, 1-15	PCPUNC15CH
Scalpel Handle No. 5	10-130-05E
Microsurgical Scalpel Handle/Steel	SHDPV
PR-3 Prichard Periosteal, Black Line	PPR3X
Mini Me Micro. Periosteal, Black Line	PFIWDS1MKX
Sinus Lift Inst, Single End #6 Handle	PESIM16
Jovanovic Sinus Lift Instrument	IMPJO76
86 Lucas DE Surgical Curette, Black Line	CL86X
KRA-3 Kramer DE Curette #6 HDL	SKRA36
4R4L Columbia Curette, EE2 #9 Handle	SC4R/4L9E2
S13K/TG COMB. 4 MM #6 Handle	PJO/16
Jovanovic Bone Condenser/Periosteal	PLGJO/56
Gold. Fox, Strt, SC Scissors, Black Line	S20SCX
DeBakey Perma Sharp 6 Tissue Pliers	TP5090
Perma Sharp Castro Needle Holder, Rnd	NH5024R
Infinity 16 Inst Cassette, Orange	IMN4163
2-Pack Sig Series Hinged Instr. Clip	IM1000

Raymond Implant Institute Kit	RAYKIT
Cone Socket Mirror Handle, Satin Steel	MH6
#5 HD CS Mirror SS, 1 Ea	MIR5HD
#23 /qw Expro #6 Satin Steel Handle	XP23/QW6
#5 Scalpel Handle, Round Straight	10-130-05
#3 Scalpel Handle	10-130-03
Dressing Pliers, Utility Pick-Up	DPU17
#43 Adson-Brown Tissue Pliers	TP43
#17 Iris Scissors, Straight	S17
Friedman Rongeurs-Mini	RMF
Di Dust Castro Needle Holder Crv 4.0-6.0	NHDCPVN
#1/2 Orban DE Knife, Satin Stee	KO1/26
9A Allen Periosteal Elevator	P9A6
#87 Lucas DE Surgical Curette #6 Handle	CL876
#10 Miller Surgical Curette Satin Steel	CM106
#3 Mosquito Hemostat - Curved	H3
Retractor University of Minnesota	CRM
Weider Cheek & Tongue Retractor-Small	CRW1
Bone Packer DE 6-8mm	BPACK
Syringe Anesthetic Aspir CW Style 1.8ml	SYRCW
Measuring Cup 25 MI With Marking	MCUPE
Infinity 16 Inst Cassette, Red	IMN4160

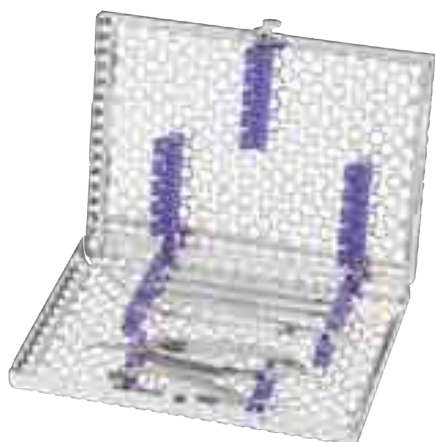

Allen/Johnston Suture Removal Kit	AJSRKIT
Castroviejo Microsurgical Needle Holder, Curved	NHM-5027
31 Castroviejo Scissors	S31
Combination #6 and #3 DE Explorer, #6 Handle	EXD66
#5 DE Explorer, #6 Handle	EXD56
Dressing Pliers, Utility Pick-Up	DPU17
Exam Cassette - 5 Instrument, Lavender	IMN5056E2

Allen Oral Plastic Surgery Kit	ALLENKIT
Large Cassette with Accessory Area - 16 Instrument, Red	IMN4160
Cook-Waite Anesthetic Aspirating Syringe	SYRCW
#5 Scalpel Handle, Round Straight	10-130-05
Qulix SE Probe, 3-6-8-11, #6 Handle	PCP116
#5 Front Surface Rhodium Single-Sided Mirror (QTY: 3)	MIR5/3
#6 Cone Socket Mirror Handle (QTY: 2)	MH6
Allen End-Cutting Intrasulcular Knife, Black Line	KPAX
Allen Arrowhead Knife, #9 Handle	KO12KP3R49
1/2 Allen Modified Orban Knife, Round, #9 Handle	KO12KPO3R9
Younger-Good 7/8 Curette, #9 Handle (QTY: 2)	SYG7/89E2
20 Corn Suture Plier	SP20
Diamond Dusted Plain Micro Tissue Pliers, Straight	8-905DD
Diamond Dusted Castroviejo Microsurgical Needle Holder, Straight	NHM-5026R
Goldman-Fox Perma Sharp™ Scissors, Straight	S5080
Periosteal, Allen Elevator, Black Line	PPAELX
Periosteal, Allen Elevator, Anterior, Black Line	PPAELAX
Periosteal, Allen Elevator, Posterior, Black Line	PPAELPX
Measuring Cup with 25ml Markings	MCUPE
Allen Membrane Measurement Card	ALLENCARD



Learn more about our Key Opinion Leader **Pat Allen.**

Allen Basic Kit, Black Line	ALLENBASIX
1/2 Allen Orban Knife, Black Line	KO12KPO3AX
1/2 Allen Modified Orban Knife, Round, Black Line	KO12KPO3RX
Allen End-Cutting Intrasulcular Knife, Black Line	KPAX
Periosteal, Allen Elevator, Black Line	PPAELX
Periosteal, Allen Elevator, Anterior, Black Line	PPAELAX
Inst. Sig Cassette, Blue	IM6058

Allen Basic Kit	ALLENBASIC
Allen Orban Knife 1/2 Satin Steel Handle	KO12KPO3A6
Modified Allen Orban Knife 1/2 Round	KO12KPO3AR
Allen End-cutting Intrasulcular Knife	KPA
Periosteal, Allen Elevator	PPAEL
Periosteal, Allen Elevator Anterior	PPAELA
5 Inst. Sig Cassette Red	IM6050

Steigmann Instrument Kit	STEIGKIT
Microsurgical Scalpel Handle	SHDPV
#5E Scalpel Handle	10-130-05E
Velvart Microsurgical Needle Holder, Diamond Dusted, 18cm	NHDPV
Microsurgical Scissors	SPV
Schlee Micro Tissue Pliers, Straight, 18cm	TPSLASCHLE
Cooley Micro Tissue Pliers, Straight, 18cm	TPSLCOSM
Periosteal Splitter Steigmann	PPSTEIG
Soft Tissue Splitter Steigmann, Modified	TKSTEIG2
Soft Tissue Splitter Steigmann	TKSTEIG



Koerner Basic Oral Surgery Kit	KOERNERKIT
Infinity 20 Instrument Cassette, Red	IMNOS200CA
Infinity 10 Instrument Cassette, Red	IMN5100E5
#3 Scalpel Handle	10-130-03
23 Seldin Periosteal Retractor	P23
9 Molt Periosteal Elevator, Black Line	P9X
Mayo-Hegar Perma Sharp™ Needle Holder	NH5042
Apical Forceps 151	FAF151
Apical Forceps 150	FAF150
301 Apexo Elevator	E301
1 Kelly Scissors, Curved	S1
#2 Heidbrink Root Tip Pick	EHB2
#3 Heidbrink Root Tip Pick	EHB3
86 Lucas DE Surgical Curette, Black Line	CL86X
B Cogswell Elevator	EBSM
Mini Cryer Left Elevator	E21
Mini Cryer Right Elevator	E22
Luxating Elevator, Straight, Black Line	EL3SX
2X Miller-Colburn Bone File	BF2X
30° Blumenthal Rongeurs	RBL
Luxating Hybrid Elevator, Straight Spade, #6 Handle	EPTSSP
43 Adson-Brown Tissue Pliers, Straight	TP43

Suzuki Basic Perio Surgery Kit	SUZUKIKIT
Signa-Stat Cassette with Accessory Area - 12 Instrument, Blue	IM8128C4
#5 Front Surface Rhodium Single-Sided Mirror	MIR5
#6 Cone Socket Mirror Handle	MH6
23/QOW Thin Williams Expro, #7 Handle	XP23/QOW7
Dressing Pliers, Utility Pick-Up	DPUI7
#3 Scalpel Handle (QTY: 2)	10-130-03
#1/2 Orban DE Knife, #9 Handle	KO1/29
#2/4 Molt DE Curette, #6 Short	CM2/4S6
McCall 17/18 Curette, #6 Handle	SM17/186
#13/TG DE Curette/Chisel, #6 Handle	S13K/TG6
Crile-Wood Needle Holder	NHCW
#16 Goldman-Fox Scissors	S16
1S/2S Sugarman DE File	FS1/2S6
Type A Anesthetic Aspirating Syringe, 1.8 ml	SYRA

Urban General Surgery Kit	URBANGSKIT
Cone Socket Mirror #6 Handle	MH6
#5 HD Mirror, Single-sided, Cone Socket	MIR5HD
#17 Dressing Pliers	DP17
UNC15/12 Color Probe, DE, #6 Handle	PCNC15/126
#5 Scalpel Handle	10-130-05E
Mini Me Microsurgical Periosteal, Black Line Handle	PFIWDS1MKX
PR-3 Prichard Periosteal, Black Line Handle	PPR3X
Scaler Ball #B-2/3, #6 Handle	SB2/36
Micro Tissue Plier Stg 18cm	TPSLCOSM
Needle Holder Simion	NH5024SIM
16 Goldman-Fox Scissors, Curved, Serrated, SuperCut, 12.5cm	S16SC
DeBakey Perma Sharp™ Tissue Pliers	TP5090
Retractor University of Minnesota	CRM
#4 Mosquito Hemostat, Straight	H4
IMS™ 1/2 Bur Cushion Short Lid, 6 Burs	IMS-1372SH
Periotome Black Line, Posterior	PT1X
Urban Chisel	CURBAN1
16 Instrument IMS™ Cassette, Green, 8"x11", 4 Posted Clips	IM4169C4
Mouth Prop (Adult Pair)	MP54
Urban Sinus Lift Instrument #4	IMPURBAN46

Malo All-On-4 Surgery Kit	MALALL4KIT
Large Cassette - 12 Instrument, Red	IM4120
Hinged Instrument Clips, 2 Pack	IM1000
#5 Scalpel Handle, Round Straight	10-130-05
DeBakey Perma Sharp™ Tissue Plier	TP5091
Lichtenberg Perma Sharp™ Needle Holder	NHLBPSB
Bishop Cheek Retractor	CRB
84 Lucas DE Surgical Curette, #6 Handle	CL846
88 Lucas DE Surgical Curette, #6 Handle	CL886
Malo Periosteal, #9 Handle	PP5689
3A/UNC15 Expro, #6 Handle	XP3A/NC156
Kelly Perma Sharp™ Scissors, Straight	S5002
Beyer Rongeurs	RBEY
Implant Retractor	IR



Urban Sinus Lift Kit	URBANSLKIT
PR-3S Periosteal Prichard, #6 Handle	PPR3S6
Jovanvic Plugger DE, #6 Handle	PLGJO/46
Urban Cheek Retractor	CRURBAN
Urban Sinus Lift Instrument #1, #6 Handle	IMPURBAN16
Urban Sinus Lift Instrument #2, #6 Handle	IMPURBAN26
Urban Sinus Lift Instrument #3, #6 Handle	IMPURBAN36
10 Instrument IMS™ Signature Series™ Cassette, Gray	IM5101



Learn more about our Key Opinion Leader [Istvan Urban](#).



The PM Nanos A (Angulated), EverEdge™ 2.0, Perio Knife (PMNANOAS) helps in creating a partial or full thickness envelope flap during connective tissue grafting procedures.



Pink Matters Surgical Kit	PMKIT
#6 Black Line Cone Socket Mirror Handle	MH6B
#5 HD Black Line Double-Sided Mirror, Cone Socket	MIR5DSHDB
S204S, Matte Finish	S204SCCHE2
Microsurgical Mini Scalpel Blade/Mirror Handle, Stainless Steel	SHDPV
#5 European Style Matte Scalpel Handle	10-130-5EM
Quilix SE UNC Probe, 1-15	PCPUNC15CH
DeBakey Perma Sharp™ Tissue Plier	TP5090
Micro Tissue Plier, Straight	TPSLCOSM
Diamond Dusted Castroviejo Microsurgical Needle Holder, Curved	NHDCPVN
Castroviejo Microsurgical Scissors	SPV
18 Iris Scissors, Curved, Super-Cut, Black Line	S18SC
University of Minnesota Retractor, Black Line	CRMX
PM Nanos S Perio Knife, Straight	PMNANOSS
PM Nanos A Perio Knife, Angulated	PMNANOAS
PM Edge Crestal Bone Chisel, Short	PMEDGES
PM Split Periosteal	PMSPLITSX
PM Prodigy Surgical Curette	PMPRODIGYS
Oral Surgery Cassette, Black	IMOS7

Pink Matters Essential Kit	PMEKIT
#6 Black Line Cone Socket Mirror Handle	MH6B
PM Nanos S Perio Knife, Straight	PMNANOSS
PM Nanos A Perio Knife, Angulated	PMNANOAS
Micro Tissue Plier, Straight	TPSLCOSM
Diamond Dusted Castroviejo Microsurgical Needle Holder, Curved	NHDCPVN
Microsurgical Mini Scalpel Blade/Mirror Handle, Stainless Steel	SHDPV
Castroviejo Microsurgical Scissors	SPV
Infinity 10 Instrument Cassette, Black	IMN5107



Learn more about our partnership with [Pink Matters](#).



Aspirators

Ergonomic aspirator designs and various tip diameters allow for precision suction, helping to remove blood and fragments of tissue and bone without obstructing access to the surgical site.



Learn more about our [Aspirators](#).



Andrew-Pychon Aspirator (23 cm)
Includes silicone tube adaptor.

[ASPA](#)



B1 Byrd Self-Cleaning Aspirator (21.5 cm)
Includes silicone tube adaptor.

- 1.5 mm [ASPB1](#)
- 2 mm [ASPB2](#)
- 2.5 mm [ASPB3](#)

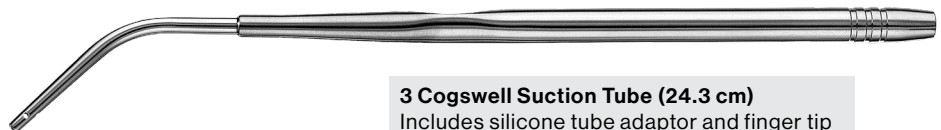

3 Cogswell Suction Tube (24.3 cm)
Includes silicone tube adaptor and finger tip hole to adjust aspiration.

[ASPCG3](#)

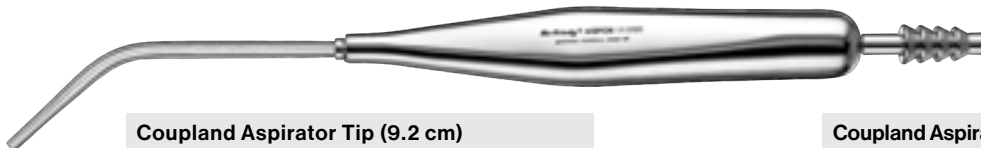

Coupland Aspirator Tip (9.2 cm)

- #1 Coupland Aspirator Tip (1.5 mm) **ASPCT1**
- #2 Coupland Aspirator Tip (2 mm) **ASPCT2**
- #3 Coupland Aspirator Tip (2.5 mm) **ASPCT3**
- #4 Coupland Aspirator Tip (3 mm) **ASPCT4**

Coupland Aspirator Handle (16.8 cm)
Includes silicone tube adaptor.
ASPCH

Coupland Aspirator Tip with Side Holes (9.2 cm)

- #1 Coupland Aspirator with Holes (1.5 mm) **ASPCT1W**
- #2 Coupland Aspirator with Holes (2 mm) **ASPCT2W**
- #3 Coupland Aspirator with Holes (2.5 mm) **ASPCT3W**
- #4 Coupland Aspirator with Holes (3 mm) **ASPCT4W**



Frazier Aspirator (17.8 cm)
Frazier aspirators come with removable wire stylet used to clean out bone fragments from the tip. Includes finger tip hole to adjust aspiration.

- 6 (1.5 mm) **ASPFR6**
- 8 (2 mm) **ASPFR8**
- 10 (2.5 mm) **ASPFR10**
- 12 (3 mm) **ASPFR12**



Stylet for Frazier Aspirator w/Ball (21 cm)
PTFSB

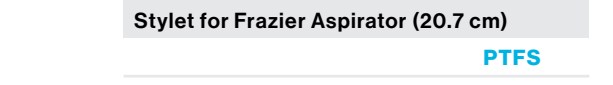

Stylet for Frazier Aspirator (20.7 cm)
PTFS



Oral Surgery Aspirator (22.8 cm)
Includes silicone tube adaptor.

- 1 mm **ASPOS1**
- 2 mm **ASPOS2**
- 3 mm **ASPOS3**
- 4 mm **ASPOS4**

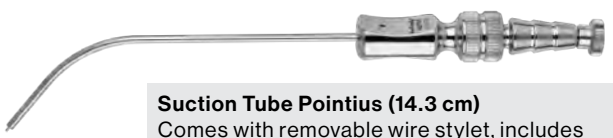

Suction Tube Pointius (14.3 cm)
Comes with removable wire stylet, includes silicone tube adaptor.
ASPON



Yankauer Tonsil Aspirator (30.5 cm)
Includes silicone tube adaptor.
ASPY



Aspirator Adaptor
To connect HuFriedyGroup aspirators with high-volume evacuation systems.
PTAA

Silicone Replacement Tubing (2")
PTRTC

4ft Long Silicone Replacement Tubing
PTRTCL



Calipers

Our selection of Calipers are used to measure bone or other oral structures.



Learn more about our [Calipers](#).

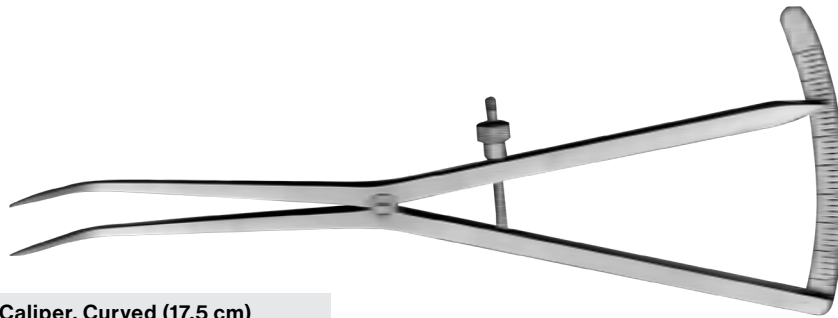

Castroviejo Caliper, Curved (17.5 cm)

Measures 0-40 mm [CLC40C](#)

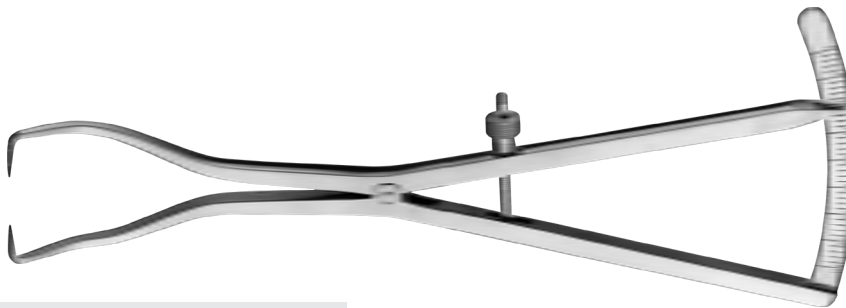

Weiss Modified Bone Caliper, Curved (16.6 cm)

40 mm [CLC40CWM](#)

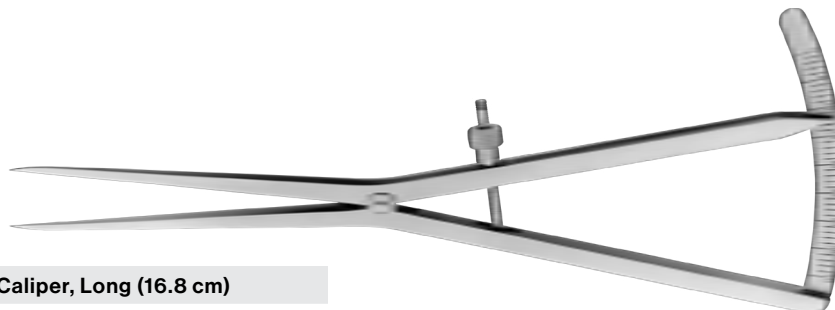

Castroviejo Caliper, Long (16.8 cm)

40 mm [CLC40L](#)

Chisels

Our bone chisels are meticulously handcrafted from the highest grade surgical stainless steel and engineered to provide optimal performance when reshaping and contouring bone or reflecting secondary palatal flaps.



Learn more about our [Chisels](#).

Periodontal Bone Chisels



36/37 Back-Action DE Chisel
 #9 [C36/379](#)
 #6 [C36/376](#)

Best in Practice Fact
 The Rhodes Back-Action Chisel is designed for use with a pull stroke. It is ideal for removing bone adjacent to the tooth without causing trauma and is especially useful on the distal of last molars.



1/2 Kramer-Nevins Chisel DE
 #6 [CKN1/26](#)



TG DE Chisel
 #6 [CTG6](#)
 #2 [CTG](#)



Modified TG with Ochsenbein Cutouts
 #6 [TG-O6](#)
 #2 [TG-O](#)



Urban Chisel
 #6 [CURBAN1](#)

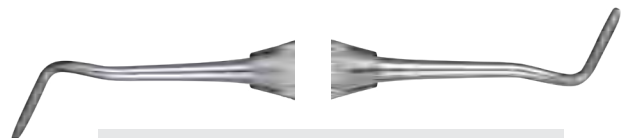

Urban Bone Chisel
 #6 [CURBAN2](#)



Ochsenbein Chisels

Ochsenbein Chisels are useful for reshaping bone. The semi-circular notches are beveled on each side. Can also be used to reflect flaps or remove secondary palatal flaps



Och-1 Ochsenbein SE Chisel

#524

CO1



Och-2 Ochsenbein SE Chisel

#6

CO26

#524

CO2

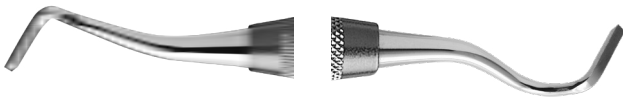

Och-3 Ochsenbein DE Chisel

#6

CO36

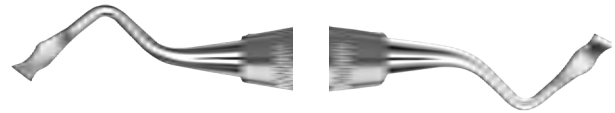

Och-4 Ochsenbein DE Chisel

#6

CO46

Fedi Chisels

Fedi Chisels are used for incisions that remove or recontour soft tissue. Also useful to excise interproximal tissue.



1 Fedi DE Chisel

#6

CPF16



2 Fedi DE Chisel

#6

CPF46



3 Fedi DE Chisel

#6

CPF36



4 Fedi SE Chisel

#6

CPF46

#24

CPF4

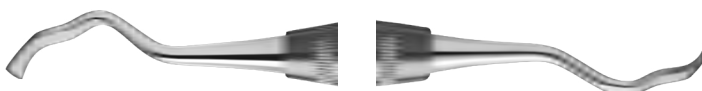

3/4 Solt DE Chisel

#6

CSOLT3/46

- **Best in Practice Fact**
- Ochsenbein and Fedi Chisels are designed to make secondary sulcular incisions in flap procedures and facilitate removal of remaining fibers on teeth.

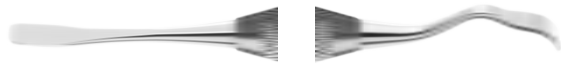

S13K/TG Jovanovic 4mm Chisel
4 mm / 4 mm

#6	PJO/16
#10	PJO/1



S13K/TG Jovanovic 5mm Chisel
5 mm / 5 mm

#6	PJO/26
#10	PJO/2



S13K/TG Jovanovic 6mm Chisel
6 mm / 6mm

#6	PJO/36
#10	PJO/3

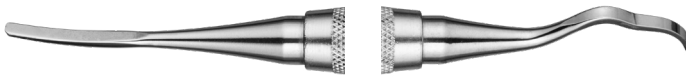

Jovanovic Mini Periodontal Chisel
2 mm

#6	PJO/2M6
----	-------------------------



Jovanovic Mini Periodontal Chisel
3 mm

#6	PJO/3M6
----	-------------------------



1/2 Buser Modified Periodontal Chisel
4 mm / 5 mm
PJO/1 & PJO/2 Combined 13KL Chisel

Black Line	PPBUSER12X
#6	PPBUSER1/26
#10	PPBUSER1/2



1/3 Buser Modified Periodontal Chisel
4 mm / 6 mm
PJO/1 & PJO/3 Combined 13KL Chisel

Black Line	PPBUSER13X
#6	PPBUSE1/36
#10	PPBUSER1/3



2/3 Buser Modified Periodontal Chisel
5 mm / 6 mm
PJO/2 & PJO/3 Combined 13KL Chisel

Black Line	PPBUSER23X
#6	PPBUSE2/36
#10	PPBUSER2/3

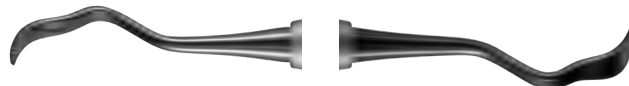

13K/13KL DE Surgical Chisel
3.2 mm / 4.9 mm

Black Line	S13K/13KLX
#9	S13K/13KL9
#6	S13K/13KL6
#2	S13K/13KL

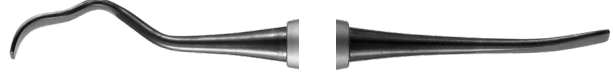

13K/TG DE Curette/Chisel
3.3 mm / 3.2 mm

Black Line	S13K/TGX
#9	S13K/TG9
#6	S13K/TG6
#6, Short	S13K/TGS6
#2	S13K/TG



Chisels • Bone



44/45 Remington DE Hoe Scaler

#6	S44/456
#2	S44/45



Chisel, Back Action

Black Line	SPAL13KX
#6	SPAL13K6
#6, Short	SPAL13KS6

Surgical

Bone Chisels • Single Bevel

Single bevel bone chisels are used for splitting teeth.



1 Chandler Bone Chisel
5 mm
CC1



2 Chandler Bone Chisel
5 mm
CC2



4 Chandler Bone Chisel
5 mm
CC4



1 Gardner Bone Chisel
3 mm
CG1



2 Gardner Bone Chisel
4 mm
CG2



5 Gardner Bone Chisel
4.3 mm
CG5



6 Gardner Bone Chisel
4 mm
CG6



9 Gardner Bone Chisel
4 mm
CG9

Bone Chisels • Bi-Bevel



Edentulous Ridge Chisel
4.8 mm *Initiates splitting bone ridges. Used with light taps from a mallet until 6mm depth is reached.*
GF366



7 Chandler Bone Chisel
4.7 mm
CC7



8 Chandler Bone Chisel
6.1 mm
CC8



9 Chandler Bone Chisel
7.1 mm
CC9



18 McFarland Bi-Bevel Chisel
4.2 mm
CM18



3 Kramer-Nevins Bone Chisel
7.5 mm *Sharp, mono-beveled long chisels are designed to widen the split bone.*
CKN3



55 Kramer-Nevins Bone Chisel
5.5 mm
CKN55

Our 55 and 75 Kramer-Nevins Bone Chisels are sharp and long, designed for contiguous bone grafting procedures and for compacting bony walls after bone grafting. Also useful for removal of exostosis and tori.



75 Kramer-Nevins Bone Chisel
7.5 mm
CKN75



1W Wakefield Bi-Bevel Chisel
2.7 mm
CW1



2W Wakefield Bi-Bevel Chisel
3 mm
CW2

Bone Chisels • Gouge



13 Chandler Bone Chisel
3.3 mm
CC13



15 Chandler Bone Chisel
6 mm
CC15

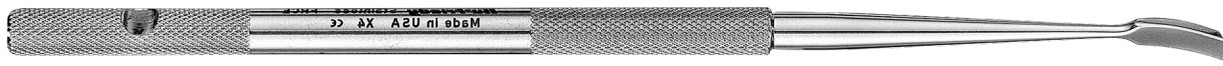

Freer Curved Elevator
FRCE



Buser Chisel, Pointed Tip
6 mm
CBFL112

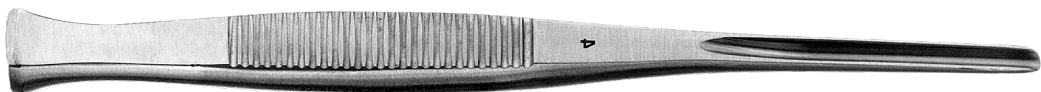

Buser Chisel, Round Tip
4 mm
CBFL214



The Pink Matters Crestal Bone Chisel is designed to elevate full thickness flap in the posterior area in preparation for implant placement.



PM Edge Crestal Bone Chisel, Short
Smooth
PMEDGES

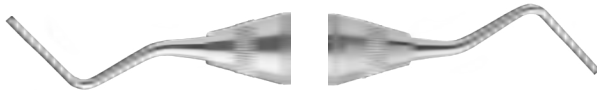

Tabanella Bone Chisel 1

#6

TABANELLA3

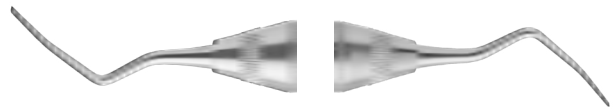

Tabanella Bone Chisel 2

#6

TABANELLA4

Surgical Currettes

Our portfolio of surgical currettes are engineered to effortlessly remove large calculus deposits and hard tissue during surgical and periodontal procedures.



Learn more about our **Currettes**.



2 mm

84 Lucas DE Surgical Curette

Black Line **CL84X**

#6 **CL846**

#522 **CL84**

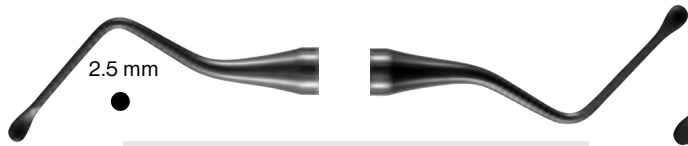

85 Lucas DE Surgical Curette	
Black Line	CL85X
#6	CL856
#522	CL85

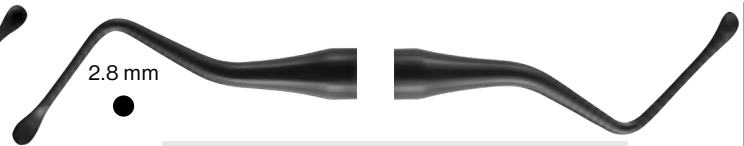

86 Lucas DE Surgical Curette	
Black Line	CL86X
#6	CL866
#522	CL86

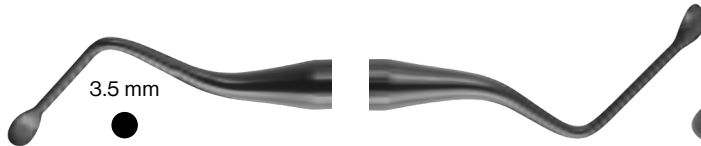

87 Lucas DE Surgical Curette	
Black Line	CL87X
#6	CL876
#522	CL87

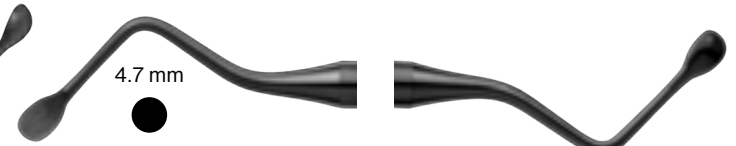

88 Lucas DE Surgical Curette	
Black Line	CL88X
#6	CL886
#522	CL88



8 Miller DE Surgical Curette	
#6	CM86
#522	CM8



9 Miller DE Surgical Curette	
#6	CM96
#522	CM9



10 Miller DE Surgical Curette	
#6	CM106
#522	CM10

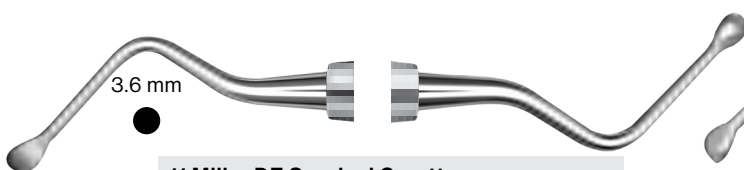

11 Miller DE Surgical Curette	
#6	CM116
#522	CM11

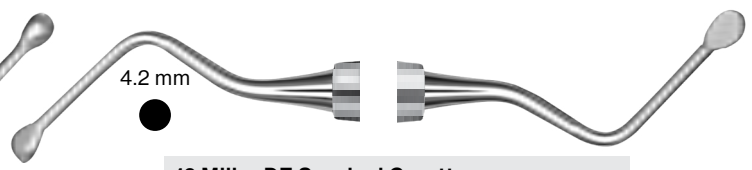

12 Miller DE Surgical Curette	
#6	CM126
#6, Short	CM12S6
#522	CM12



Surgical Currettes

Surgical



2 Molt SE Curette

#6	CM26
#502	CM2



4 Molt SE Curette

#6	CM46
#502	CM4



4 Molt SE Curette, Left, Modified

#510	CM4L
------	-------------



4 Molt SE Curette, Right, Modified

#510	CM4R
------	-------------



5L Molt SE Curette

#502	CM5L
------	-------------



6R Molt SE Curette

#502	CM6R
------	-------------



7.0 mm

3.5 mm

2/4 Molt DE Curette

Black Line	CM2/4X
#6, Short	CM2/4S6
#522	CM2/4



1 Hoexter Surgical Curette

#6	HOEXTER1
----	-----------------



2 Hoexter Surgical Curette

#6	HOEXTER2
----	-----------------



3 Hoexter Surgical Curette

#6	HOEXTER3
----	-----------------

- **Best in Practice Fact**
- Larger and heavier curettes used for the removal of granulation tissue
- often used to debride the alveolus,
- and can be used to carry bone grafting material.



Perio Surgical Currettes

Surgical



PM Prodigy Surgical Curette

Smooth **PMPRODIGYS**



8K/9K Kirkland DE Curette

#6 **SK8/96**

#2 **SK8/9**



3/4 Kramer-Nevins DE Curette

#6 **SKN3/46**

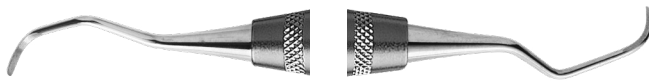

4 Kramer-Nevins DE Curette

#6 **SKN46**



KRA-1 Kramer DE Curette

#6 **SKRA16**



KRA-2 Kramer DE Curette

#6 **SKRA26**



KRA-3 Kramer DE Curette

#9 **SKRA39**

#6 **SKRA36**



PR1/2 Prichard DE Curette

#9 **SPR1/29**

#6 **SPR1/26**

#6, Short **SPR1/2S6**

#2 **SPR1/2**

#2, Short **SPR1/2S**

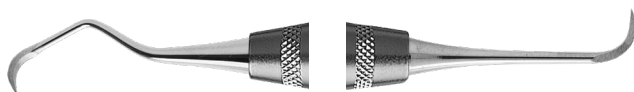

11/12 Sugarman DE Curette

#6 **SS11/126**

#2 **SS11/12**



5S/6S Sugarman DE Curette

#6 **SS5/66**

#2 **SS5/6**



9S/10S Sugarman DE Curette

#6 **SS9/106**

#2 **SS9/10**

Elevators

Handcrafted from Immunity Steel™ Alloy and heat treated to exacting specifications, our elevators are engineered with large diameter handles and permanently fixed working ends to optimize control and enhance strength.



Learn more about our [Elevators](#).

Elevator Handles

Black Line Elevator Handle*

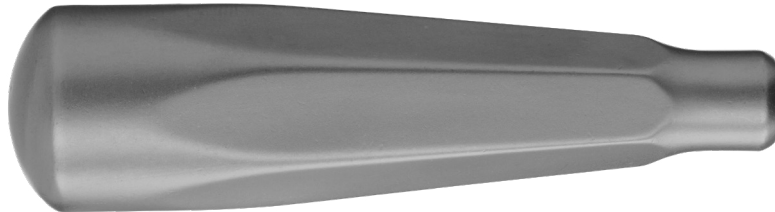

Standard Elevator Handle

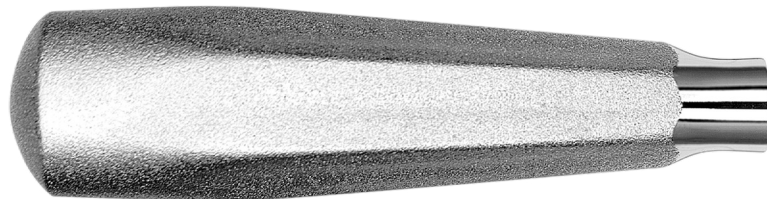

Small Elevator Handle

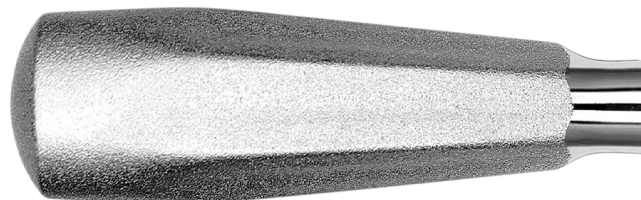

*Black Line products denoted with "X" at end of part code



Cryer Elevators



Mini Cryer Left Elevator
E21



Mini Cryer Right Elevator
E22



31 Cryer Elevator
Large
E31



32 Cryer Elevator
Large
E32



44 Cryer Elevator
Small
E44



45 Cryer Elevator
Small
E45



A30 Cryer Elevator
EA30



A31 Cryer Elevator
EA31



25 Cryer Elevator
Medium
E25



26 Cryer Elevator
Medium
E26

Coupland Gouge Elevators



1C Coupland (Gouge) Elevator
E1C



2C Coupland (Gouge) Elevator
Lower 3rd molars
E2C



3C Coupland (Gouge) Elevator
Lower 3rd molars
E3C

Coupland Gouge Elevators - English Patterns



#A1C Coupland Elevator (Gouge)
EA1C



#A2C Coupland Elevator (Gouge)
EA2C



#A3C Coupland Elevator (Gouge)
EA3C

Heidbrink Elevators

For upper and lower anterior teeth and roots



1 Heidbrink Straight Elevator
E1



2 Heidbrink Straight Elevator
E2



40 Heidbrink Straight Elevator
E40



41 Heidbrink Straight Elevator
E41

Seldin Elevators

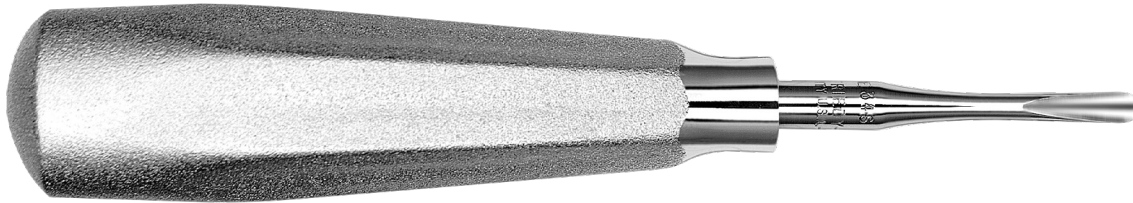

34S Seldin Straight Elevator	
Thinner tip and more narrow than 34 shank	
Standard	E34S
Small Handle	E34SSM
Serrated	E34SSERR



2 Seldin Elevator
Lower 3rd molars
E2S



3 Seldin Elevator
Upper and lower anterior roots
E3S



34 Seldin Straight Elevator
Upper and lower anterior roots
E34

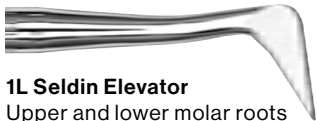

1L Seldin Elevator
Upper and lower molar roots
E1L



4L Seldin Elevator
Smaller version of E1L
E4L



301W Seldin Elevator
For displacement of deeply seated roots
E301W



1R Seldin Elevator
Upper and lower molar roots
E1R



4R Seldin Elevator
Smaller version of E1R
E4R



304W Seldin Elevator
For displacement of deeply seated roots
E304W

Apexo Elevators

For displacement of deeply seated roots



301 Apexo Elevator	
Standard	E301
Serrated	E301SERR
Small Handle	E301SM



302 Apexo Elevator
E302



303 Apexo Elevator
E303



4 Schmeckebier Apexo Elevator
E4



71 Miller Apexo Elevator
E71



73 Miller Apexo Elevator
E73



5 Schmeckebier Apexo Elevator
E5



72 Miller Apexo Elevator
E72



74 Miller Apexo Elevator
E74



Additional Elevators

..... Suggested Pair



6 Potts Elevator
For impacted 3rd molars without bony obstruction
E6



7 Potts Elevator
For impacted 3rd molars without bony obstruction
E7



8 Crane Pick Elevator
E8



11 Stout Elevator
3rd molars
E11



11A Stout Elevator
3rd molars
E11A



11M MacMillan Elevator
E11M



12M MacMillan Elevator
E12M



13M MacMillan Elevator
E13M

..... Suggested Pair



15 Woodward Elevator
Lower molar roots
E15



16 Woodward Elevator
Lower molar roots
E16

..... Suggested Pair



19 Root Elevator
Shorter leverage for lower 1st and 2nd molar roots
E19



20 Root Elevator
Shorter leverage for lower 1st and 2nd molar roots
E20



23 Elevator
Shorter leverage for lower 1st and 2nd molar roots
E23



31 Friedman (Craig) Elevator
For upper and lower cuspids
E31F



32 Friedman (Craig) Elevator
For upper and lower cuspids
E32F

..... Suggested Pair



38 Elevator, Serrated
For removal of root fragments
E38



39 Elevator, Serrated
For removal of root fragments
E39



44C Bradley Elevator
For displacement of roots and 3rd molars
E44C



46 Elevator
Upper posterior roots
E46



46R Elevator
Upper posterior roots
E46R



51 Curtis Elevator
E51



52 Curtis Elevator
E52



E63 Elevator
E63

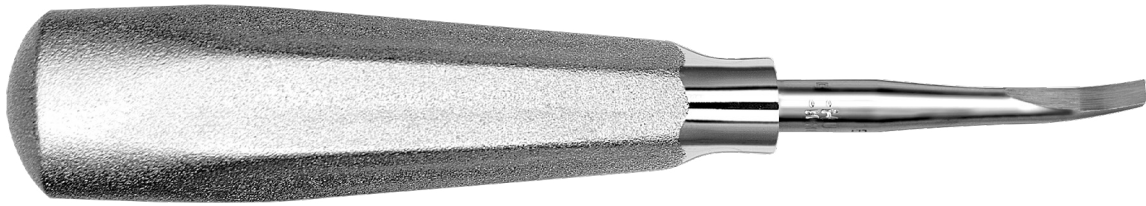

69W Woodward Chisel Elevator
E69W



77 Elevator, Serrated
For impacted 3rd molars without bony obstruction
E77



77R Elevator, Serrated

Standard **E77R**

Small Handle **E77RSM**



80 Elevator
E80



81A Elevator
For displacement of anterior roots
E81A



81E Elevator
For displacement of anterior roots
E81E



92 Elevator, Serrated
E92



93 Elevator, Serrated
E93



81 Elevator
Upper anterior roots and small teeth
E81



190 Elevator
E190



191 Elevator
E191



5 Hourigan Elevator
EH5



6 Hourigan Elevator
EH6



98 Elevator
Upper and lower 3rd molars
E98



A Cogswell Elevator
EA



B Cogswell Elevator

Standard **EB**

Small Handle **EBSM**



Warwick-James Elevator-Straight
#504
EWJS



Warwick-James Elevator-Left
#504
EWJL



Warwick-James Elevator-Right
#504
EWJR

.....Suggested Pair.....



T-Bar Handle Elevators

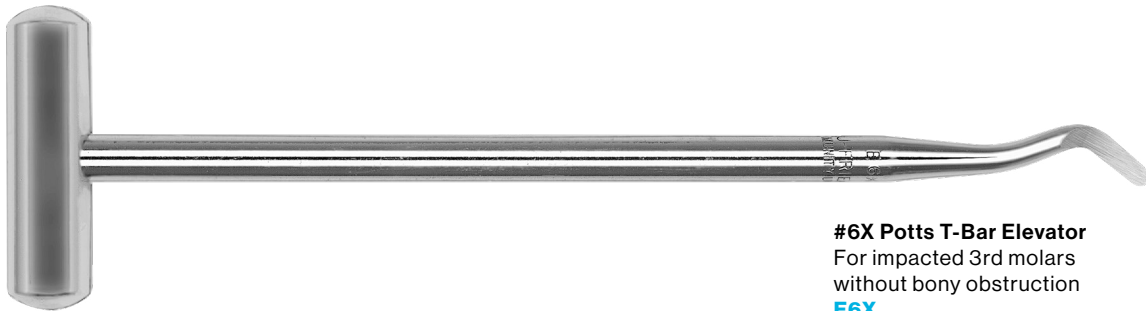

#6X Potts T-Bar Elevator
For impacted 3rd molars
without bony obstruction
E6X



#7X Potts T-Bar Elevator
For impacted 3rd molars
without bony obstruction
E7X

Winter Cross-Bar Handle Elevators

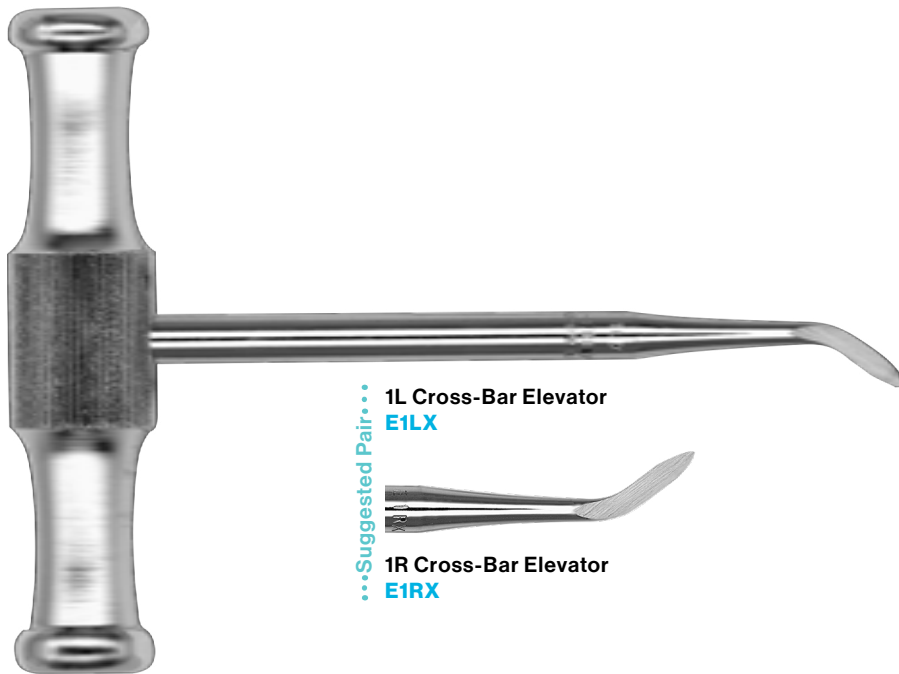

...Suggested Pair...
1L Cross-Bar Elevator
E1LX



...Suggested Pair...
1R Cross-Bar Elevator
E1RX



...Suggested Pair...
11L Cross-Bar Elevator
E11LX



...Suggested Pair...
11R Cross Bar Elevator
E11RX



...Suggested Pair...
12L Cross-Bar Elevator
E12LX



...Suggested Pair...
12R Cross-Bar Elevator
E12RX



...Suggested Pair...
14L Cross-Bar Elevator
E14LX



...Suggested Pair...
14R Cross-Bar Elevator
E14RX

Hoexter Elevators



Hoexter Mesial Luxating Elevator, Left
3 mm
EMLL3



Hoexter Mesial Luxating Elevator, Left
5 mm
EMLL5



Hoexter Mesial Luxating Elevator, Right
3 mm
EMLR3



Hoexter Mesial Luxating Elevator, Right
5 mm
EMLR5



Hoexter Distal Luxating Elevator, Left
3 mm
EDLL3



Hoexter Distal Luxating Elevator, Left
5 mm
EDLL5



Hoexter Distal Luxating Elevator, Right
3 mm
EDLR3



Hoexter Distal Luxating Elevator, Right
5 mm
EDLR5

Hoexter Kit	HOEXTERKIT
Hoexter Mesial Luxating Elevator, Left	EMLL3
Hoexter Distal Luxating Elevator, Left	EDLL3
Hoexter Mesial Luxating Elevator, Right	EMLR3
Hoexter Distal Luxating Elevator, Right	EDLR3
Hoexter Mesial Luxating Elevator, Left	EMLL5
Hoexter Distal Luxating Elevator, Left	EDLL5
Hoexter Mesial Luxating Elevator, Right	EMLR5
Hoexter Distal Luxating Elevator, Right	EDLR5
Ceramic, Cylindrical Sharpening Stone	SSKC
Hoexter Elevator, 8 Instrument Cassette	IM5080EKIT



Design Rationale:



Throughout history dentists have been taught to extract teeth in the easiest direction — towards the thinnest, supportive buccal bone. However, this technique leads to ischemic or traumatic bone loss of buccal bone resulting in cavernous buccal depressions that will not adequately support an implant. Based on personal experience, if a mesial/distal approach is used, the buccal and lingual bone is preserved and bone regeneration occurs. This enables successful implant positioning and predictable osseointegration. This is why the Hoexter Mesial/Distal Luxating Elevators are designed to protect the osseous ridge in tooth extractions by luxating roots in the mesio-distal plane.

– Dr. David Hoexter





Slim Luxating Elevators

Slim Luxating Elevators are 13-20% thinner than standard luxating elevators. They are used to sever periodontal ligaments and used in a rocking motion vs standard elevators which are used in a lifting motion. Short elevators are 10.16mm shorter than long elevators.



Slim Luxating Elevator, Long Curved 2 mm	
Black Line	ELSLIM2CLX
Standard	ELSLIM2CL



Slim Luxating Elevator, Short Curved 2 mm	
Black Line	ELSLIM2CSX
Standard	ELSLIM2CS



Slim Luxating Elevator, Long Straight 2 mm	
Black Line	ELSLIM2SLX
Standard	ELSLIM2SL



Slim Luxating Elevator, Short Straight 2 mm	
Black Line	ELSLIM2SSX
Standard	ELSLIM2SS



Slim Luxating Elevator, Long Curved 3 mm	
Black Line	ELSLIM3CLX
Standard	ELSLIM3CL



Slim Luxating Elevator, Short Curved 3 mm	
Black Line	ELSLIM3CSX
Standard	ELSLIM3CS



Slim Luxating Elevator, Long Straight 3 mm	
Black Line	ELSLIM3SLX
Standard	ELSLIM3SL



Slim Luxating Elevator, Short Straight 3 mm	
Black Line	ELSLIM3SSX
Standard	ELSLIM3SS

- **Best in Practice Fact**
- Luxating elevators are used with periotomes and apical forceps to conduct atraumatic extractions.



Download [Slim Luxating Elevators Info Sheet](#).

Standard Luxating Elevators

Luxating elevators have thin, sharp blades that are used to sever periodontal ligaments and used in a rocking motion vs standard elevators which are used in a lifting motion. Luxating elevators reduce putting pressure on adjacent teeth.



Luxating Elevator, Curved 2 mm	
Black Line	EL2CX
Standard	EL2C
Small Handle	EL2CSM



Luxating Elevator, Straight 2 mm	
Black Line	EL2SX
Standard	EL2S
Small Handle	EL2SSM



Luxating Elevator, Curved 3 mm	
Black Line	EL3CX
Standard	EL3C
Small Handle	EL3CSM



Luxating Elevator, Straight 3 mm	
Black Line	EL3SX
Standard	EL3S
Small Handle	EL3SSM



Luxating Elevator, Curved 4 mm	
Black Line	EL4CX
Standard	EL4C
Small Handle	EL4CSM



Luxating Elevator, Straight 4 mm	
Black Line	EL4SX
Standard	EL4S
Small Handle	EL4SSM



Luxating Elevator, Curved 5 mm	
Black Line	EL5CX
Standard	EL5C
Small Handle	EL5CSM



Luxating Elevator, Curved 5 mm	
Black Line	EL5SX
#510	EL5S
Small	EL5SSM

- Refer to [page A707](#) for a detailed listing of the [Luxating Elevator Kit](#).



Luxating Hybrid Elevators

Designed with thin, precisely angled tips and a large diameter handle, the Luxating Hybrids provide improved apical and interproximal access for enhanced oral adaption, aiding in the preservation of the buccal plate by severing the periodontal ligaments during atraumatic extractions.



Luxating Hybrid Elevator, Straight Spade	
Black Line	EPTSSPX
#6	EPTSSP



Luxating Hybrid Elevator, Small Straight	
Black Line	EPTSMSX
#6	EPTSMS



Luxating Hybrid Elevator, Small Curved	
Black Line	EPTSMCX
#6	EPTSMC



Luxating Hybrid Elevator, Large Distal	
Black Line	EPTLGD
#6	EPTLGD



Luxating Hybrid Elevator, Large Mesial	
Black Line	EPTLGMX
#6	EPTLGM



Luxating Hybrid Elevator, Small Distal	
Black Line	EPTSMDX
#6	EPTSMD



Luxating Hybrid Elevator, Small Mesial	
Black Line	EPTSMMX
#6	EPTSMM

- Refer to [page A706](#) for a detailed listing of the **Luxating Hybrid Elevator Kit, Black Line (IMNATREXTX)** and **Luxating Hybrid Elevator Kit (EPTKIT)**.



Ceramic Sharpening Stone for Luxating Elevators, Medium Grit	
Black Line	SSLUX

ProLux™ Luxating Elevators

Designed with thin, sharp working ends which allow for atraumatic extractions—they help to preserve the socket while gently luxating the tooth. This atraumatic approach can lead to increased patient comfort and enhanced healing, providing optimal clinical results



ProLux™ Spade, Yellow
 Black Line **PROLUX1X**
 Satin Steel **PROLUX1**



ProLux™ Spade, Right, Yellow
 Black Line **PROLUX2X**
 Satin Steel **PROLUX2**



ProLux™ Spade, Left, Yellow
 Black Line **PROLUX3X**
 Satin Steel **PROLUX3**



ProLux™ Spade, Right, Purple
 Black Line **PROLUX4X**
 Satin Steel **PROLUX4**



ProLux™ Spade, Left, Purple
 Black Line **PROLUX5X**
 Satin Steel **PROLUX5**

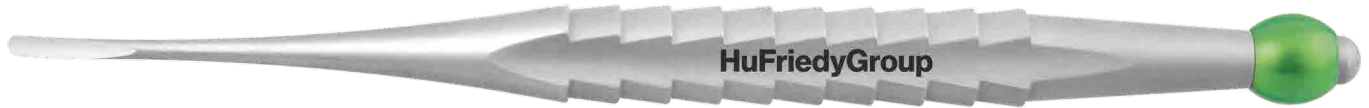

ProLux™ Small, Straight, 2.5mm Wide Tip, Green
Satin Steel **PROLUX6**



ProLux™ Small, Curved, 2.5mm Wide Tip, Blue
Satin Steel **PROLUX7**

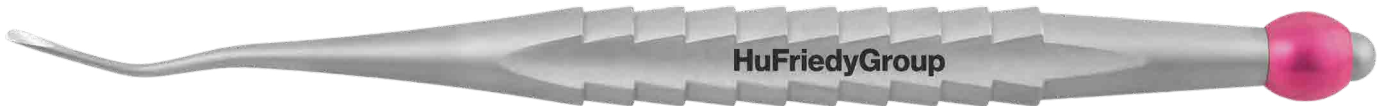

ProLux™ Small Distal Angle, Right, 2.5mm, Purple
Satin Steel **PROLUX8**



ProLux™ Small Distal Angle, Left, 2.5mm, Purple
Satin Steel **PROLUX9**

Syndesmotomes

Bernard elevators, also referred to as syndesmotomes, can be used as a periosteal elevator or to elevate small roots.



11 Straight Bernard Syndesmotome
Black Line **BER11X**
#504 **BER11**

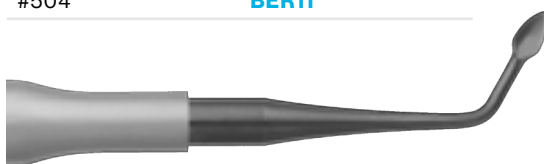

6 Right Bernard Syndesmotome
Black Line **BER6X**
#504 **BER6**



7 Left Bernard Syndesmotome
Black Line **BER7X**
#504 **BER7**



Bone Files

Our extensive line of Bone Files are used for final smoothing and shaping of bone.

Straight-Cut Bone Files

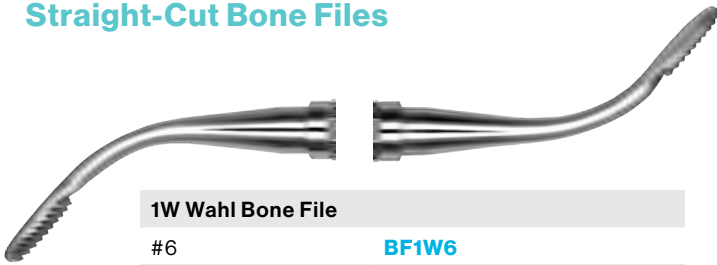

1W Wahl Bone File	
#6	BF1W6
#522	BF1W

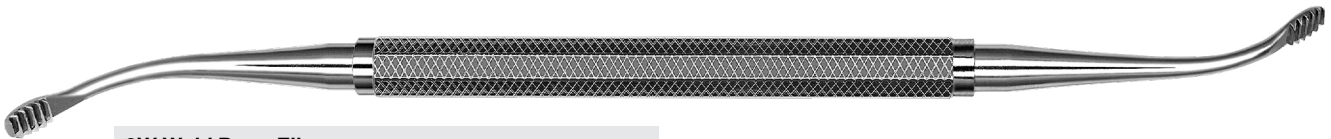
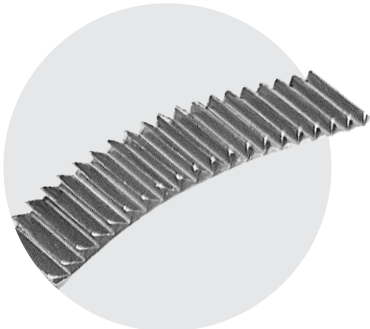

2W Wahl Bone File	
#6	BF2W6
#522	BF2W



12 Howard Bone File	
#6	BF126
#522	BF12



21 Miller Bone File	
Same design as the 1X Cross-Cut but with Straight-Cut.	
#6	BF216
#522	BF21



45 Miller Bone File
Same design as the 2X Cross-Cut but with Straight-Cut.

#6	BF456
#522	BF45



52 Miller Bone File

#6	BF526
#522	BF52



64 Miller Bone File

#6	BF646
#522	BF64

67 Howard Bone File

#6	BF676
#522	BF67

Cross-Cut Bone Files



1X Miller-Colburn Bone File
Small paddle-shaped end is half the size of the larger paddle-shaped end.

#6	BF1X6
#522	BF1X

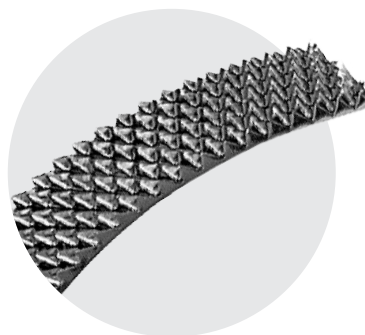

Cross-Cut files increase efficiency by cutting in two directions.



2X Miller-Colburn Bone File
Curved working end combined with a straight working end.

#6	BF2X6
#522	BF2X



3X Miller-Colburn Bone File
Curved working end combined with a small paddle-shaped working end.

#6	BF3X6
#522	BF3X



Periodontal Files

Used interproximally, our Periodontal Bone Files provide efficiency for both push and pull applications.



11/12 Buck DE File

#6	FB11/126
#522	FB11/12



1S/2S Sugarman File, Mesial/Distal

#6	FS1/2S6
#2	FS1/2S



3S/4S Sugarman File, Buccal/Lingual
For removal of granulosomatous tissue in supra-bony and infra-bony pockets.

#6	FS3/4S6
#2	FS3/4S

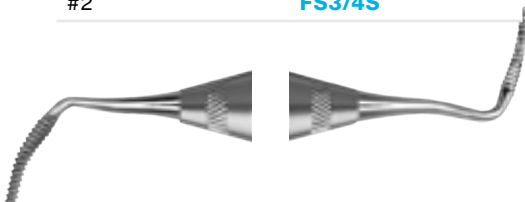

#9/10 Schluger, Curved

#6	FS9/10S6
#522	FS9/10S

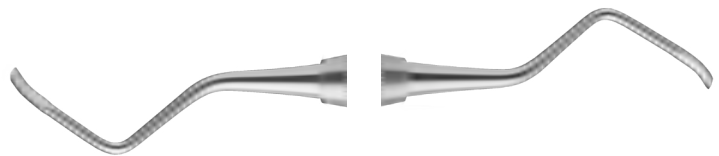

Tabanella Universal Bone File

	TABANELLA2
--	-------------------



We offer an extensive array of forceps for any form of extraction. From Apical to Atraumair and our newest line of Atlas Forceps which feature an internal spring hinge for enhanced performance, comfort, and control, our forceps will help you be **The Best in Practice**.



Learn more about our **Forceps**.

Diamond Dusted Forceps

Our Diamond Dusted Forceps feature a fine diamond coating which increases resistance between the forceps and tooth surface providing enhanced engagement. Diamond Dusted Forceps are available in an array of patterns which allows for full-mouth coverage.

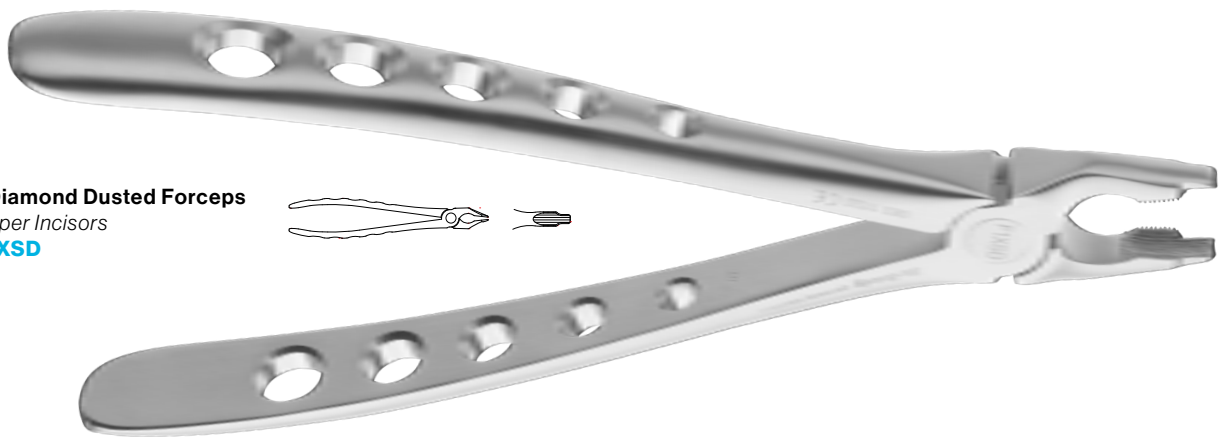

1 Diamond Dusted Forceps
Upper Incisors
F1XSD

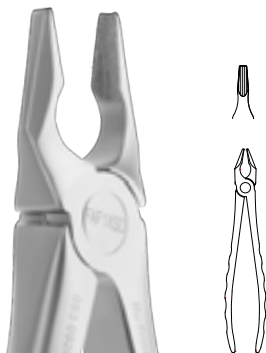

1 Diamond Dusted Apical Forceps
Upper Incisors
FAF1XSD

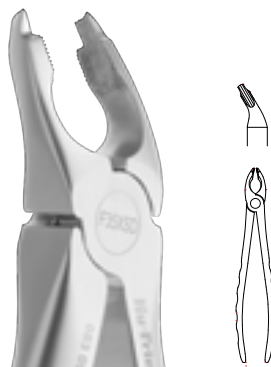

35 Diamond Dusted Forceps
Upper Canines and Premolars
F35XSD

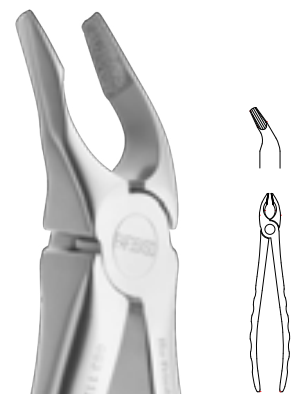

35 Diamond Dusted Apical Forceps
Upper Canines and Premolars
FAF35XSD



44 Diamond Dusted Root Forceps
Upper Roots
FX44XSD

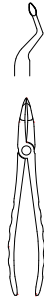

51 Diamond Dusted Root Forceps
Upper Roots
FX51XSD



21 Diamond Dusted Forceps
Lower 1st and 2nd Molars
F21XSD

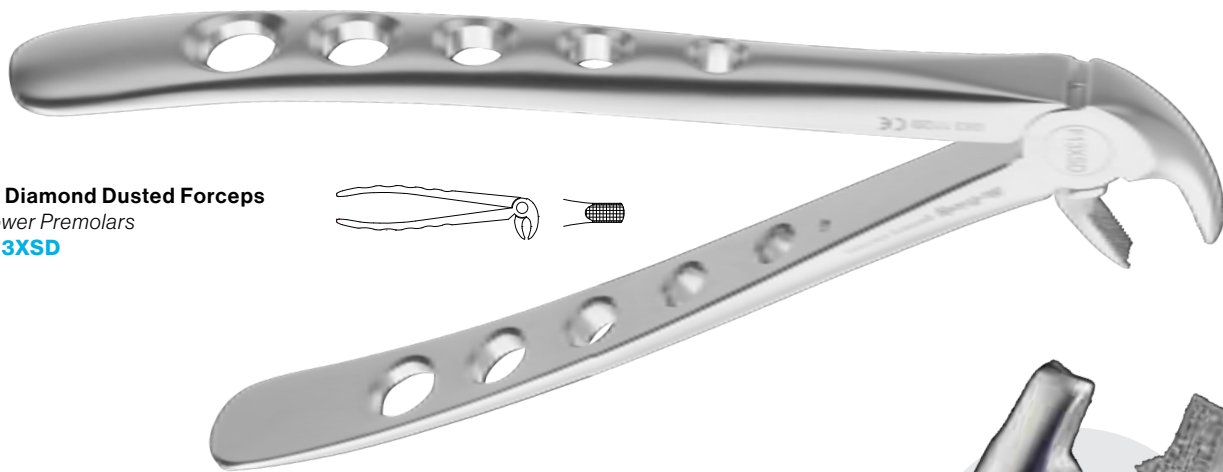

13 Diamond Dusted Forceps
Lower Premolars
F13XSD

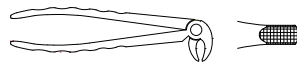

Learn more about our **Diamond Dusted Forceps.**

Best in Practice Fact
A light diamond coating bonded to longitudinal beak serrations increases grip by 20% compared to traditional forceps.*

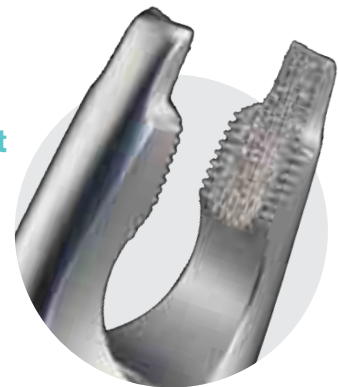

36 Diamond Dusted Forceps
Lower Incisors
F36XSD



36 Diamond Dusted Apical Forceps
Lower Premolars and Incisors
FAF36XSD

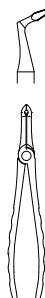

45 Diamond Dusted Root Forceps
Lower Roots, Serrated
FX45XSD

*Data on file compared to standard Hu-Friedy Forceps.

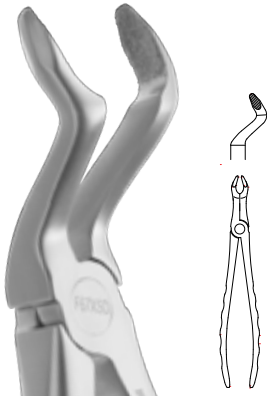

67 Diamond Dusted Apical Forceps
Upper Molars
F67XSD



73 Diamond Dusted Forceps
Lower Molars
FX73XSD

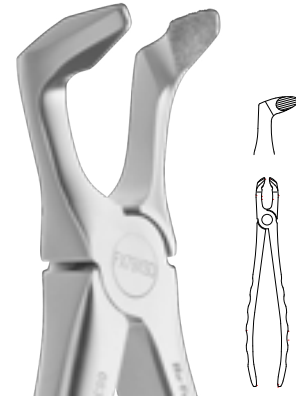

79 Diamond Dusted Forceps
Lower Molars
FX79XSD

Atlas Forceps

Atlas forceps, which are engineered with an internal spring hinge, provide performance, comfort and control while reducing manipulation of the forceps at the surgical site.

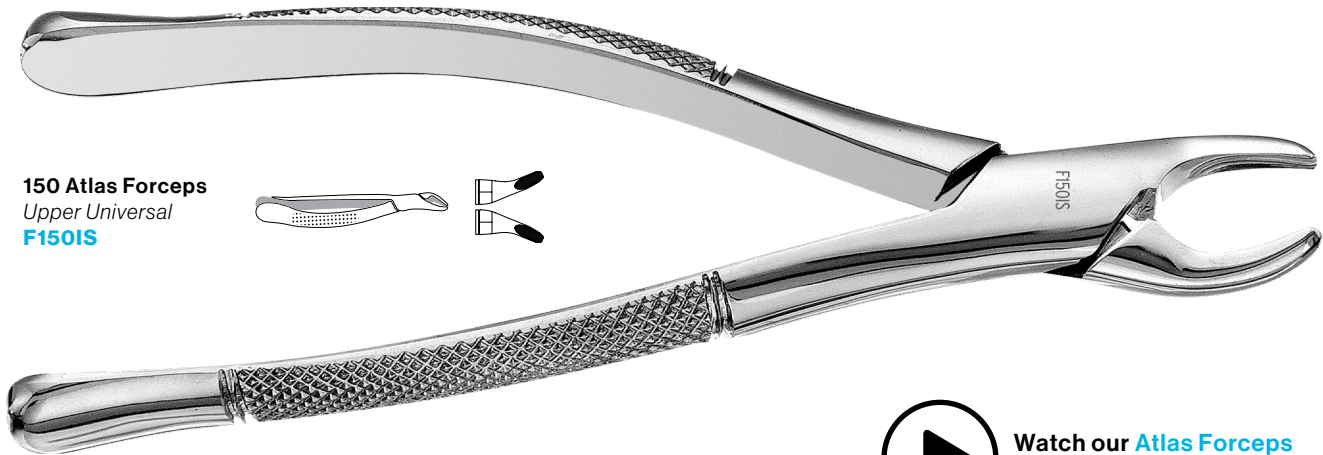

150 Atlas Forceps
Upper Universal
F150IS

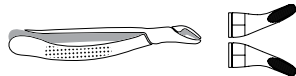

Watch our **Atlas Forceps** in use.



151 Atlas Forceps
Lower Universal
F151IS

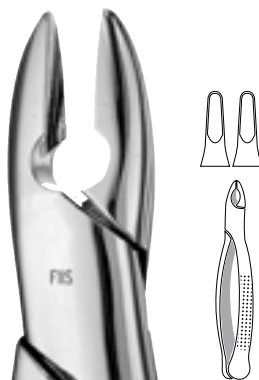

1 Atlas Forceps
Upper Anterior
F1IS



222 Atlas Forceps
Lower Molars
F222IS



23 Atlas Forceps
Cowhorn
F23IS

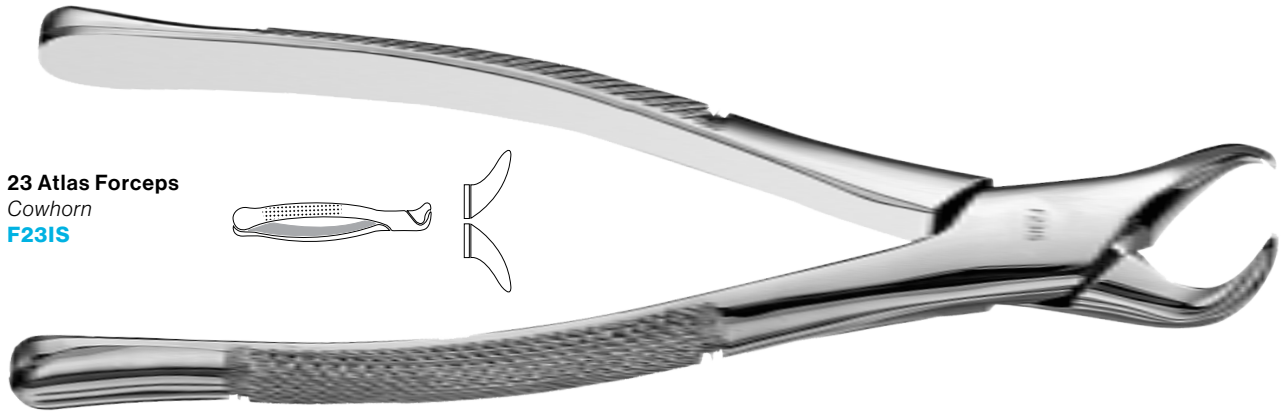

Learn more about
Atlas Forceps.

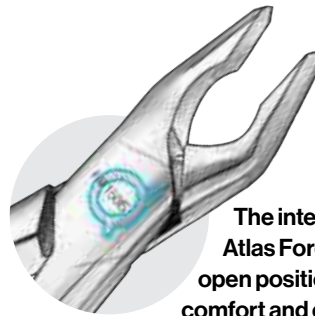

The internal springs in
Atlas Forceps maintain
open position, enhancing
comfort and control.



69 Tomes Atlas Forceps
Upper/Lower Roots
F69IS

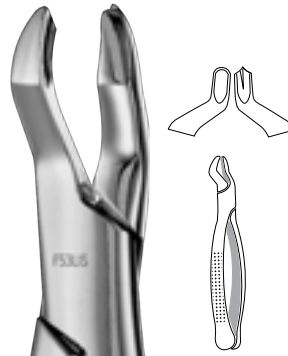

53L Atlas Forceps
Upper Molar, Left
F53LIS

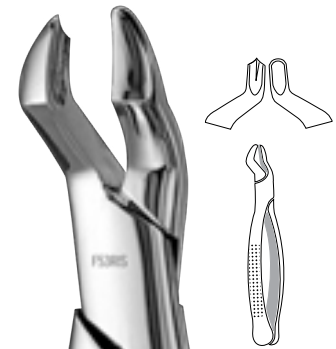

53R Atlas Forceps
Upper Molar, Right
F53RIS



88L Nevius Atlas Forceps
Upper Molar, Left
F88LIS



88R Nevius Atlas Forceps
Upper Molar, Right
F88RIS

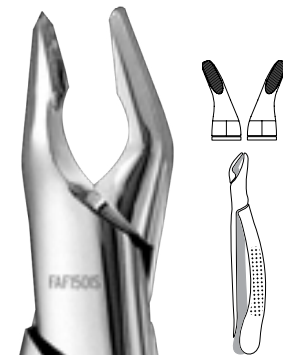

150 Atlas Forceps
Upper Universal, Apical
FAF150IS

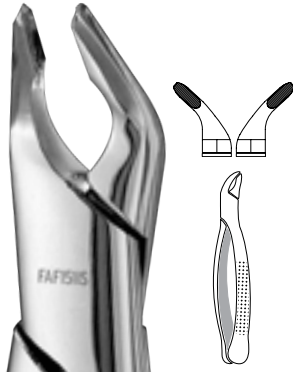

151 Atlas Forceps
Lower Universal, Apical
FAF151IS

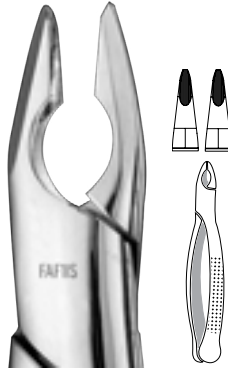

1 Atlas Forceps
Upper Anterior, Apical
FAF1IS



222 Atlas Forceps
Lower Molars, Apical
FAF222IS

Apical Forceps

Our forged Apical Forceps feature thin, anatomical tapered beaks and longitudinal serrations to penetrate the surrounding bone and firmly grasp the root and crown structure with multiple points of contact, reducing the chance of crushing or fracturing the crown. Clinicians therefore are able to preserve the bone and reduce the risk of root and buccal plate fractures, enhancing clinical outcomes.



Apical Forceps 1
Upper Anteriors
FAF1

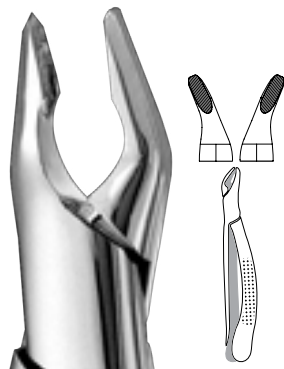
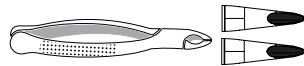

Apical Forceps 150
Upper Universal
FAF150

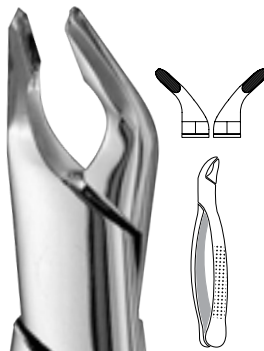

Apical Forceps 151
Lower Universal
FAF151

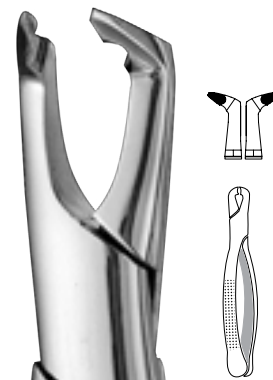

Apical Forceps 222
Lower Molars
FAF222

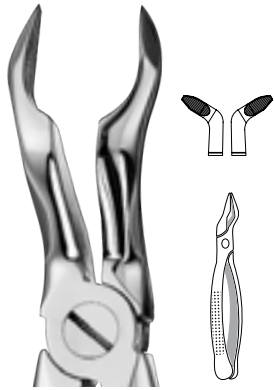

Apical Forceps X67A
Upper Molars
FAFX67A



Apical Forceps X74N
Lower Anteriors
FAFX74N



Learn more about our **Apical Forceps.**

Atraumair Forceps

Our Atraumair Forceps are designed for optimal access and enhanced crown and root engagement. Each of the 13 uniquely patterned forceps feature a *Matte Finish* for reduced light reflection. Unique hole designs help reduce the weight of the forceps and provide increased comfort and control. Atraumair forceps offer improved access for a variety of extraction cases through enhanced beak geometries.

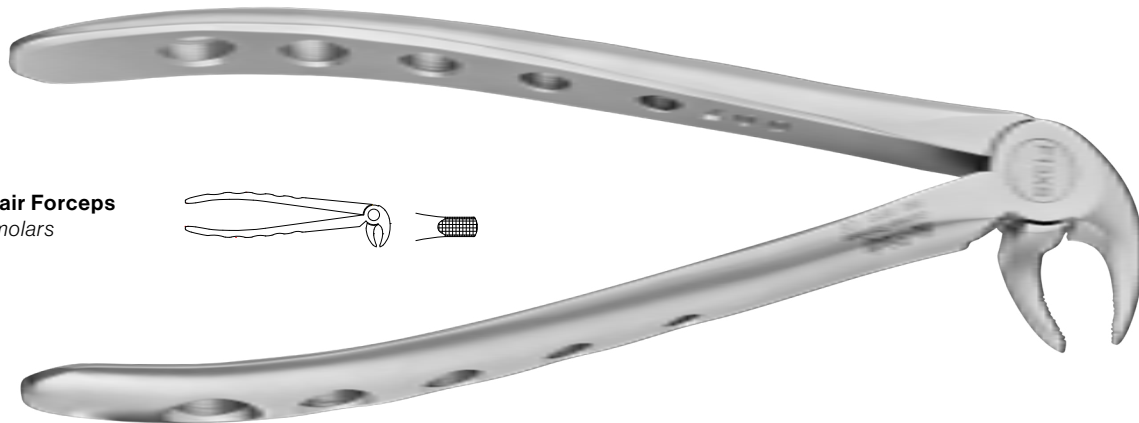

13 Atraumair Forceps
Lower Premolars
F13XS

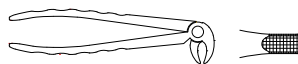

1 Atraumair Standard Forceps
Upper Incisors
F1XS



21 Atraumair Forceps
1st and 2nd Lower Molars
F21XS

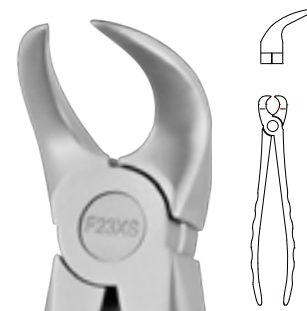

23 Atraumair Forceps
Cowhorn, Lower Molars
F23XS

35 Atraumair Forceps
Upper Can/Premolar
F35XS

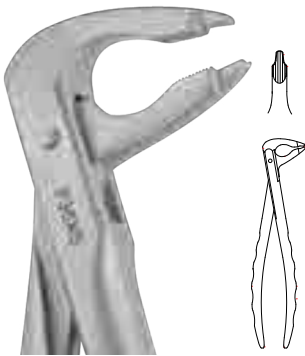
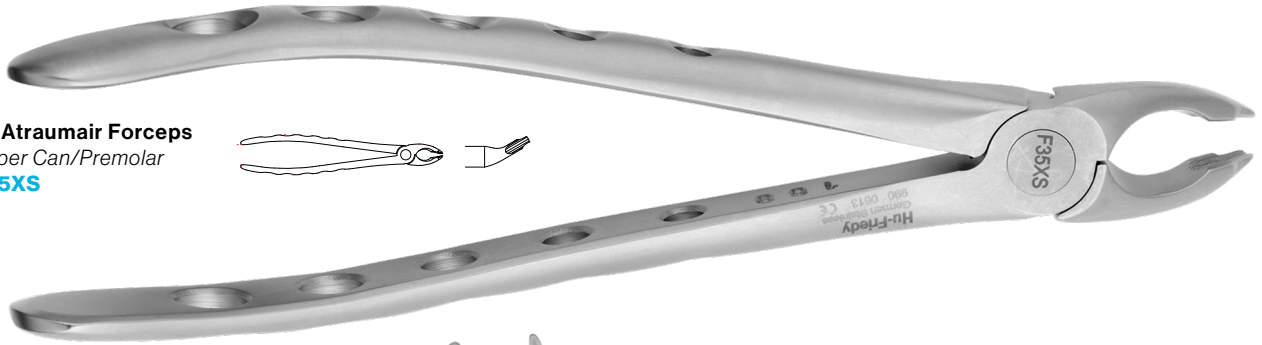

36 Atraumair Forceps
Lower Incisors
F36XS

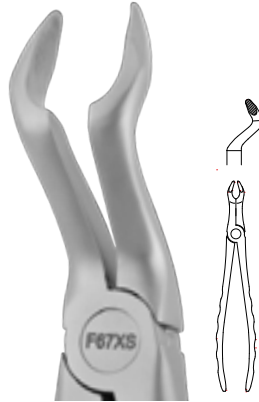

67 Atraumair Forceps
Upper Molars
F67XS



1 Atraumair Apical Forceps
Upper Incisors
FAF1XS



35 Atraumair Apical Forceps
Upper Can/Premolar
FAF35XS



36 Atraumair Apical Forceps
Lower Premolars/Incisors
FAF36XS

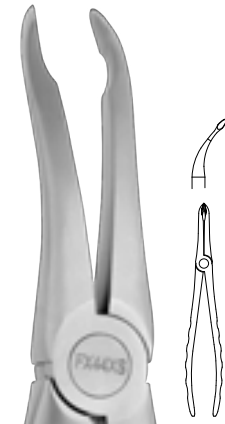

44 Atraumair Forceps
Universal, Upper Root
FX44XS

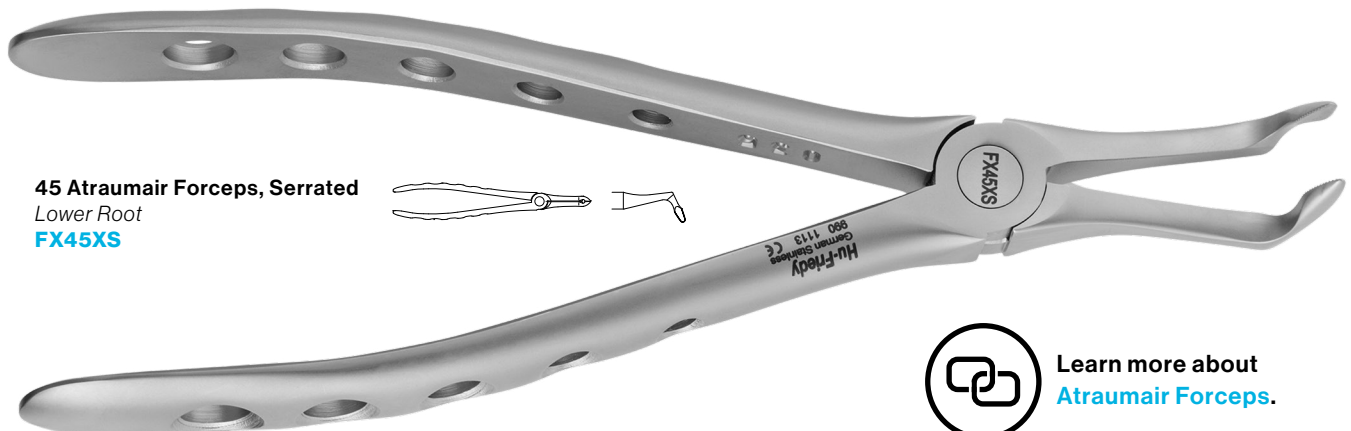

45 Atraumair Forceps, Serrated
Lower Root
FX45XS



Learn more about
Atraumair Forceps.

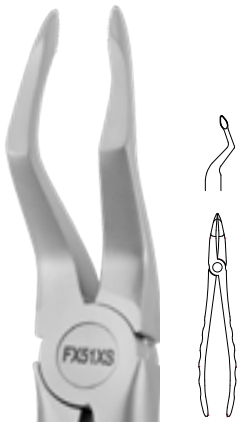

51 Atraumair Forceps, Serrated
Upper Root
FX51XS



73 Atraumair Forceps
Lower Molars
FX73XS



79 Atraumair Forceps
Lower Molars
FX79XS

Lower Anteriors and Premolars

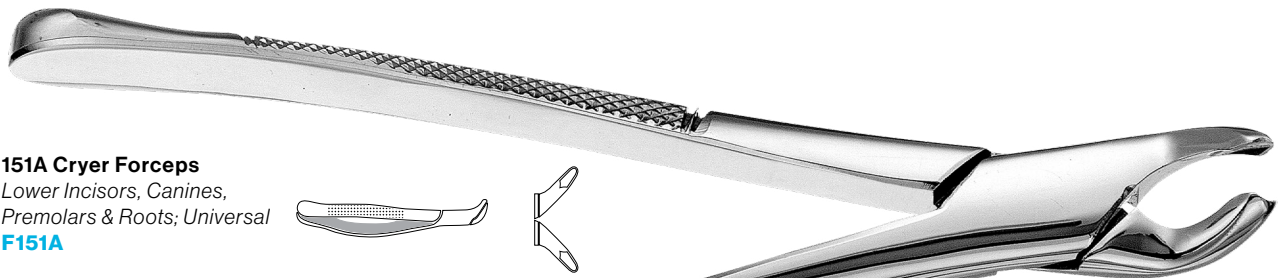

★ **151A Cryer Forceps**
Lower Incisors, Canines,
Premolars & Roots; Universal
F151A

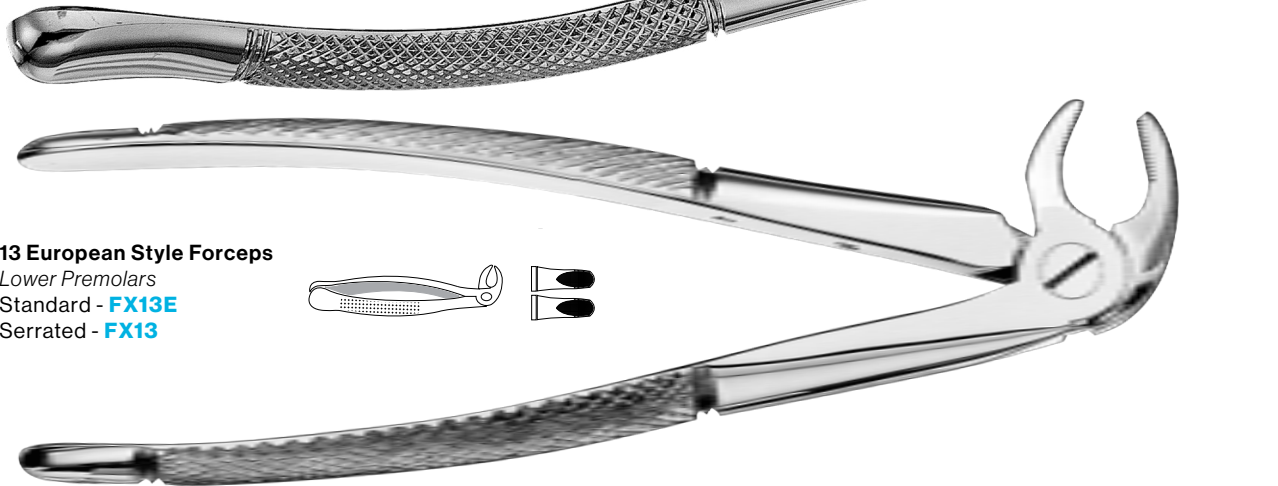

13 European Style Forceps
Lower Premolars
Standard - **FX13E**
Serrated - **FX13**

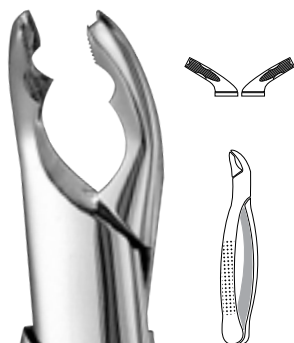

★ **151AS Split Beak Forceps, Serrated**
Lower Incisors, Canines, Premolars &
Roots; Universal
F151AS

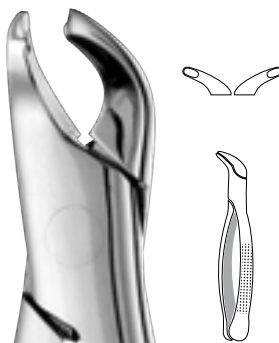

★ **203 Forceps**
Lower Incisors, Canines, Premolars &
Roots; Universal
F203

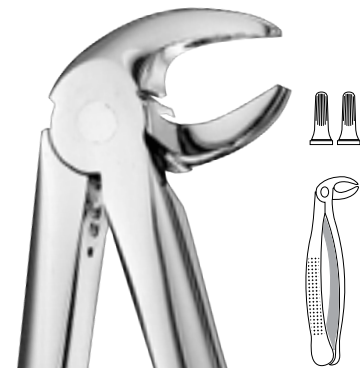

MD-3 Mead Forceps, Serrated
Lower Incisors & Roots
FMD3

★ = **Presidential® Forceps** are superbly constructed from forged stainless steel, meticulously crafted and finished with a precision hinge. All HuFriedyGroup Presidential Forceps carry a lifetime warranty against defects in material and workmanship.

Lower Molars



★ **16 Forceps**
1st & 2nd Lower Molars
Straight Handle **F16M**
Standard **F16**



★ **17 Forceps**
1st & 2nd Lower Molars
F17

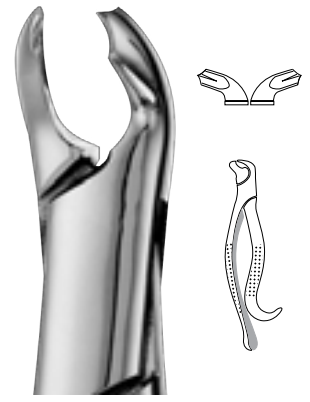

217 Hu-Friedy Forceps
1st & 2nd Lower Molars, Beaks
identical to #17
F217



★ **222 Forceps**
3rd Lower Molars
F222

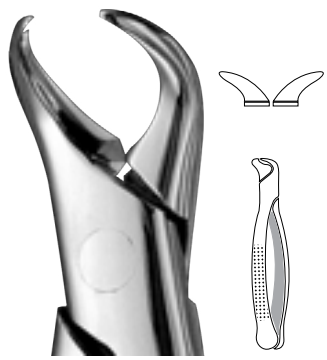

★ **23 Forceps**
1st & 2nd Lower Molars
F23

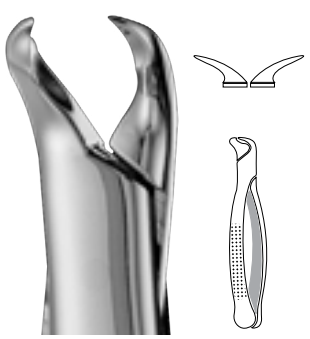

3FS Woodward Forceps
Lower Molars
F3FS

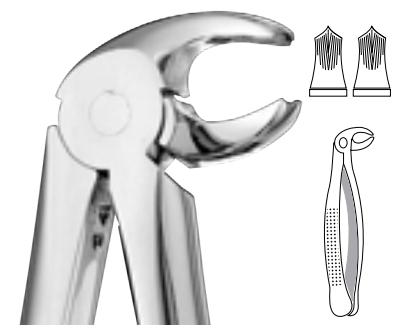

MD-4 Mead Forceps, Serrated
Lower 1st, 2nd, & 3rd Molars
FMD4

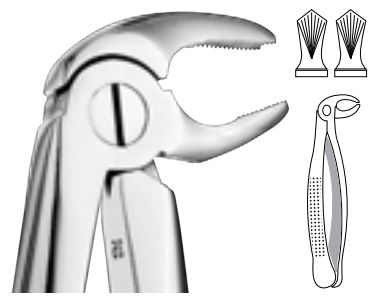

22 European Style Forceps
Lower Molars
Standard
Matte Finish **FX22**
FX22E



73 European Style Forceps, Serrated
Lower Molars
FX73

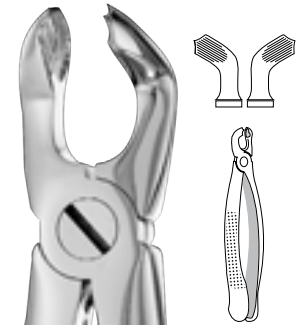

79 European Style Forceps, Serrated
Lower 3rd Molars
Standard
Matte Finish **FX79**
FX79E



Lower Universal

Surgical



★ **#151 Cryer Forceps**
Lower Incisors, Canines,
Premolars & Roots; Universal
F151

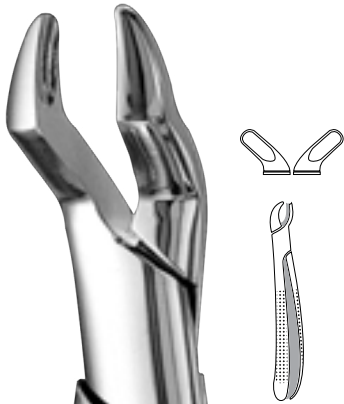

★ **#10S Forceps**
Upper Molars
F10S



★ **#18L Harris Forceps**
1st & 2nd Upper Molars; left. Pointed beak
for engaging bifurcated buccal root.
Unique "palm up" handle design for use
when standing behind the patient.
F18L



★ **#18R Harris Forceps**
1st & 2nd Upper Molars; right.
Pointed beak for engaging
bifurcated buccal root.
F18R

..... Suggested Pair

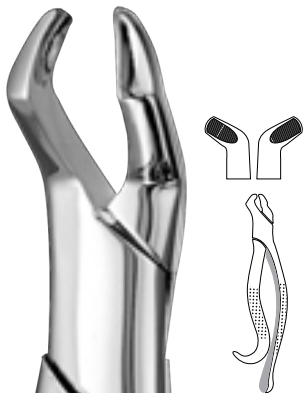

★ **#210H Forceps**
3rd Upper Molars
F210H

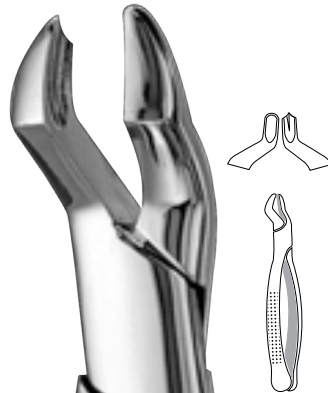

★ **#53L Forceps**
1st & 2nd Upper Molars; left. Pointed beak
for engaging bifurcated buccal root.
F53L

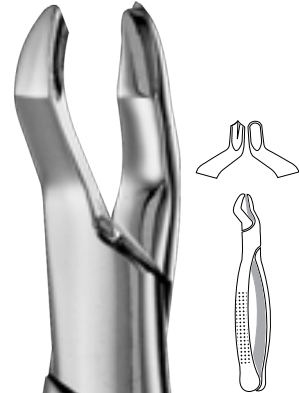

★ **#53R Forceps**
1st & 2nd Upper Molars; right. Pointed beak
for engaging bifurcated buccal root.
F53R

..... Suggested Pair

★ = **Presidential® Forceps** are superbly constructed from forged stainless steel, meticulously crafted and finished with a precision hinge. All HuFriedyGroup Presidential Forceps carry a lifetime warranty against defects in material and workmanship.



Upper Molars



★ **210S Forceps**
3rd Upper Molars
F210S

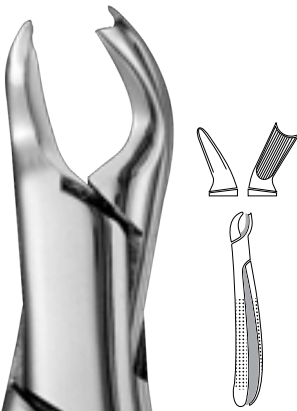

89 Cook Forceps
Upper Molars; right.
F89



90 Cook Forceps
Upper Molars; left.
F90

..... Suggested Pair

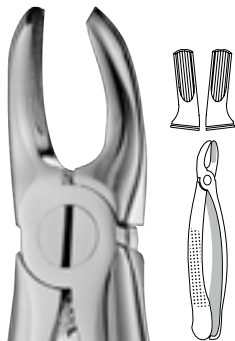

MD-2 Mead Forceps, Serrated
Upper 1st, 2nd, & 3rd Molars, Universal
FMD2

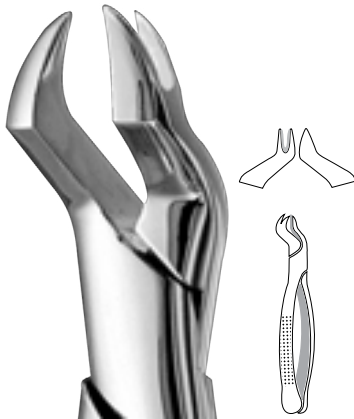

★ **88L Nevius Forceps**
1st & 2nd Upper Molars. Split beak
for engaging palatal root.
F88L

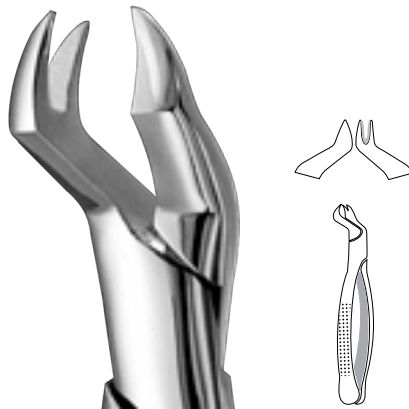

★ **88R Nevius Forceps**
1st & 2nd Upper Molars. Split beak
for engaging palatal root.
F88R

..... Suggested Pair

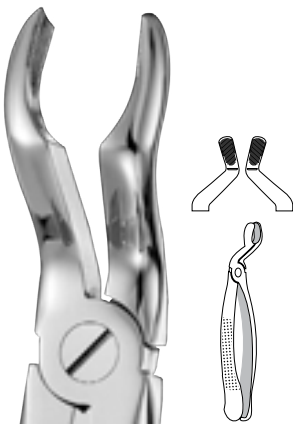

67A European Style Forceps, Serrated
Upper 3rd Molars
FX67A

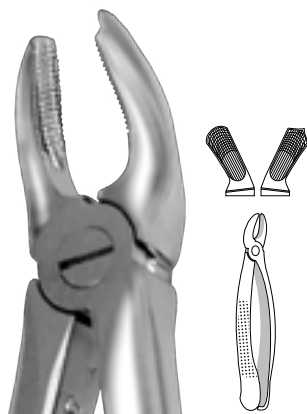

18 European Style Forceps, Serrated
Upper Molars; left.
Standard **FX18**
Matte Finish **FX18E**

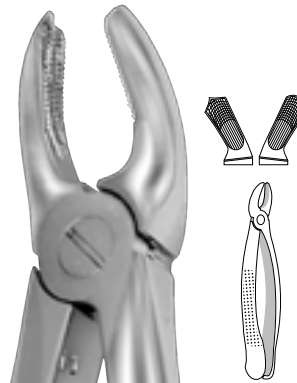

17 European Style Forceps
Upper Molars; right.
Standard **FX17**
Matte Finish **FX17E**

..... Suggested Pair

★ = **Presidential® Forceps** are superbly constructed from forged stainless steel, meticulously crafted and finished with a precision hinge. All HuFriedyGroup Presidential Forceps carry a lifetime warranty against defects in material and workmanship.



Upper and Lower Anteriors

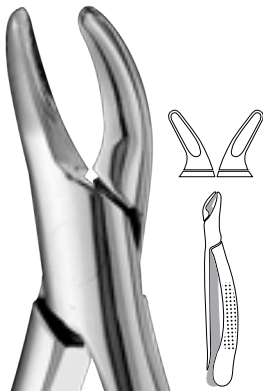

★ **101 Hull Forceps**
Upper & Lower Premolars, and
Deciduous; Universal
F101

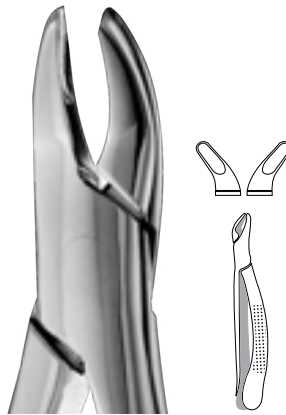

★ **62 Forceps**
Upper & Lower Incisors, Canines,
Premolars, and Deciduous; Universal
F62

Upper Anteriors and Premolars

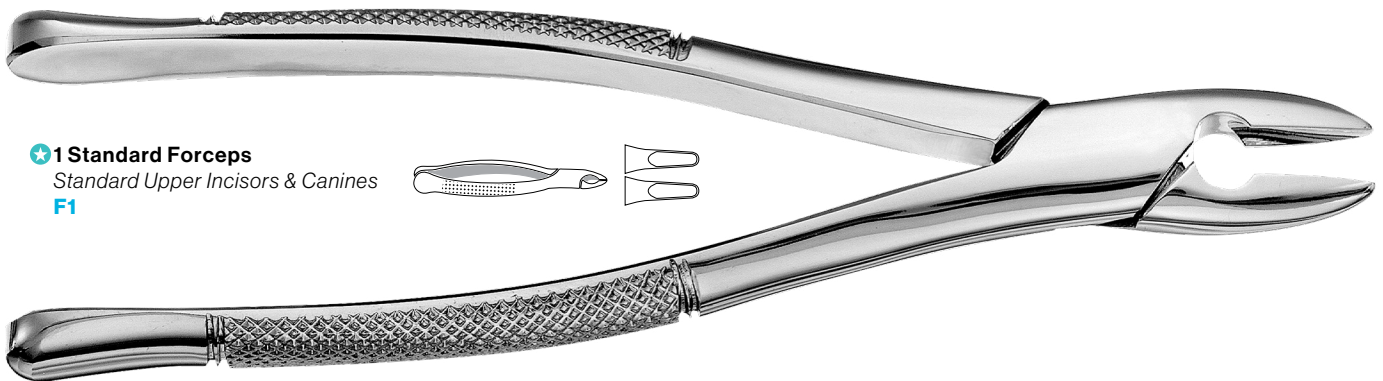

★ **1 Standard Forceps**
Standard Upper Incisors & Canines
F1

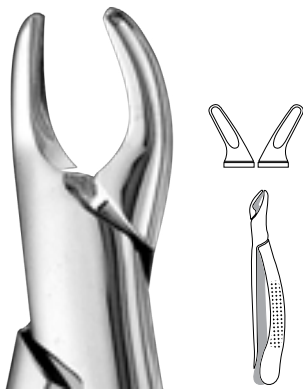
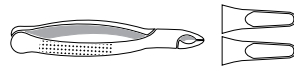

★ **150 Cryer Forceps**
Upper Incisors, Canines, Premolars,
& Roots; Universal
F150

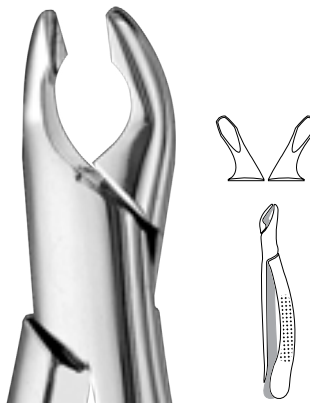

★ **150A Cryer Forceps**
Upper Incisors, Canines &
Premolars; Universal
F150A

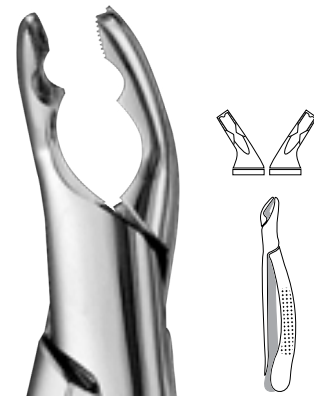

★ **150AS Split Beak Forceps, Serrated**
Upper Incisors, Canines &
Premolars; Universal
F150AS

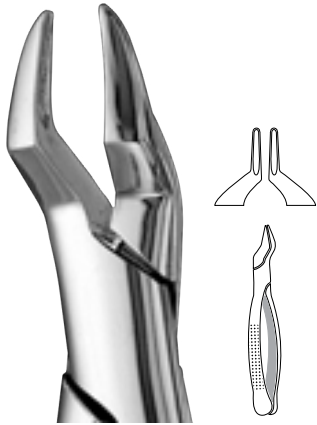

★ **286 Forceps**
Upper Roots, Incisors, Premolars
F286

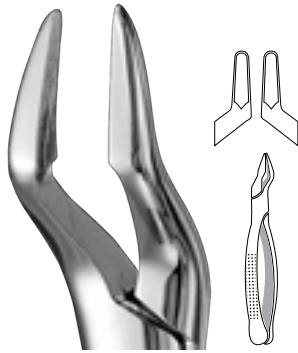

32 Parnly Alveolar Forceps
Upper Canines, Premolars & Molars; Universal.
Sharp edged beaks for breaking the alveolar process and trimming it after extraction.
F32

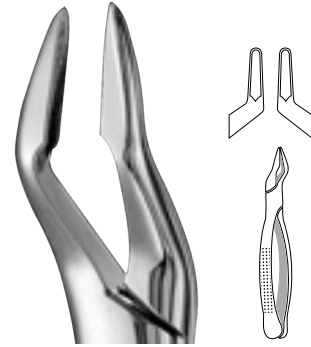

32A Parnly Forceps
Same as No. 32, but with more slender beaks.
F32A

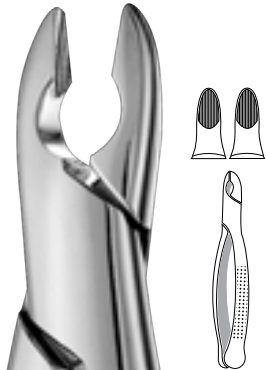

★ **99C Kells Forceps**
Upper Incisors, Canines & Premolars
F99C

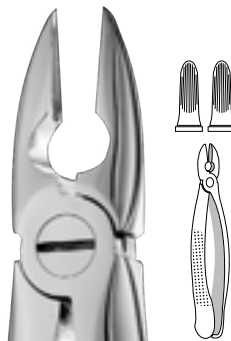

MD-1 Mead Forceps, Serrated
Upper Incisors, Canines, Premolars & Roots
FMD1

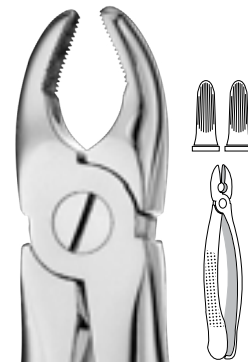

1 European Style Forceps
Upper Anteriors
Standard **FX1**
Matte Finish **FX1E**

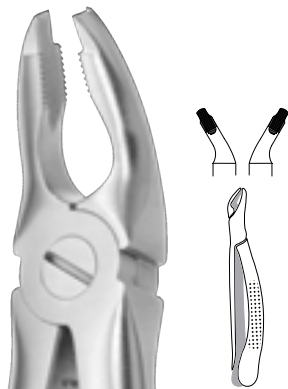

35 European Style Forceps
Upper Incisors, Canines,
Premolars & Roots
Matte Finish **FX35E**

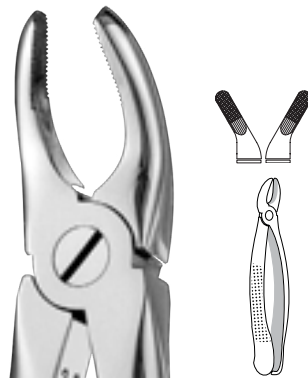

7 European Style Forceps
Upper Premolars
Standard **FX7**
Matte Finish **FX7E**

★ = **Presidential® Forceps** are superbly constructed from forged stainless steel, meticulously crafted and finished with a precision hinge. All HuFriedyGroup Presidential Forceps carry a lifetime warranty against defects in material and workmanship.



European Kinder Style Pedo Forceps

Surgical

**1C European Kinder Style
Pedo Forceps**
Lower Incisors
Matte Finish

FX1CE

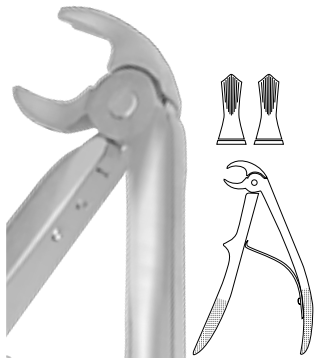
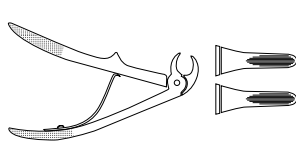
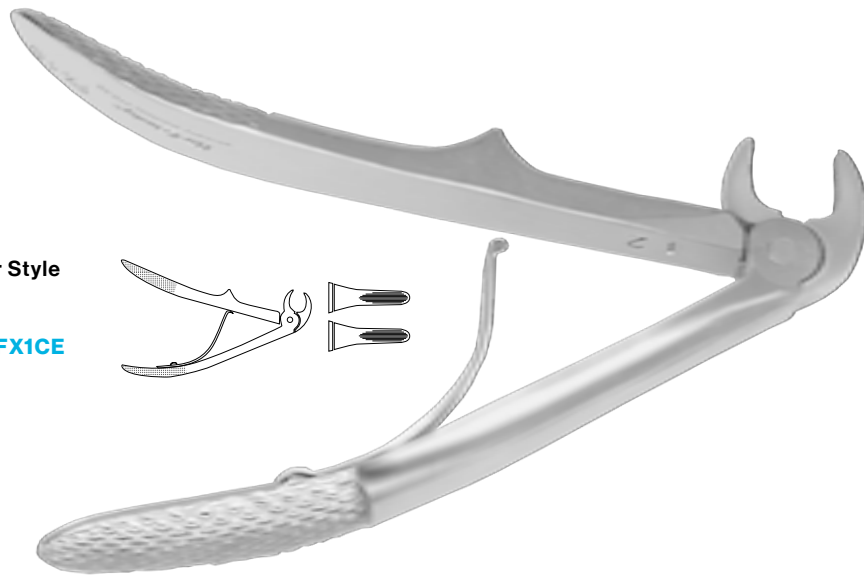

**2C European Kinder Style
Pedo Forceps**
Lower Primary Molars
Matte Finish

FX2CE

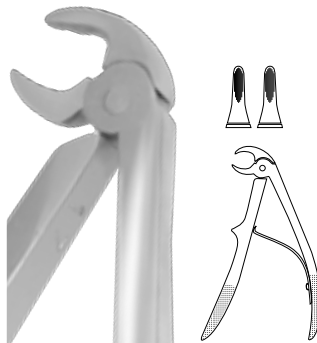

**3C European Kinder Style
Pedo Forceps**
Lower Roots
Matte Finish

FX3CE

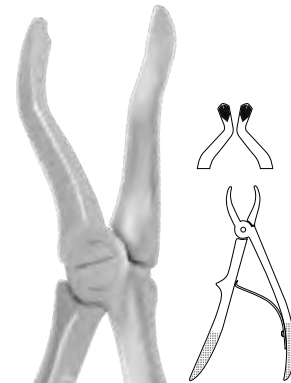

**4C European Kinder Style
Pedo Forceps**
Upper Primary Molars
Matte Finish

FX4CE

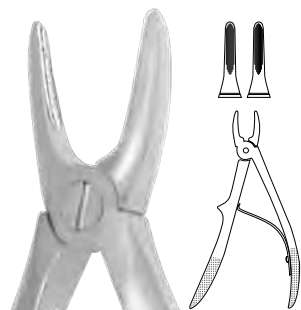

**5C European Kinder Style
Pedo Forceps**
Upper Incisors & Canines
Matte Finish

FX5CE

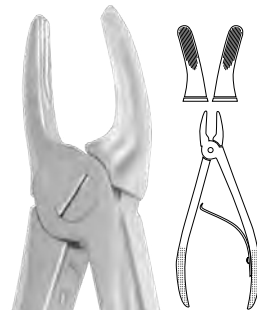

**6C European Kinder Style
Pedo Forceps**
Upper Molars
Matte Finish

FX6CE

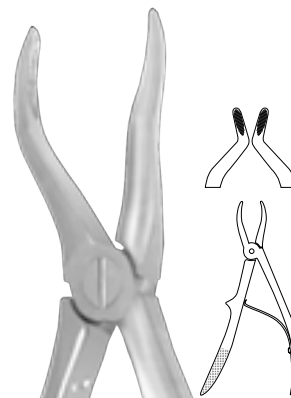

**7C European Kinder Style
Pedo Forceps**
Upper Roots
Matte Finish

FX7CE



Kinder Pedo Forceps

Our Kinder Pediatric Forceps fit easily and comfortably in your hand while being hidden and less visible to patients. Created for small, shallow crowns and conical shaped teeth, the Kinder design requires less force, reducing the risk of tissue damage and broken crowns.

150K Small Pedo Forceps
Upper Primary Incisors & Roots
F150K

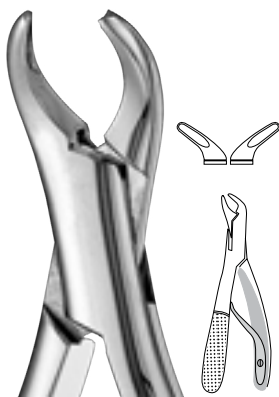
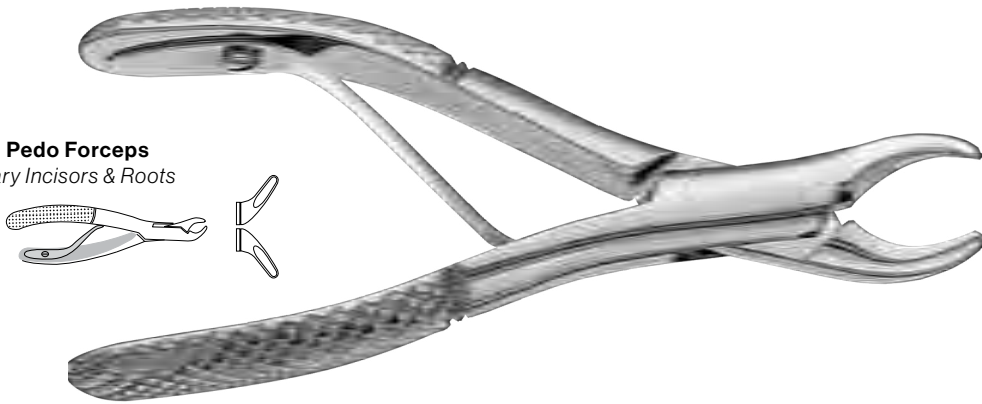

151K Small Pedo Forceps
Lower Primary Incisors & Roots
F151K

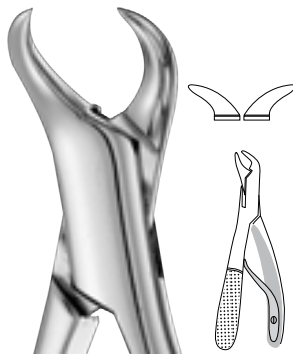

23K Cowhorn Small Pedo Forceps
Lower Primary Molars
F23K



Learn more about our
Pedo Forceps.



Presidential™ Pedo Forceps

Similar to the Standard Pediatric Series, our Presidential™ Forceps are meticulously crafted and finished with a precision hinge.



★ **150S Presidential™ Pedo Forceps**
Upper Primary Teeth & Roots; Universal
F150S

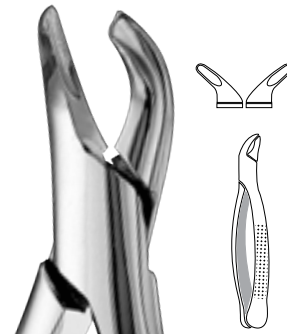

★ **151S Presidential™ Pedo Forceps**
Lower Primary Teeth & Roots; Universal
F151S

Rainbow Presidential™ Pedo Forceps

Our Rainbow Presidential™ Pediatric Forceps feature a unique array of vibrant, rainbow colors to reduce child anxiety and create a more positive patient experience.

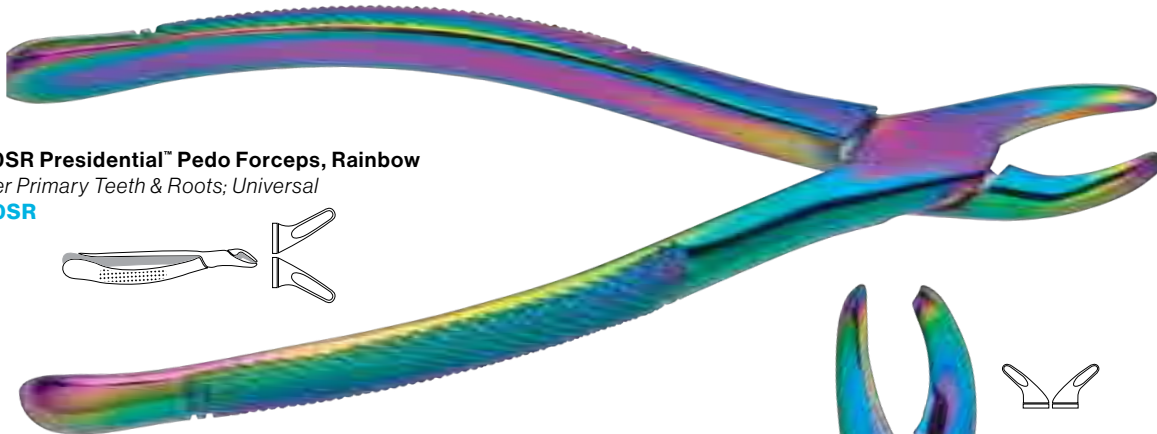

★ **F150SR Presidential™ Pedo Forceps, Rainbow**
Upper Primary Teeth & Roots; Universal
F150SR



★ **F151SR Presidential™ Pedo Forceps, Rainbow**
Lower Primary Teeth & Roots; Universal
F151SR

★ = Presidential® Forceps are superbly constructed from forged stainless steel, meticulously crafted and finished with a precision hinge. All HuFriedyGroup Presidential Forceps carry a lifetime warranty against defects in material and workmanship.

Standard Pedo Forceps

The precise, anatomical design of our Pediatric Forceps assure a firm, accurate grasp of primary tooth and root surfaces for smooth, seamless extractions reducing the risk of complications. Hand-crafted from surgical-grade stainless steel, our Pediatric Forceps ensure superior performance and longevity.

150XAS Split Beak Pedo Forceps, Serrated
Upper Primary; Universal
F150XAS

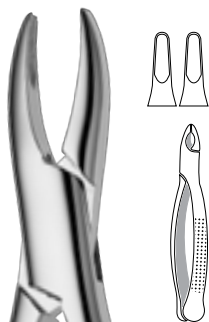

1S Pedo Forceps
Standard Upper Incisors & Canines
F1S

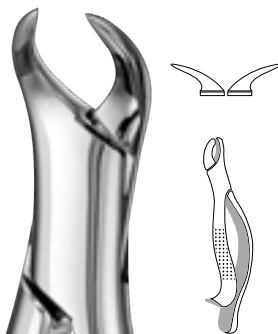

16S Pedo Forceps
Lower Molars
F16S

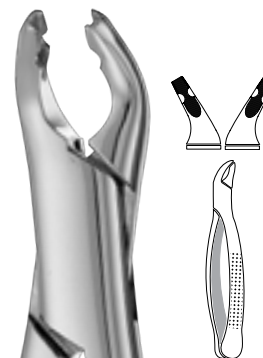

151XAS Split Beak Pedo Forceps, Serrated
Lower Primary; Universal
F151XAS

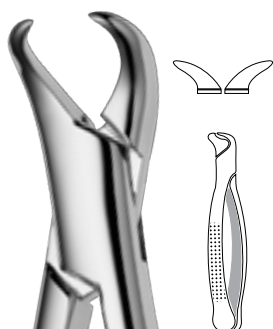

23S Cowhorn Pedo Forceps
1st & 2nd Lower Molars
F23S

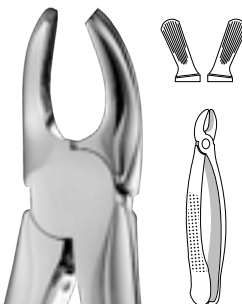

39 Pedo Forceps
1st & 2nd Lower Molars
F39

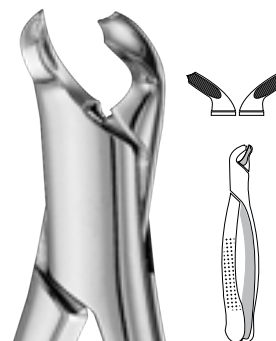

40 Pedo Forceps
Lower Primary Molars
F40



Root Forceps

Surgical

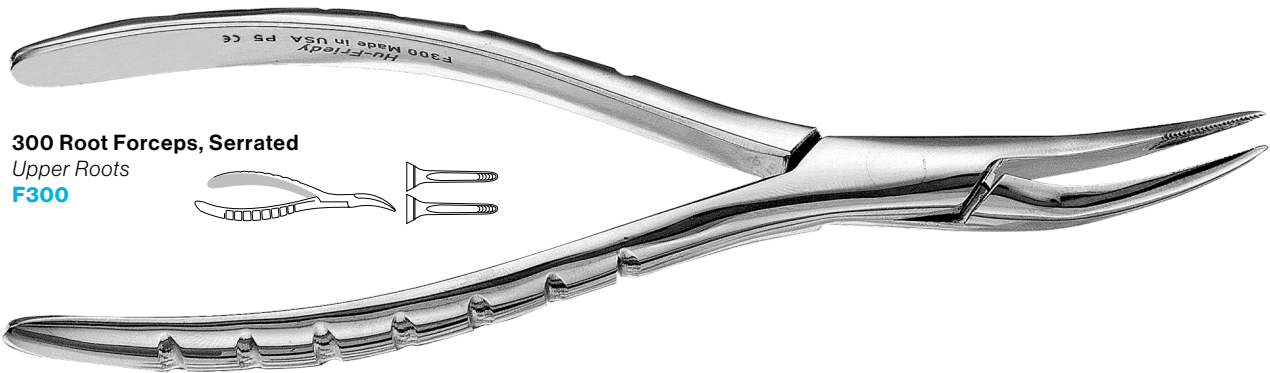

300 Root Forceps, Serrated
Upper Roots
F300

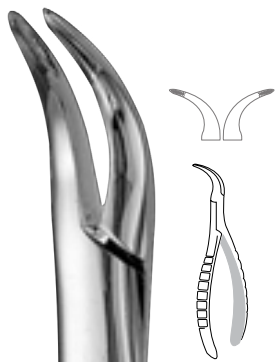

301 Root Forceps, Serrated
Lower Roots
F301

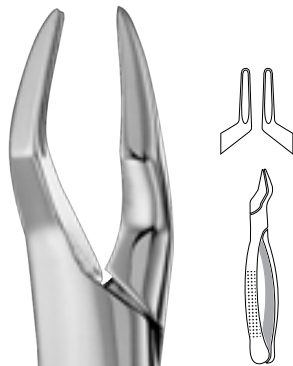

★ **65 Root Forceps**
Upper Roots, Fragments &
Overlapping Incisors
F65

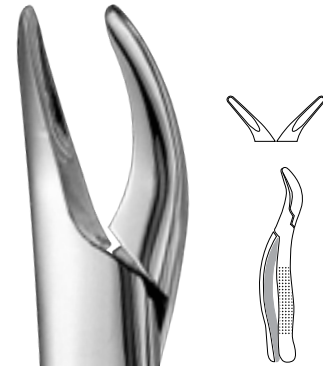

★ **69 Tomes Root Forceps**
Upper & Lower Fragments & Roots
F69

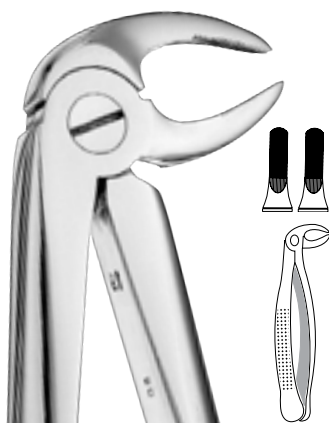

**33 European Style
Root Forceps, Serrated**
Lower Roots
FX33

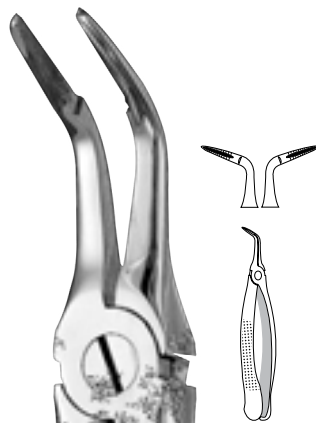

46L Root Forceps, Serrated
Lower Roots
Standard **FX46L**
Matte Finish **FX46LE**

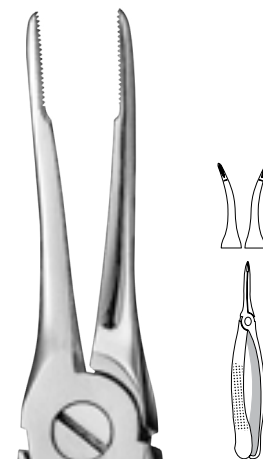

49 Root Forceps, Serrated
Upper Roots
Standard **FX49**
Matte Finish **FX49E**

★ = **Presidential® Forceps** are superbly constructed from forged stainless steel, meticulously crafted and finished with a precision hinge. All HuFriedyGroup Presidential Forceps carry a lifetime warranty against defects in material and workmanship.



Learn more about our
Root Forceps.

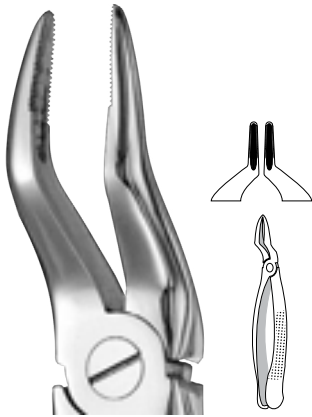

51 European Style Root Forceps, Serrated
Upper Roots
 Standard
 Matte Finish

FX51
FX51E

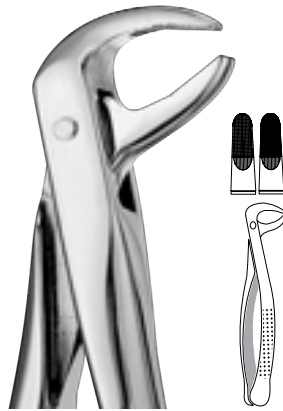

74 European Style Root Forceps, Serrated
Lower Roots
 Standard
 Matte Finish

FX74

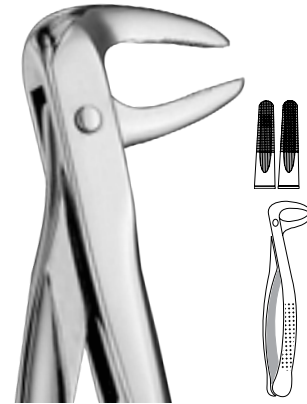

74N European Style Root Forceps, Serrated
Lower Roots
 Standard
 Matte Finish

FX74N

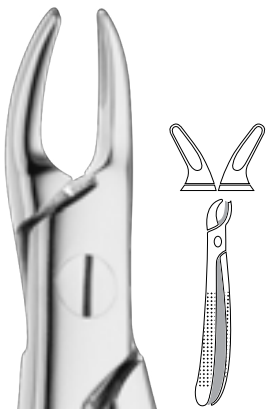

76S Upper Root Forceps, Serrated
FX76S

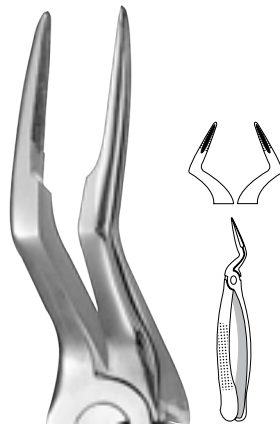

97 Root Forceps, Serrated
Upper Roots
 Standard
 Matte Finish

FX97
FX97E

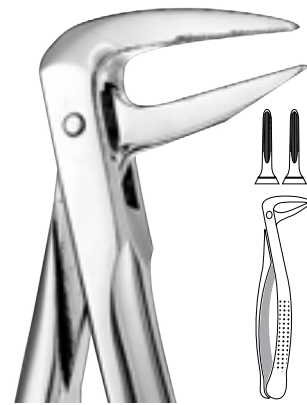

233 Forceps, Serrated
Lower Roots
 Standard
 Matte Finish

FX233
FX233E



Extraction Forceps Reference

Forceps Beaks

The beaks of extraction forceps are anatomically designed to adapt to the tooth at or below the cervical line. Therefore, beaks are either conical, bifurcated, or trifurcated in order to adapt to the tooth or furcations. Many beaks are serrated, which offers additional grasp when extracting teeth.

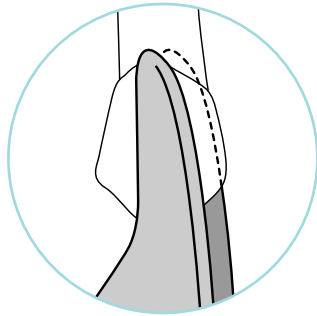

Conical

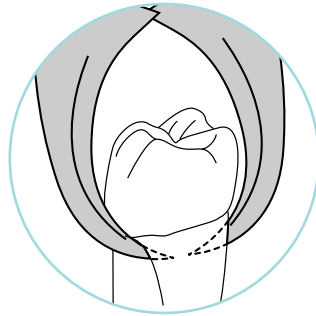

Bifurcated

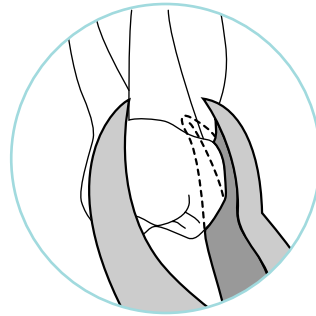

Trifurcated

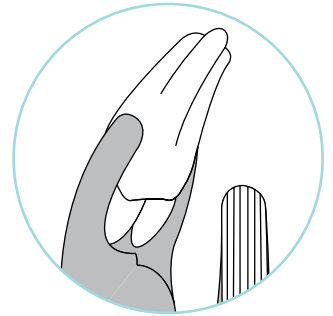

Serrated

Care of HuFriedyGroup Forceps

To maintain proper function and appearance, the following points should be adhered to:

- Clean and sterilize in an open position.
- Clean and thoroughly dry forceps before wrapping for sterilization.

Important

- Lubricate with Instrument Lubricant after cleaning and before sterilization to ensure smooth working action.
- Use ShineRenew wipes to correct hard-to-operate forceps. Rust spots or sediment can be wiped off, as they do not penetrate the surface.
- Do not allow forceps to remain in water or steam moisture for long periods.
- Keep forceps away from strong mineral acids and fumes.

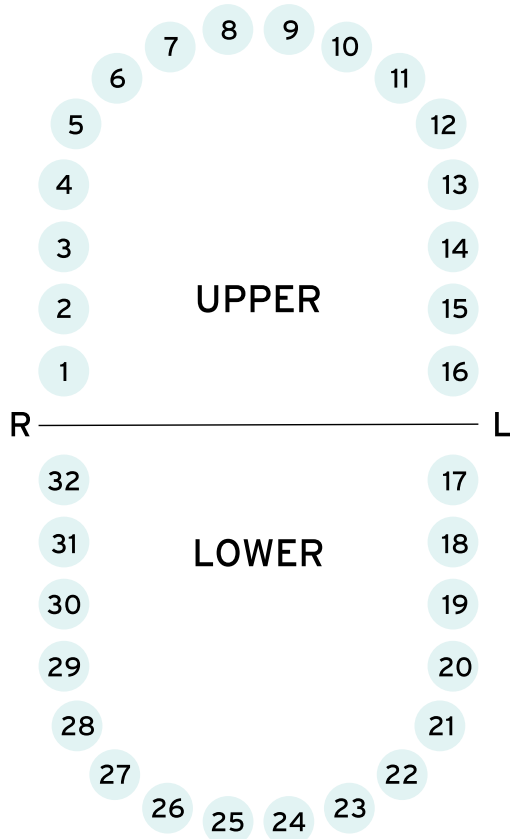

Find Your Forceps

Unsure of which Forceps to use? Use our Find Your Forceps online tool to easily determine which Forceps are used on any given tooth.



Find Your Optimal Extraction Forceps.

Upper Forceps	Incisors	Canines	Premolars	1st Molars	2nd Molars	3rd Molars	Roots	Pediatric
F1XSD	*							
FAF1XSD	*							
F35XSD		*	*					
FAF35XSD		*	*					
FX44XSD							*	
FX51XSD							*	
F67XSD				*	*	*		
F150IS	*	*	*	*	*	*	*	
F1IS	*	*						
F69IS							*	
F53LIS - LEFT				*	*			
F53RIS - RIGHT				*	*			
F88LIS - LEFT				*	*			
F88RIS - RIGHT				*	*			
FAF150IS	*	*	*	*	*	*	*	
FAF1IS	*	*						
FAF1	*	*						
FAF150	*	*	*	*	*	*	*	
FAFX67A				*	*	*		
F1XS	*							
F35XS		*	*					
F67XS				*	*	*		
FAF1XS	*							
FAF35XS		*	*					
FX44XS						*	*	
FX51XS							*	
F10S				*	*	*		
F18L - LEFT				*	*			
F18R - RIGHT				*	*			
F210H						*		
F53L - LEFT				*	*			
F53R - RIGHT				*	*			
F210S						*		
F89				*	*	*		
F90				*	*	*		
FMD2	*	*	*	*	*	*	*	
F88L - LEFT				*	*			
F88R - RIGHT				*	*			
FX67A						*		
FX18				*	*	*		
FX18E				*	*	*		
FX17				*	*	*		
FX17E				*	*	*		
F101	*	*	*	*	*	*		
F62	*	*	*					
F1	*	*						
F150	*	*	*				*	
F150A	*	*	*					
F150AS	*	*	*					
F286	*	*	*				*	
F32		*	*	*	*	*		
F32A		*	*	*	*	*		
F99C	*	*	*					
FMD1	*	*	*				*	
FX1	*	*						
FX1E	*	*						
FX35E	*	*	*				*	
FX7			*					
FX7E			*					
FX4CE				*	*		*	*
FX5CE	*	*					*	*
FX6CE				*	*	*	*	*
FX7CE				*	*	*	*	*
F150K	*						*	*
F150S	*	*	*				*	*
F150SR	*	*	*				*	*
F150XAS	*	*	*	*	*	*	*	*
F1S	*	*						*
F300							*	
F65	*						*	
F69							*	
FX49							*	
FX49E							*	
FX51							*	
FX51E							*	
FX76S							*	
FX97							*	
FX97E							*	

Lower Forceps	Incisors	Canines	Premolars	1st Molars	2nd Molars	3rd Molars	Roots	Pediatric
F13XSD			*					
F21XSD				*	*			
F36XSD	*							
FAF36XSD	*		*					
FX45XSD							*	
F73XSD				*	*	*	*	
FX79XSD				*	*	*	*	
F151IS	*	*	*	*	*	*	*	
F222IS				*	*	*	*	
F23IS				*	*	*	*	
F69IS							*	
FAF151IS	*	*	*	*	*	*	*	
FAF222IS				*	*	*	*	
FAF 151	*	*	*	*	*	*	*	
FAF222				*	*	*	*	
FAFX74N	*	*						
F13XS			*					
F21XS				*	*			
F23XS				*	*	*		
F36XS	*							
FAF36XS	*		*					
FX45XS							*	
FX73XS				*	*	*	*	
FX79XS				*	*	*	*	
F151A	*	*	*				*	
FX13E			*					
FX13			*					
F151AS	*	*	*				*	
F203	*	*	*				*	
FMD3	*						*	
F16				*	*			
F16M				*	*			
F17				*	*			
F217				*	*			
F222						*		
F23				*	*	*	*	
F3FS				*	*	*	*	
FMD4				*	*	*	*	
FX22				*	*	*	*	
FX22E				*	*	*	*	
FX73				*	*	*	*	
FX79						*	*	
FX79E						*	*	
F151	*	*	*				*	
F101	*	*	*	*	*	*	*	
F62	*	*	*					
FX1CE	*							*
FX2CE				*	*			*
FX3CE							*	*
F151K	*						*	*
F23K				*	*	*	*	*
F151S	*	*	*				*	*
F151SR	*	*	*				*	*
F16S				*	*	*	*	*
F151XAS	*	*	*	*	*	*	*	*
F23S				*	*	*	*	*
F39				*	*	*	*	*
F40				*	*	*	*	*
F301							*	*
F69							*	*
FX33							*	*
FX46L							*	*
FX46LE							*	*
FX74							*	*
FX74N							*	*
FX233							*	*
FX233E							*	*



Gauze Packers

Our Gauze Packer is a stainless steel instrument used to pack gauze at the surgical site.



Gauze Packer	
#6	GPHF6
#2	GPHF

Grafting Instruments

Grafting Instruments are meticulously handcrafted with consistent and precise dimensions using the finest grade stainless steel, ensuring easy transport and condensation of graft material at the surgical site.



Learn more about our [Grafting Instruments](#).



Allen Membrane Measurement Card
ALLENCARD



Immunity Steel™ Cup
MCUPE



Dr. Jovanovic Bone Scoop

5 mm **BSJ05**

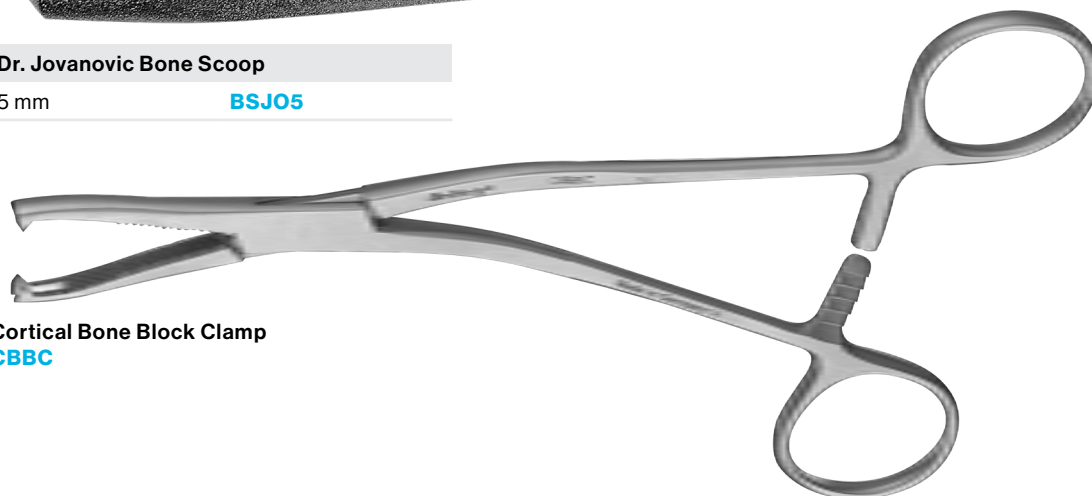

Cortical Bone Block Clamp
CBBC



Labanca Bone Curette

7 mm

#6

CSLABANCA6



Palti Bone Graft Scoop

Black Line

IMP6522X

#6

IMP65226

#10

IMP6522



Palti Sinus Lift Instrument, Small

#6

IMP6523S6

#10

IMP6523S



Palti Sinus Lift Instrument

#6

IMP6524S6

#10

IMP6524S

- Refer to page A709 for a detailed listing of the Bone Grafting Kit, Black Line (IMNBGKITX) and Bone Grafting Kit (IMBGKIT).

Membrane Placement



Membrane Placement Instrument

Black Line

PMPIX

#6

PMPI6

#6, Short

PMPIS6

#2

PMPI

#2, Short

PMPIS

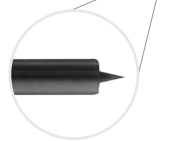

Euwe Membrane Placement Instrument

#6

PMPIE

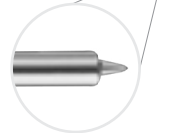

Modified PMPI Membrane Placement Inst.

#6

PMP7002

Chu Prosthetic Placement Instrument

PPIS



Pluggers / Condensers



Grisdale Bone Condenser
8-11-13-15-18 mm

Black Line	PLGGR1X
#6	PLGGR1
#6, Short	PLGGR1S6



Jovanovic Plugger, DE
3 mm

Black Line	PLGJO/4X
#6	PLGJO/46
#522	PLGJO/4



Jovanovic Bone Condenser/Periosteal
3 mm

#6	PLGJO/56
----	-----------------



Bone Packer DE
6-8 mm

	BPACK
--	--------------



Labanca Plugger

Black Line	PLGLABANCX
#6	PLGLABANC6



Rompen Plugger, Buccal/Lingual

Black Line	PLGROMP1X
------------	------------------

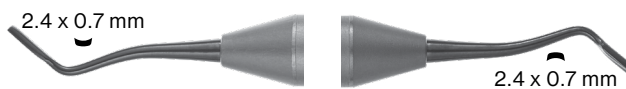

Rompen Plugger, Mesial/Distal

Black Line	PLGROMP2X
------------	------------------



Tahmaseb Sinus Lift/Bone Plugger
3 mm

#6	PLGTAHM
----	----------------



Euwe Bone Scoop/Plugger
#6, Short

	CSEUWES6
--	-----------------



Hemostats

Designed to optimize clinical efficiencies as a multipurpose instrument, our Hemostats are used for clamping off blood vessels, removing small root tips and grasping loose objects.



Learn more about our [Hemostats](#).



#1 Kelly Hemostat, Straight
5" **H1**

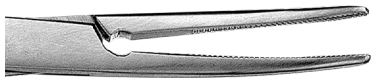

#2 Kelly Hemostat, Curved
5" **H2**



#3 Mosquito Hemostat, Curved
4" **H3**



#4 Mosquito Hemostat, Straight
4" **H4**



#5 1x2 Hemostat, Straight
5" **H5**



Adson Hemostat, Curved
7.5" **HAC**

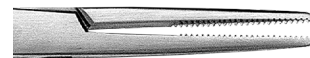

Adson Hemostat, Straight
7.5" **HAS**



Hartmann Hemostat, Curved
4" **HHC**



Hartmann Hemostat, Straight
4" **HHS**



Kocher Hemostat, Curved
5.5" **HKC**



Kelly-Rankin Hemostat, Curved
6.25" **HKRC**



Kelly-Rankin Hemostat, Straight
6.5" **HKRS**

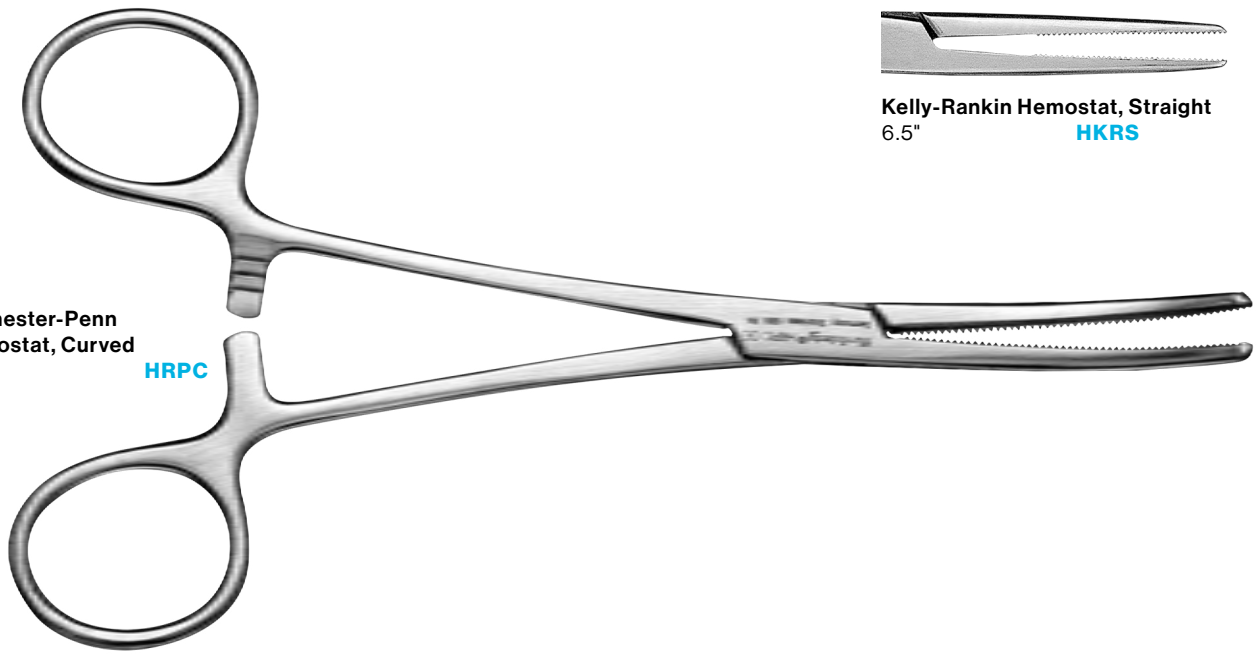

Rochester-Penn
Hemostat, Curved
6" **HRPC**



Implantology

We provide an extensive line of implantology instrumentation including sinus lift instruments, bone condensers, bone syringes, surgical curettes, periosteals, tissue pliers, bone placement instruments and rongeurs. Many were developed in conjunction with our Key Opinion Leaders and global educators.

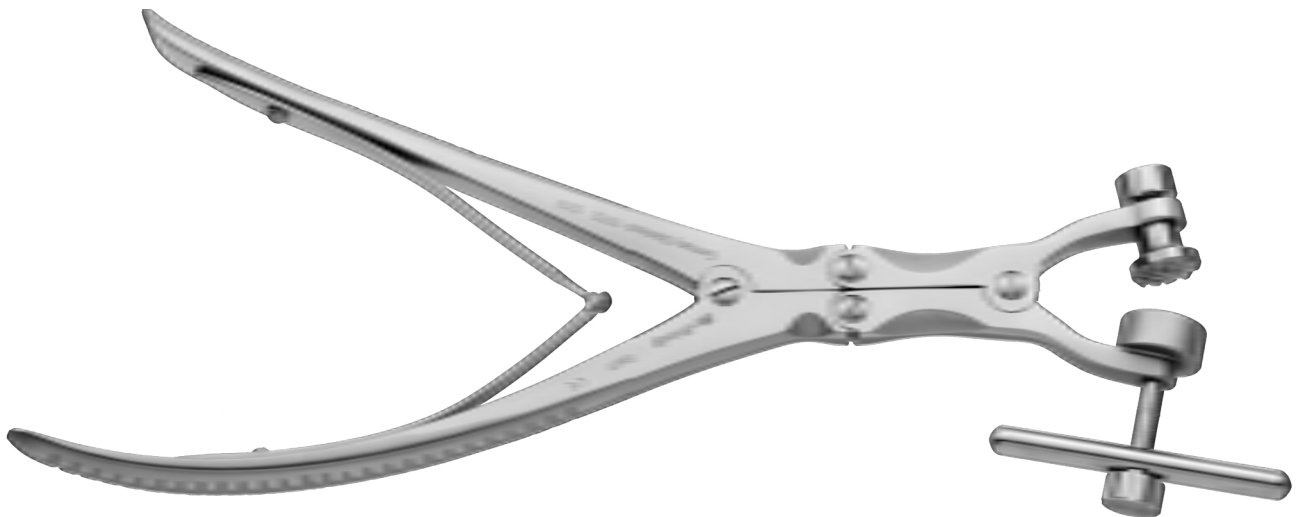

Giles de Quincey Bone Mill	
Titanium	BMTI
Stainless-Steel	BMSS

Bone Mill Replacement Grinders	
<i>Includes two grinders</i>	
Titanium	BMGRINDTI
Stainless-Steel	BMGRINDSS



Watch the **Giles de Quincey Bone Mill** in use.

Bone Mill Set Screws, & Milling Handle	
<i>Includes two set screws and one milling handle</i>	
BMSCREWSET	



Bone Rasp

RASP



Tabanella Micro Bone Condenser

TABANELLA1



Tabanella Papilla Micro Elevator

TABANELLA2

Sinus Lift Instruments

Featuring a wide range of sinus lift instrument designs, we offer a variety of size, working-end and angulation options to provide optimal access to separate and reflect the Schneiderian membrane from the maxillary bone and to elevate the membrane during lateral sinus lift procedures.



300 Sinus Lift Instrument

Black Line **IMP300X**

#6 **IMP3006**

#6, Short **IMP300S6**



Simion Sinus Lift Instrument

#6 **IMP300SIM**



725 Implant Instrument	
#6	IMP6343S6
#522	IMP6343S

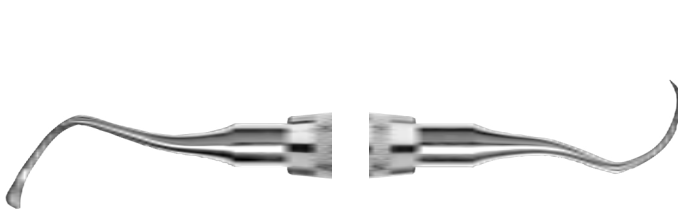

709 Implant Instrument	
#6	IMP6344S6
#522	IMP6344S

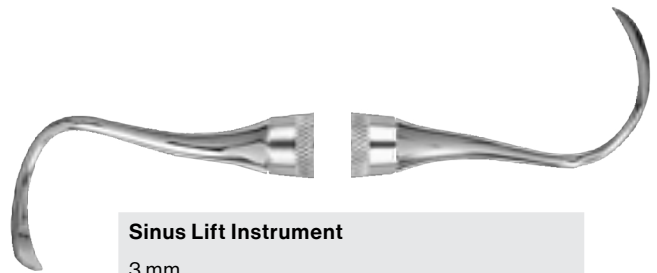

Sinus Lift Instrument	
3 mm	
#6	IMP63456
#6, Short	IMP6345S6
#522	IMP6345S
#10	IMP6345-71



7 Implant Instrument	
#6	IMP6346S6
#522	IMP6346S



914 Implant Instrument	
#6	IMP6347S6
#522	IMP6347S

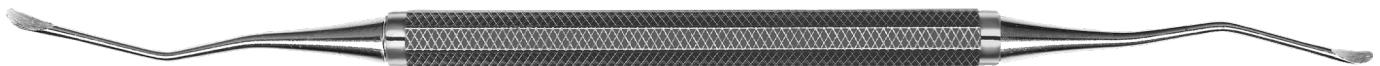

912 Implant Instrument	
#522	IMP6348S



Kramer-Nevins Acute Sinus Lift Instrument, Large/Small

Black Line	IMP6577SCX
#6	IMP6577SC6
#10, Short	IMP6577SC

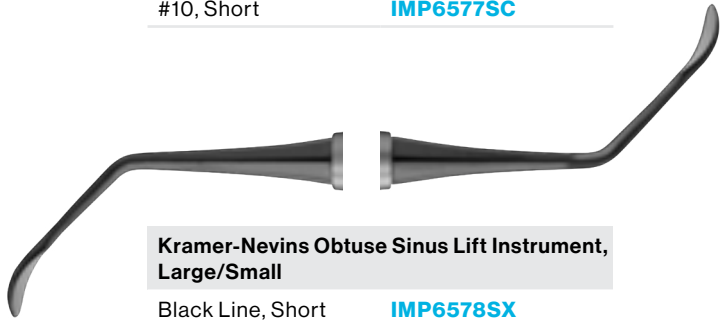

Kramer-Nevins Obtuse Sinus Lift Instrument, Large/Small

Black Line, Short	IMP6578SX
#6	IMP65786
#2	IMP6578

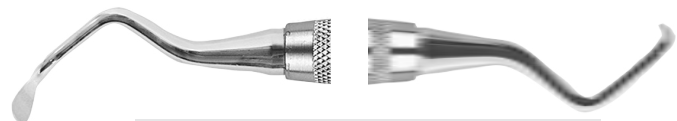

Sinus Lift Instrument

#6	IMP7044K
----	--------------------------



1 Rompen Sinus Lift Instrument

#6	IMPROMP16
----	---------------------------



2 Rompen Sinus Lift Instrument

#6	IMPROMP26
----	---------------------------



3 Rompen Sinus Lift Instrument

#6	IMPROMP36
----	---------------------------



Dr. Rompen Sinus Spatula

	SSPR1
--	-----------------------



Jovanovic Implant Instrument

#6	IMPJO66
#522	IMPJO6



1 Sinus Lift Instrument

3.5 mm	
#6	IMPSIM16
#10, Short	IMPSIM1

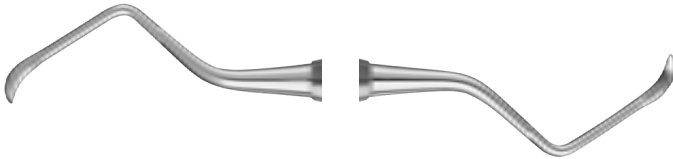

Tarnow-Eskow Sinus Lift Instrument

#6	IMPSTE1/26
----	-------------------

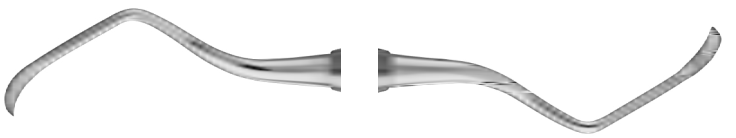

1 Urban Sinus Lift Instrument

#6	IMPURBAN16
#6, Short	IMPURBA1S6

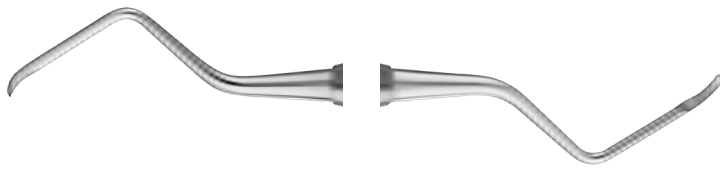

2 Urban Sinus Lift Instrument

#6	IMPURBAN26
#6, Short	IMPURBA2S6



3 Urban Sinus Lift Instrument

#6	IMPURBAN36
----	-------------------



Urban Sinus Lift Instrument

#4	IMPURBAN46
----	-------------------



Sinus Lift Instrument SE

#6	PESIM16
#40	PESIM1



Sinus Curette 1	
Black Line	SINC1X
Black Line, Short	SINC1SX
#6	SINC1
#6, Short	SINC1S6



Sinus Curette 2	
Black Line	SINC2X
Black Line, Short	SINC2SX
#6	SINC2
#6, Short	SINC2S6



Learn more about our [Sinus Lift Instruments.](#)

Abutment Instruments

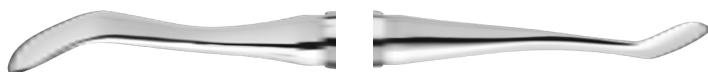

1 Zingheim Periosteal	
#6	IPZ16
#522	IPZ1



3 Zingheim Periosteal	
#6	IPZ36
#522	IPZ3



2 Zingheim Implant Guide	
#6	IPZ26
#522	IPZ2

Implant Probes

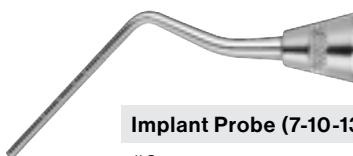

Implant Probe (7-10-13-15-18)	
#6	IMPSIM36

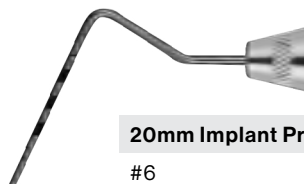

20mm Implant Probe (8-10-12-14-16-18-20)	
#6	PCP65006
#30	PCP6500



Knives

From spear-shaped blades for excising interproximal tissue, to oval designs for initial gingivectomy incisions, we offer a wide range of periodontal knives for various surgical and periodontal procedures.



Learn more about our [Periodontal Knives](#).



3/4 Buck DE Knife
#6 [KB3/46](#)

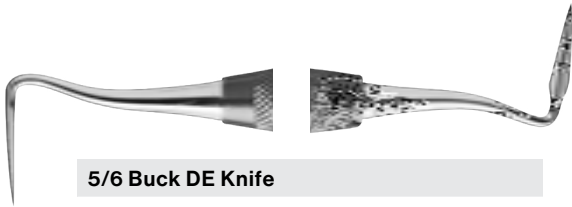

5/6 Buck DE Knife
#6 [KB5/66](#)

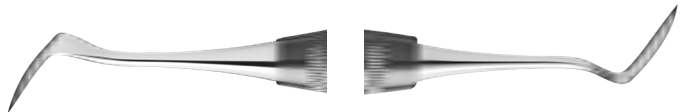

CK-3 Crane-Kaplan Knife DE
#6 [KCK36](#)
#2 [KCK3](#)

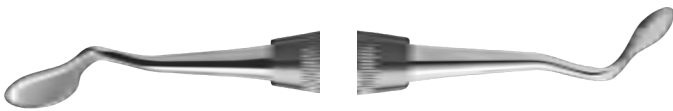

GF-7 Goldman-Fox Knife DE
#6 [KGF76](#)

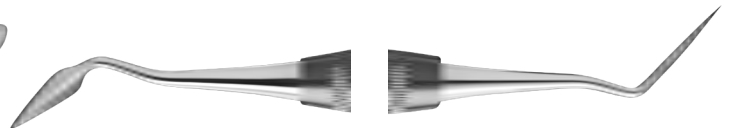

GF-8 Goldman-Fox Knife DE
#6 [KGF86](#)



GF-9 Goldman-Fox Knife DE
#6 [KGF96](#)



GF-11 Goldman-Fox Knife DE
Black Line [KGF11X](#)
#6 [KGF116](#)



15/16 Kirkland Knife DE	
Black Line	KK15/16X
Black Line, Short	KK15/16SX
#6	KK15/166
#6, Short	KK15/16S6
#9	KK15/169

15K Kirkland Knife SE	
#6	KK156
#24	KK15

16K Kirkland Knife SE	
#6	KK166
#24	KK16



1/2 Orban Knife DE	
Black Line	KO1/2X
#6	KO1/26
#9	KO1/29

1 Orban SE Knife	
#6	KO16
#24	KO1



GDQ Tunneling Knife 1	
Black Line	FQUINCEY1X



GDQ Tunneling Knife 2	
Black Line	FQUINCEY2X



Allen Arrowhead Knife	
Black Line	KO12KP3R4X
#9	KO12KP3R49

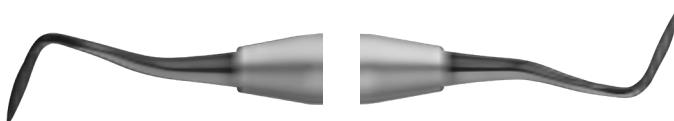

1/2 Allen Orban Knife	
<i>30% thinner than standard Orban Knife</i>	
Black Line	KO12KP03AX
#6	KO12KP03A6
#9	KO12KP03A9

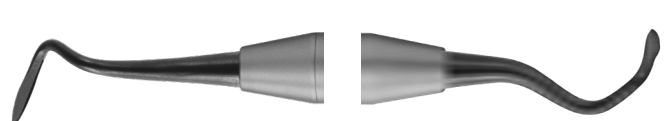

1/2 Allen Modified Orban Knife, Round	
Black Line	KO12KP03RX
#6	KO12KP03AR
#9	KO12KP03R9



Allen End-Cutting Intrasulcular Knife
 Black Line **KPAX**
 #6 **KPA**

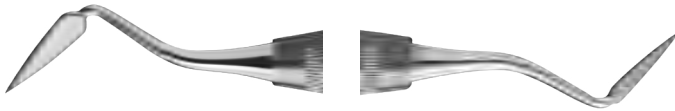

11 Kramer-Nevins Knife DE
 #6 **KKN116**



7 Kramer-Nevins Knife DE
 #6 **KKN76**

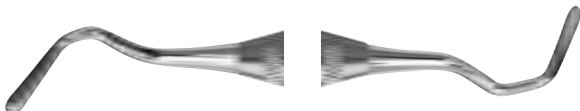

1 Dr. Reddy Knife
 #6 **KRDY1**

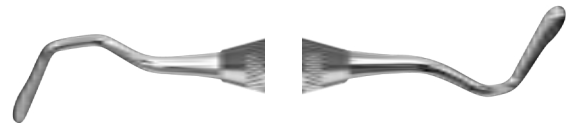

2 Dr. Reddy Knife
 #6 **KRDY2**



1/2 Sanders Knife DE
 #6 **KS1/26**

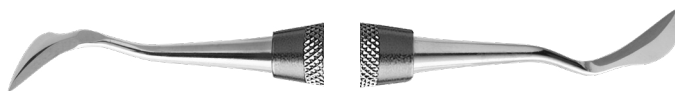

1/2 Solt Gingivectomy Knife DE
 #6 **KSOLT1/26**

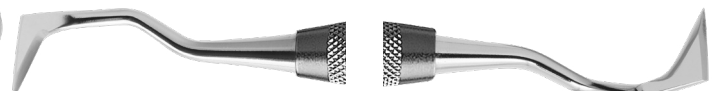

19/20 USC Towner Knife DE
 #6 **KUSC6**



PM Nanos A Perio Knife, Angulated
Smooth **PMNANOAS**



PM Nanos S Perio Knife, Straight
Smooth **PMNANOSS**

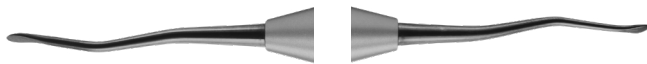

1 Tunneling Knife
Black Line **TKN1X**
Black Line, Short **TKN1SX**
#6 **TKN1**
#6, Short **TKN1S6**
Smooth **TKN1CH**

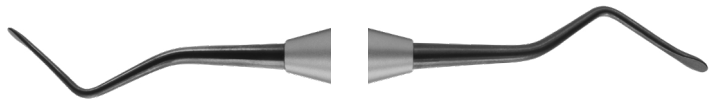

2 Tunneling Knife
Black Line **TKN2X**
Black Line, Short **TKN2SX**
#6 **TKN2**
#6, Short **TKN2S6**
Smooth **TKN2CH**

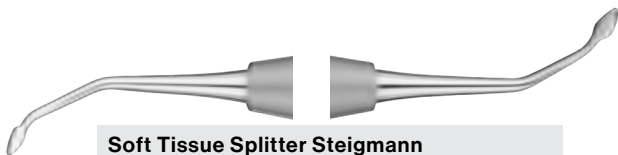

Soft Tissue Splitter Steigmann
Smooth **TKSTEIG**

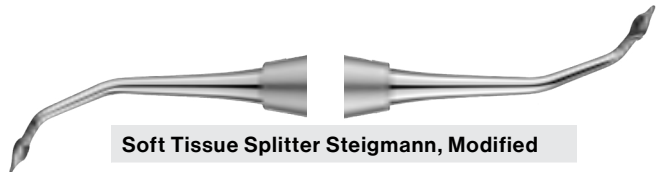

Soft Tissue Splitter Steigmann, Modified
Smooth **TKSTEIG2**



Mallets



Nylon Facing For #1 Mallet

PTNFM1

#1 Mead Immunity Steel™ Mallet

MAL1

Mouth Gags

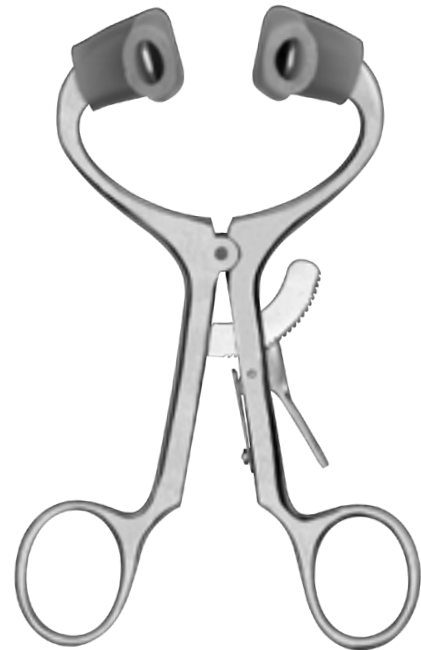

Silicone Replacement Tips

Adult	PTRTA
Child	PTRTC
Infant	PTRTI

Molt Mouth Gag

Adult	MGA
Child	MGC
Infant	MGI

Mouth Props



Mouth Prop, Latex-Free	
Pair of 2	
Small Child	MP48
Child	MP52
Adult	MP54

Needle Holders

Our Perma Sharp™ Needle Holders feature tungsten carbide inserts with a matched diamond-cut pyramidal profile for enhanced longevity, a secure, positive suture needle grasp and reduced risk of cutting the suture material.

 [Learn more about our Needle Holders.](#)

Microsurgical Needle Holders

Microsurgical needle holders have a lock to ensure that the needle is firmly secured. This allows the needle to be guided through coarse gingival tissue with controlled grip pressure.



Castroviejo Microsurgical Needle Holder, Straight
5-0, 6-0, 7-0, 8-0
14 cm **NH5020M**



Castroviejo Microsurgical Needle Holder, Curved
5-0, 6-0, 7-0, 8-0
14 cm **NH5021M**



Cortellini Castroviejo Microsurgical Needle Holder, Straight
Round Handle
5-0, 6-0, 7-0, 8-0, 9-0, 10-0
18 cm **NH5024CORT**



Diamond Dusted Castroviejo Microsurgical Needle Holder, Straight
Round Handle
5-0, 6-0, 7-0, 8-0, 9-0, 10-0
15 cm **NHM-5025R**



Diamond Dusted Castroviejo Microsurgical Needle Holder, Straight
Round Handle
5-0, 6-0, 7-0, 8-0, 9-0
18 cm **NHM-5026R**



Schlee Microsurgical Needle Holder
6-0, 7-0, 8-0
18 cm **NHLSCHLEE**

Castroviejo Microsurgical Needle Holders



Castroviejo Microsurgical Needle Holder
5-0, 6-0, 7-0, 8-0
14 cm **NHCV**
18 cm **NHCV18**



Diamond Dusted Castroviejo Microsurgical Needle Holder, Straight
6-0, 7-0, 8-0
18 cm **NHDCPV**

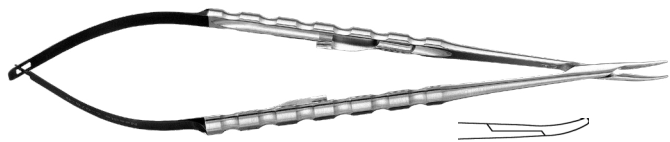

Diamond Dusted Castroviejo Microsurgical Needle Holder, Curved
4-0, 5-0, 6-0
18 cm **NHDCPVN**



Diamond Dusted Castroviejo Microsurgical Needle Holder, Straight
6-0, 7-0, 8-0
18 cm **NHDPV**

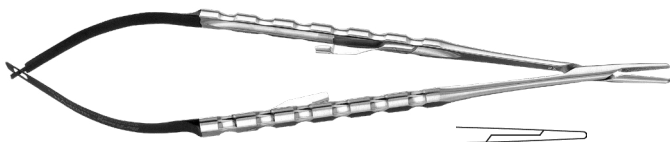

Diamond Dusted Castroviejo Microsurgical Needle Holder, Straight
4-0, 5-0, 6-0
18 cm **NHDPVN**



Castroviejo Microsurgical Needle Holder, Curved
6-0, 7-0, 8-0, 9-0, 10-0, 11-0
13 cm **NHM-5027**



Castroviejo Microsurgical Needle Holder, Straight

6-0, 7-0, 8-0, 9-0, 10-0, 11-0

13 cm

NHM-5028



Swis Perio Microsurgical Needle Holder

5-0, 6-0, 7-0, 8-0, 9-0

18 cm

SPNHDPVN



Titanium Diamond Dusted Castroviejo Microsurgical Needle Holder

6-0, 7-0, 8-0

18 cm

NHTMBH

Perma Sharp™ Castroviejo Needle Holders



Perma Sharp™ Castroviejo Needle Holder, Straight

5-0, 6-0, 7-0, 8-0

14 cm

NH5020



Perma Sharp™ Castroviejo Needle Holder, Round

Round Handle

5-0, 6-0, 7-0, 8-0

14 cm

NH5020R



Perma Sharp™ Castroviejo Needle Holder, Curved

5-0, 6-0, 7-0, 8-0

14 cm

NH5021



Perma Sharp™ Castroviejo Needle Holder, Curved

Round Handle

5-0, 6-0, 7-0

14 cm

NH5021RC



Perma Sharp™ Castroviejo Needle Holder, Flat

5-0, 6-0, 7-0, 8-0, 9-0, 10-0

18 cm

NH5024



Perma Sharp™ Castroviejo Needle Holder, Round

Round Handle

5-0, 6-0, 7-0, 8-0, 9-0, 10-0

18 cm

NH5024R



Perma Sharp™ Castroviejo Needle Holder, Curved

Round Handle
5-0, 6-0, 7-0, 8-0, 9-0, 10-0

18 cm

NH5024RC



Simion Perma Sharp™ Castroviejo Needle Holder

3-0, 4-0, 5-0, 6-0

18 cm

NH5024SIM

Perma Sharp™ Needle Holders

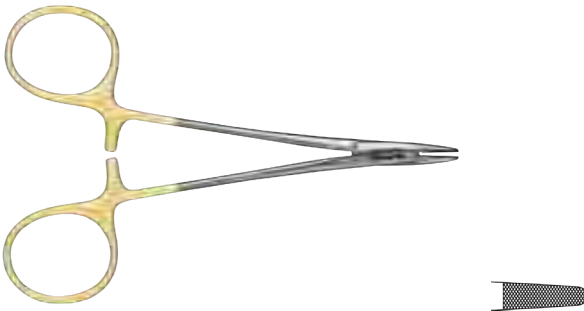

Derf Perma Sharp™ Needle Holder

*3-0, 4-0, 5-0

11.5 cm

NH5032



Perma Sharp™ Hegar-Baumgartner Needle Holder

*1-0, 2-0, 3-0, 4-0

14 cm

NH5034

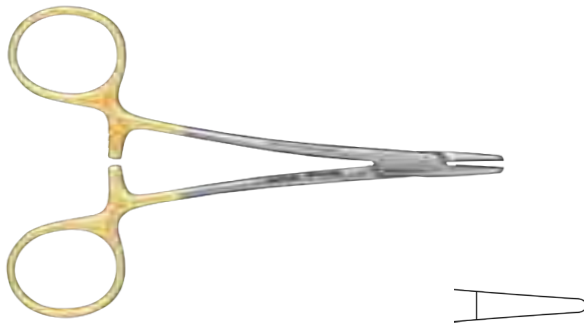

Halsey Perma Sharp™ Needle Holder, Smooth

*8-0, 9-0, 10-0

13 cm

NH5036



Halsey Perma Sharp™ Needle Holder, Serrated

*3-0, 4-0, 5-0, 6-0

13 cm

NH5037

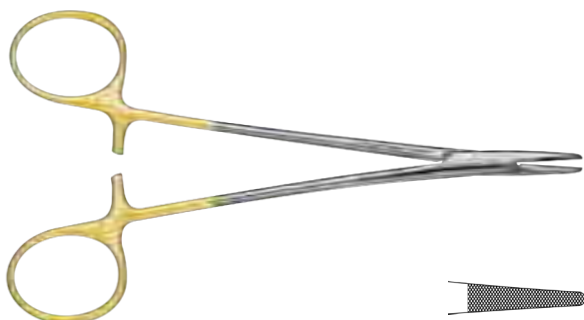

Crile-Wood Perma Sharp™ Needle Holder

*3-0, 4-0, 5-0, 6-0

15 cm

NH5038

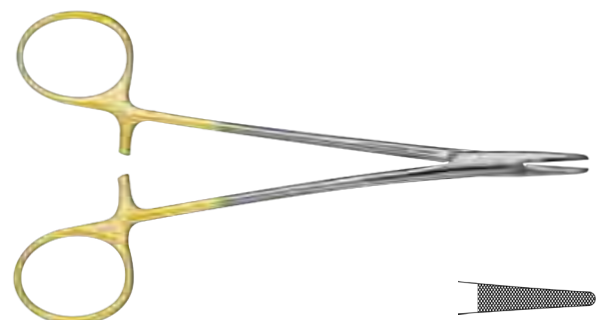

Crile-Wood Perma Sharp™ Needle Holder, Left Handed

*3-0, 4-0, 5-0, 6-0

15 cm

NH5038L

*Recommended suture sizes

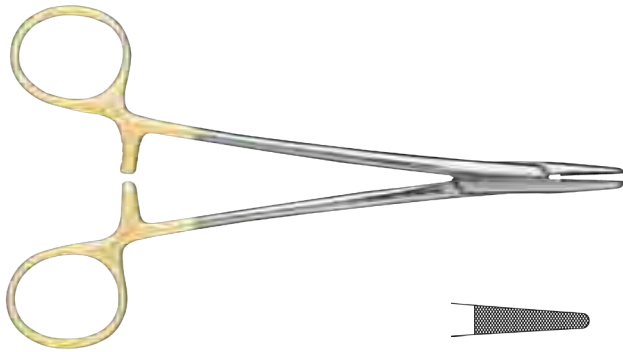

Mayo-Hegar Perma Sharp™ Needle Holder

*1-0, 2-0, 3-0, 4-0

16 cm

NH5042

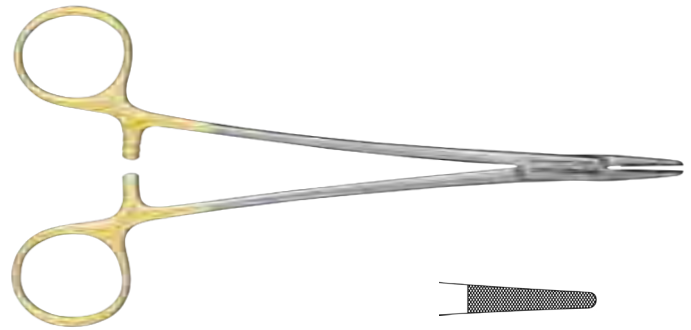

Mayo-Hegar Perma Sharp™ Needle Holder

*1-0, 2-0, 3-0, 4-0

18 cm

NH5044

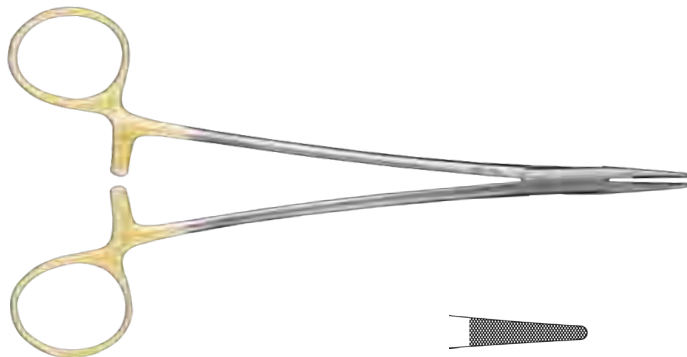

DeBakey Perma Sharp™ Needle Holder

*4-0, 5-0, 6-0

18 cm

NH5046

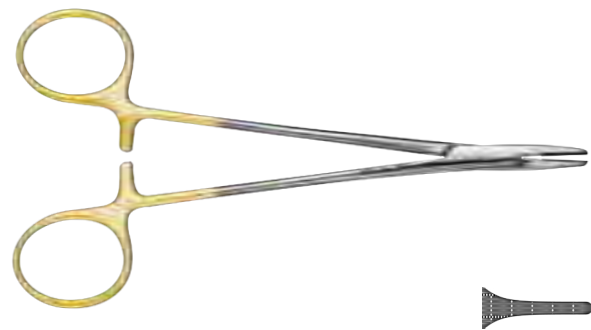

HMT Perma Sharp™ Needle Holder

*4-0, 5-0, 6-0

15 cm

NH5050

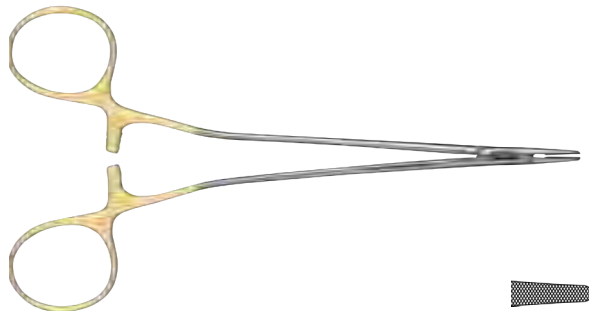

Fine Swedish Pattern Perma Sharp™ Needle Holder

*5-0, 6-0, 7-0, 8-0

15 cm

NH5052

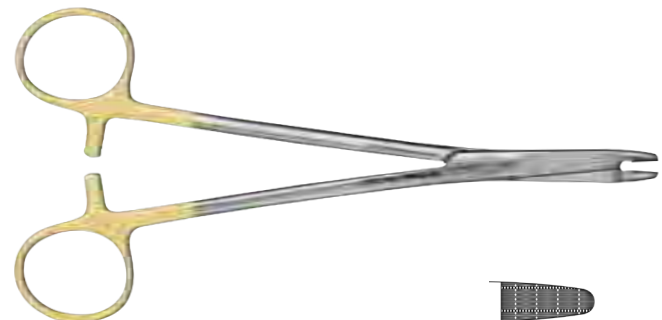

Olsen-Hegar Perma Sharp™ Needle Holder

*3-0, 4-0, 5-0, 6-0

17 cm

NH5068



Mathieu-Kocher Perma Sharp™ Needle Holder

*1-0, 2-0, 3-0, 4-0

14 cm

NH5074E



Mathieu-Kocher Perma Sharp™ Needle Holder

*1-0, 2-0, 3-0, 4-0

14 cm

NH5074

*Recommended suture sizes

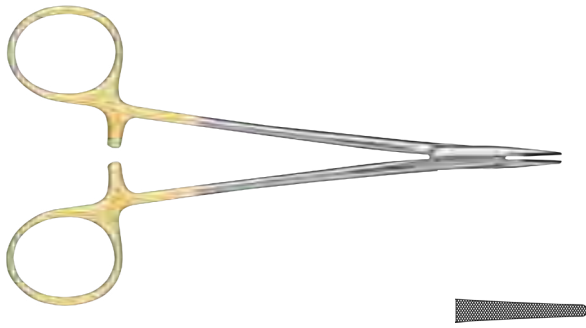

Micro-Vascular Pattern Perma Sharp™ Needle Holder
*6-0, 7-0, 8-0
15 cm **NH5082**

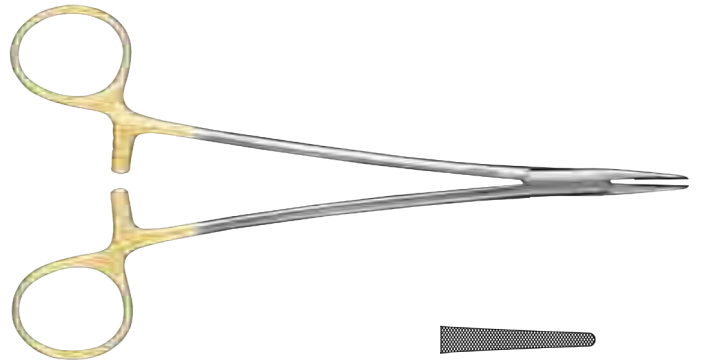

Micro-Vascular Pattern Perma Sharp™ Needle Holder
*6-0, 7-0, 8-0
18 cm **NH5084**



Mini-Ryder Perma Sharp™ Needle Holder
*8-0, 9-0, 10-0
15 cm **NH5092**



Gillies Fine Needle Holder
*4-0, 5-0, 6-0
15 cm **NHGILFINE**

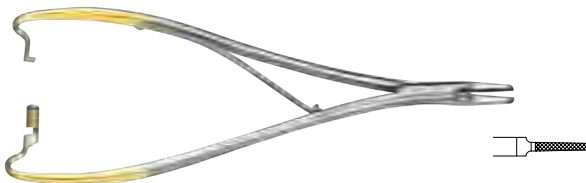

Lichtenberg Perma Sharp™ Needle Holder
*3-0, 4-0, 5-0, 6-0
20 cm **NHLBPSB**

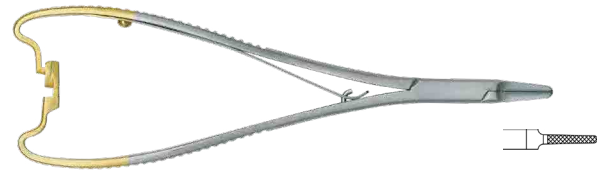

Lichtenberg Perma Sharp™ Needle Holder
*3-0, 4-0, 5-0
17 cm **NHLBPSE**

General Needle Holders

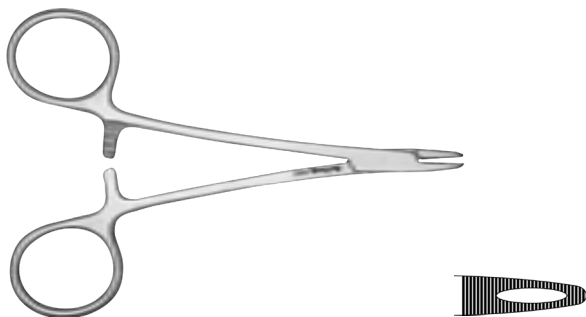

Collier Needle Holder
3-0, 4-0, 5-0, 6-0
12 cm **NHC**

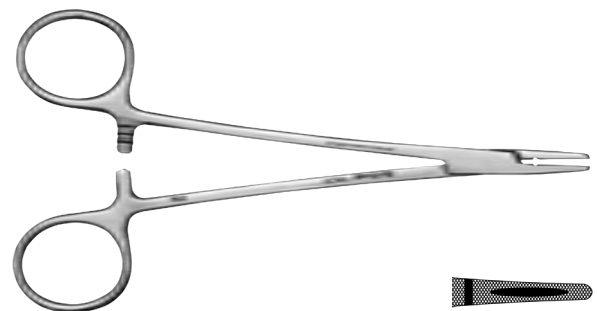

Crile-Wood Needle Holder
3-0, 4-0, 5-0, 6-0
15 cm **NHCW**

*Recommended suture sizes

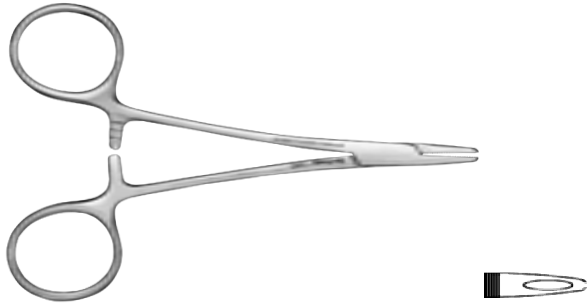

Derf Needle Holder
3-0, 4-0, 5-0, 6-0
12 cm **NHD**

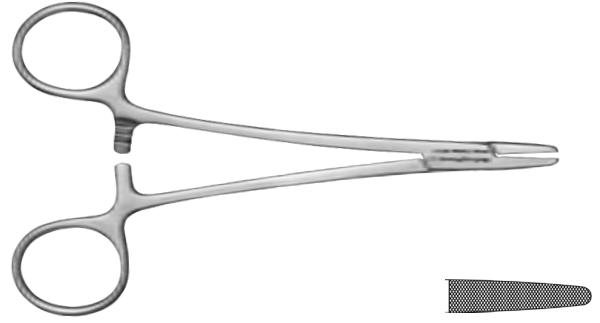

Hegar-Baumgartner Needle Holder
1-0, 2-0, 3-0, 4-0
14.5 cm **NHHB**



Mathieu Needle Holder
1-0, 2-0, 3-0, 4-0
14 cm **NHM**

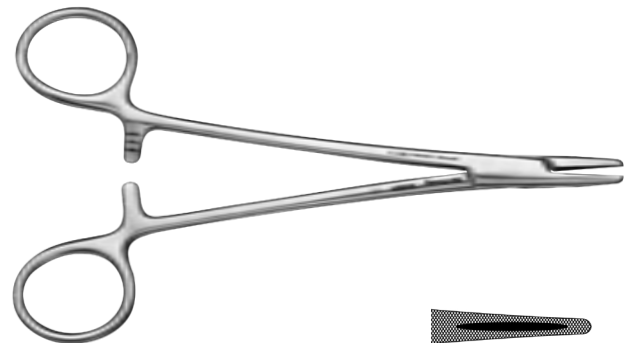

Mayo-Hegar Needle Holder
1-0, 2-0, 3-0, 4-0
16 cm **NHMH**

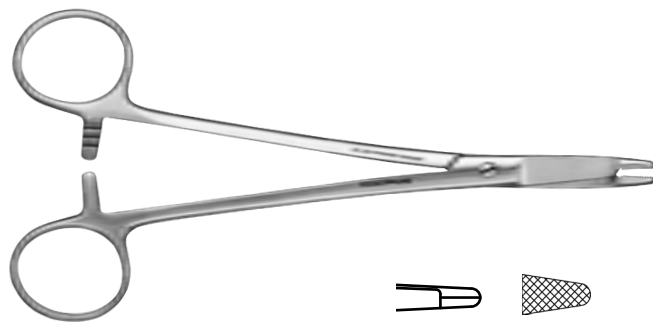

Olsen-Hegar Needle Holder Scissors
4-0, 5-0, 6-0
17 cm **NHOH**

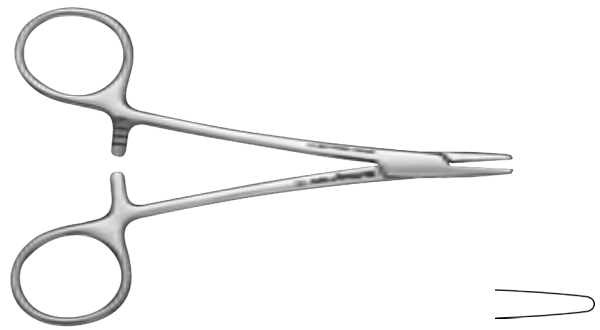

Webster Needle Holder
7-0, 8-0, 9-0, 10-0
13.25 cm **NHW**



Osteotomes

Our osteotomes are manufactured from surgical grade stainless steel for enhanced longevity and corrosion resistance. Engineered to split or spread bone, our osteotomes are available in both interchangeable or large handle designs.



Learn more about our [Osteotomes](#).



Osteotome, Straight
7-10-13-15-18 mm markings
4 mm [OSS6518S](#)



Osteotome, Curved
7-10-13-15-18 mm markings
4 mm [OSS6519CS](#)



Osteotome, Straight
7-10-13-15-18 mm markings
7.5 mm [OSS6520S](#)



Osteotome, Curved
7-10-13-15-18 mm markings
7.5 mm [OSS6521CS](#)



Jovanovic Osteotome
6 mm [OSTJ08](#)



1 Palti Osteotome

7-10-13-15-18 mm markings

2.7 mm

OSTPAL1



2 Palti Osteotome

7-10-13-15-18 mm markings

3.2 mm

OSTPAL2



3 Palti Osteotome

7-10-13-15-18 mm markings

3.7 mm

OSTPAL3



4 Palti Osteotome

7-10-13-15-18 mm markings

4.2 mm

OSTPAL4

Bone Pushers

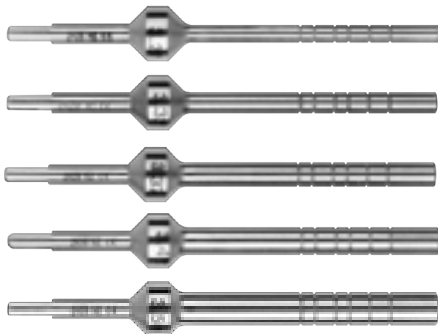

Osteotome Bone Pushers, Slightly Convex Tip, Straight

2.7 mm **OSTMPU27**

3.2 mm **OSTMPU32**

3.7 mm **OSTMPU37**

4.2 mm **OSTMPU42**

5.0 mm **OSTMPU50**



Osteotome Bone Pushers, Angled

2.7 mm **OSTMPU27A**

3.2 mm **OSTMPU32A**

3.7 mm **OSTMPU37A**

4.2 mm **OSTMPU42A**

5.0 mm **OSTMPU50A**



Osteotome Tapered Concave Tip, Straight

2.7 mm	OSTMSH27
3.2 mm	OSTMSH32
3.7 mm	OSTMSH37
4.2 mm	OSTMSH42
5.0 mm	OSTMSH50



Osteotome Tapered Concave Tip, Angulated

2.7 mm	OSTMSH27A
3.2 mm	OSTMSH32A
3.7 mm	OSTMSH37A
4.2 mm	OSTMSH42A
5.0 mm	OSTMSH50A



Osteotome Tapered Convex Tip, Straight

2.7 mm	OSTMSP27
3.2 mm	OSTMSP32
3.7 mm	OSTMSP37
4.2 mm	OSTMSP42
5.0 mm	OSTMSP50



Osteotome Tapered Convex Tip, Angulated

2.7 mm	OSTMSP27A
3.2 mm	OSTMSP32A
3.7 mm	OSTMSP37A
4.2 mm	OSTMSP42A
5.0 mm	OSTMSP50A

- Refer to [page A714](#) for a detailed listing of our [Bone Spreading Kit \(BONEKIT\)](#).



Interchangeable Osteotome Handle

[OSTMGRIFF](#)

Replacement Nut for OSTMGRIFF w/ Ring

[OSTONUT](#)

Periosteals

Handcrafted from Immunity Steel™ Alloy for optimal strength and corrosion resistance, our Periosteals feature precision finished edges for smooth tissue reflection with minimal trauma. Available in a variety of designs, our Periosteals ensure optimal access and clinical efficiencies during surgical and periodontal procedures.



Learn more about our [Periosteals](#).



12S Bennett Periosteal	
#6	P12S6
#522	P12S



14 Goldman-Fox Periosteal	
Black Line	P14X
#6	P146
#2	P14



149 Periosteal Elevator	
#6	P1496
#522	P149



15 Freer Periosteal
#6 **P156**
#522 **P15**



16 Freer Periosteal
#6 **P166**
#522 **P16**

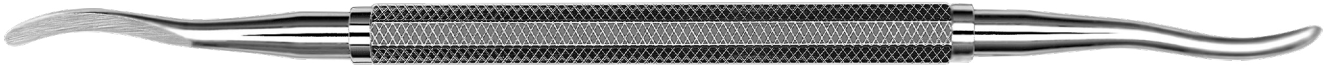

1 Hopkins Periosteal Elevator
#522 **P1**



1 Hopkins Periosteal Elevator
#6 **P1H6**



2 Hopkins Periosteal Elevator
#6 **P26**
#522 **P2**



4 Hoexter Periosteal
#6 **HOEXTER4**



20 Sicilia Periosteal	
#6	P20SIC6
#2	P20SIC



20 (LH) Hirschfeld Periosteal	
#6	P206
#2	P20



24G Sicilia Periosteal	
#6	P24GSIC6
#522	P24GSIC



24G Periosteal	
Black Line, Short	P24GSPX
#6	P24G6
#6, Short	P24GSP6
#5	P24GSP
#2	P24G



3 Mead Periosteal Elevator	
#6	P36
#522	P3



8D Periosteal DE	
#6	P8D6
#522	P8D



9 Molt Periosteal Elevator	
Black Line	P9X
#6	P96
#522	P9



P9/PA DE Periosteal #6 Handle	
#6	P9/PA6
#522	P9/PA



9A Allen Periosteal Elevator	
#6	P9A6
#522	P9A



9H Howard Periosteal Elevator	
#6	P9H6
#522	P9H



Benque Periosteal	
#6	PBQ6
#522	PBQ



Demirel Periosteal	
#6, Short	PDEMIRELS6



Donos Periosteal
Black Line **PDONOS**



Urban Mini Me Microsurgical Periosteal
Black Line **PFIWDS1MKX**
#6 **PFIWDS1MK**



Woodson Periosteal
Black Line **PFIWDS1X**
#6, Short **PFIWDS1S6**

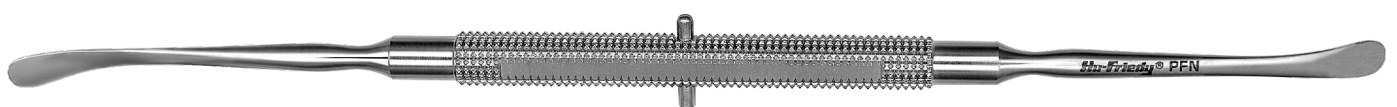

Freer Nasal Periosteal
PFN

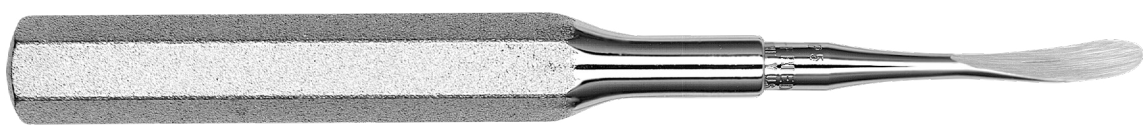

5 Molt SE Periosteal Elevator
#502 **P5**

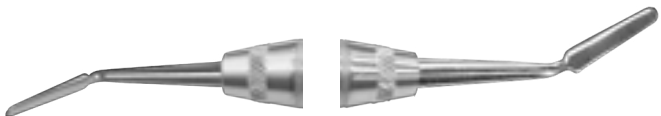

Grisdale Periosteal Elevator
#6 **PGR1**



2 Hourigan Woodson Periosteal
#6 **PH26**
#41 **PH2**



2 Hourigan Modified Woodson Periosteal
#6 **PH26M**

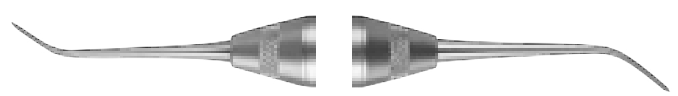

#2 Kalla Periosteal
PH2KALLA



1 Kramer-Nevins Periosteal Elevator

#6	PKN16
#41	PKN1



152 Kramer-Nevins Periosteal

#6	PKN1526
#2	PKN152



152 Kramer-Nevins Periosteal, Black Line

Black Line	PKN152X
Black Line, Short	PKN152SX



PM Split Periosteal

Black Line, Short	PMSPLITSX
-------------------	------------------

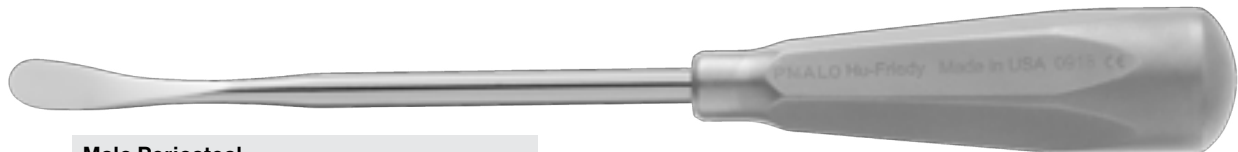

Malo Periosteal

	PMALO
--	--------------

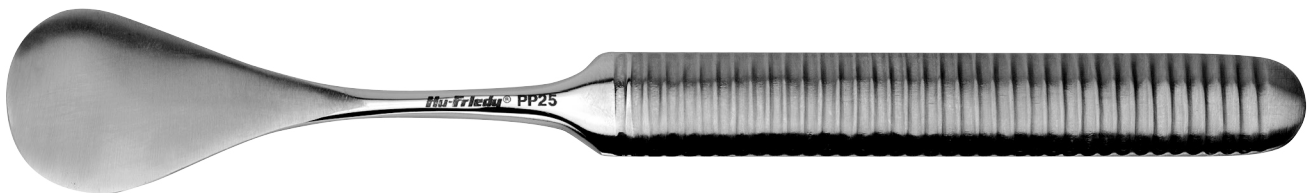

25 Palti Periosteal

	PP25
--	-------------



Implant Periosteal

#6	PP5590SIM
----	------------------



Periosteal, Allen Elevator, Posterior	
Black Line	PPAELPX
Black Line, Short	PPAELPSX
#6	PPAELP
#6, Short	PPAELS6



Periosteal, Allen Elevator, Anterior	
Black Line	PPAELAX
Black Line, Short	PPAELASX
#6	PPAELA
#6, Short	PPAELAS6

Periosteal, Allen Elevator	
Black Line	PPAELX
Black Line, Short	PPAELSX
#6	PPAEL



Modified Buser/Hourigan Periosteal, Small	
Black Line	PPBUH2M2X

Modified Buser/Hourigan Periosteal, Large	
Black Line	PPBUH2MX



1/2 Buser Modified PJO1/2 & Chisel 13KL Periodontal Chisel	
#6	PPBUSE1/26



1/3 Buser Modified PJO1/3 & Chisel 13KL Periodontal Chisel	
#6	PPBUSE1/36



Buser Periosteal Elevator	
Black Line	PPBUSERX
Black Line, Short	PPBUSERSX
#6	PPBUSER6
#10	PPBUSER



1 Labanca Periosteal	
#6	PPLABANCA6
#10	PPLABANCA



2 Labanca Periosteal Modified	
#6	PPLABANC26
#6, Short	PPLABAN2S6
#41	PPLABANCA2



3 Labanca Periosteal Modified	
Black Line	PPLABANC3X
#6	PPLABANC36
#41	PPLABANCA3



#3/9A Periosteal	
#6	PPR3/9A6
#522	PPR3/9A

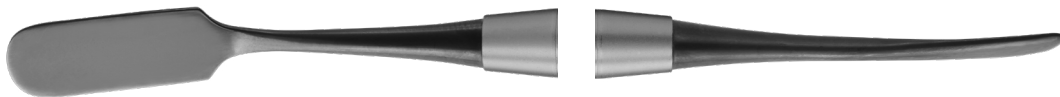

PR-3 Prichard Periosteal	
Black Line	PPR3X
#6	PPR36
#6, Short	PPR3S6
#522	PPR3
#522, Short	PPR3S
Modified	PPR3M



Spahr Papilla Periosteal	
#6	PPSPAHR6

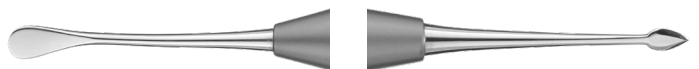

Periosteal Splitter Steigmann	
Smooth	PPSTEIG



Williger Periosteal, Large	
	PWILL



1 Trombelli Periosteal
#6 **PTROM16**



Swiss Perio 24G Periosteal
Black Line **SPP24GSPX**



Swiss Perio SIC Periosteal
Black Line **SPP24GSICX**



Swiss Perio Periosteal
Black Line **SPP24GSP2X**



Swiss Perio PH2 Periosteal
Black Line **SPPH2X**



Swiss Perio SCHL Periosteal
Black Line **SPPSCHLEEX**



23 Seldin Periosteal Retractor
P23



1 Hourigan Periosteal - 23 Serrated
PH1



Periotomes

Our Periotomes are designed to facilitate the removal of teeth with minimal damage to the surrounding alveolar bone by severing the periodontal ligament with the use of the sharp, thin clinically designed blades.



Learn more about our [Periotomes](#).

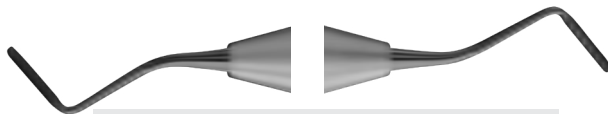

Periotome, Posterior	
Black Line	PT1X
#6	PT1

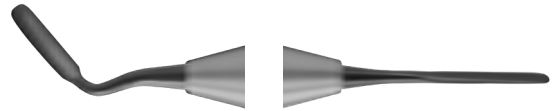

Wise Periotome	
Black Line	PEREURX
#6	PEREUR

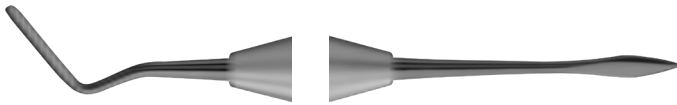

Periotome, Anterior	
Black Line	PT2X
#6	PT2



Periotome, Posterior, Right	
Black Line	PT3X
#6	PT3



Periotome, Anterior, Angled	
Black Line	PT5X
#6	PT5



Periotome, Posterior, Left	
Black Line	PT4X
#6	PT4



Periotome, Anterior, Straight	
Black Line	PT6X
#6	PT6



Periotome Tips	
Interchangeable Periotome Tip, Straight Wide	PTI7
Interchangeable Periotome Tip, Straight Narrow	PTI8
Interchangeable Periotome Tip, Angulated	PTI9
Interchangeable Periotome Tip, Mesial/Distal Angulated	PTI10

Periotome Handle	
Interchangeable Periotome Handle	PTIH

Retractors

Our variety of Retractors are used to hold mucoperiosteal flaps, cheeks, lips and tongue away from the surgical area.



Learn more about our [Retractors](#).

Cheek Retractors



50% actual size

Bishop Cheek Retractor

CRB

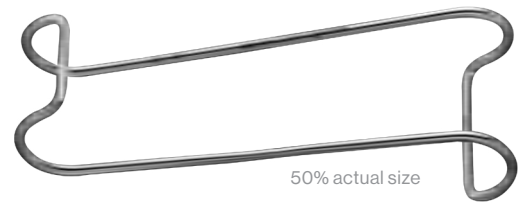

50% actual size

Retractor Columbia Cheek

CRC

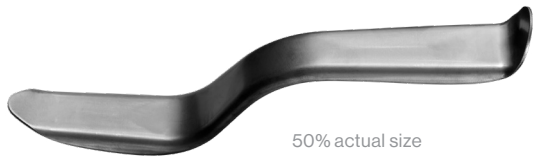

50% actual size

University of Minnesota Retractor

Black Line

CRMX

Stainless Steel

CRM



50% actual size

Cawood-Minnesota Retractor

CRM2



50% actual size

Simion Cheek Retractor

CRMS

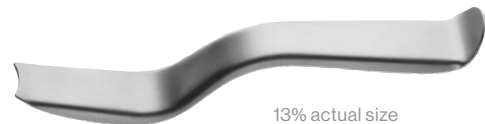

13% actual size

Urban Cheek Retractor

CRURBAN



50% actual size

Modified Minnesota Retractor, Serrated

CRMT



Labanca Malleable Retractors, Serrated

Set of 3 **CRLABANCA**

44% actual size

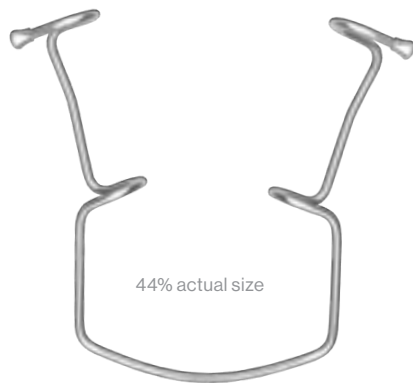

44% actual size

Orringer Retractor

Medium **CRO2**

Large **CRO3**

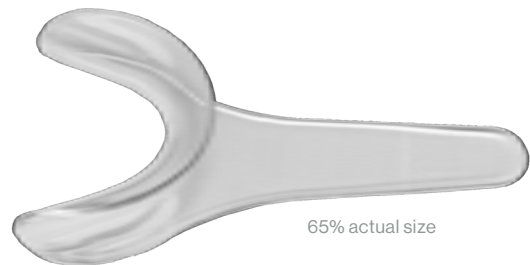

65% actual size

Plastic Retractors

Package of 2

Adult **CRPA**

Child **CRPC**

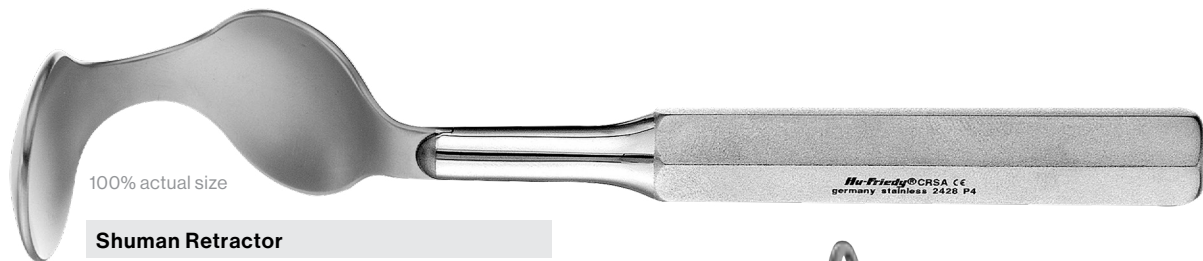

100% actual size

Shuman Retractor

Adult **CRSA**



50% actual size

Farabeuf Tissue Retractor Twin Set

TRFB

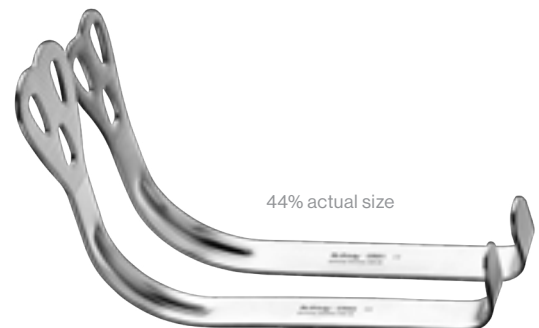

44% actual size

Weider Cheek & Tongue Retractor

Small **CRW1**

Large **CRW2**

Tissue Retractors



Sinus Retractor
#504 **SGRT**



Brenner Sinus Retractor
#510 **SGRTB**



50 Channel Retractor
SR50



8 Surgical Retractor
SR8



9 Ramus Retractor
SR9

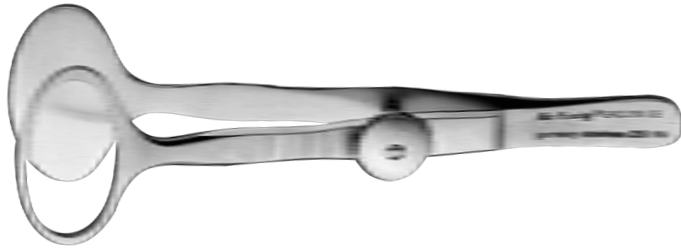

Desmarres Chalazion Retractor, Medium

SRC3M



Sinus Retractor Misch 10

SRM10



Sinus Retractor Misch 15

SRM15

Henahan Retractors



1 Henahan Retractor

TRH1



2 Henahan Retractor

TRH2



2/3 Henahan Retractor

TRH2/3



3 Henahan Retractor

TRH3



Implant Retractor
23 cm **IR**



Middeldorp Retractor
17 cm x 14 cm **RSMID1**



Middeldorp Retractor
22 cm x 20 cm **RSMID2**



Malo Surgical Retractor
SRMALO



1 Surgical Retractor
7 x 25 mm **SR1**

2 Surgical Retractor
10 x 42 mm **SR2**

3 Surgical Retractor
12 x 55 mm **SR3**



2 Austin Tissue Retractor
TRA2



Rongeurs

We offer an extensive portfolio of rongeurs, including full round end cutting, end cutting and side cutting designs, engineered for trimming and recontouring alveolar bone and gross tissue removal.



Learn more about our [Rongeurs](#).

Side Cutting



18M Double Action Side-Cutting
17 cm **R18M**



5 Rongeur
17 cm **R5**



5S Cleveland Rongeurs
15 cm **R5S**



18 Hu-Friedy™ Rongeurs
16.5 cm **R18**

End Cutting

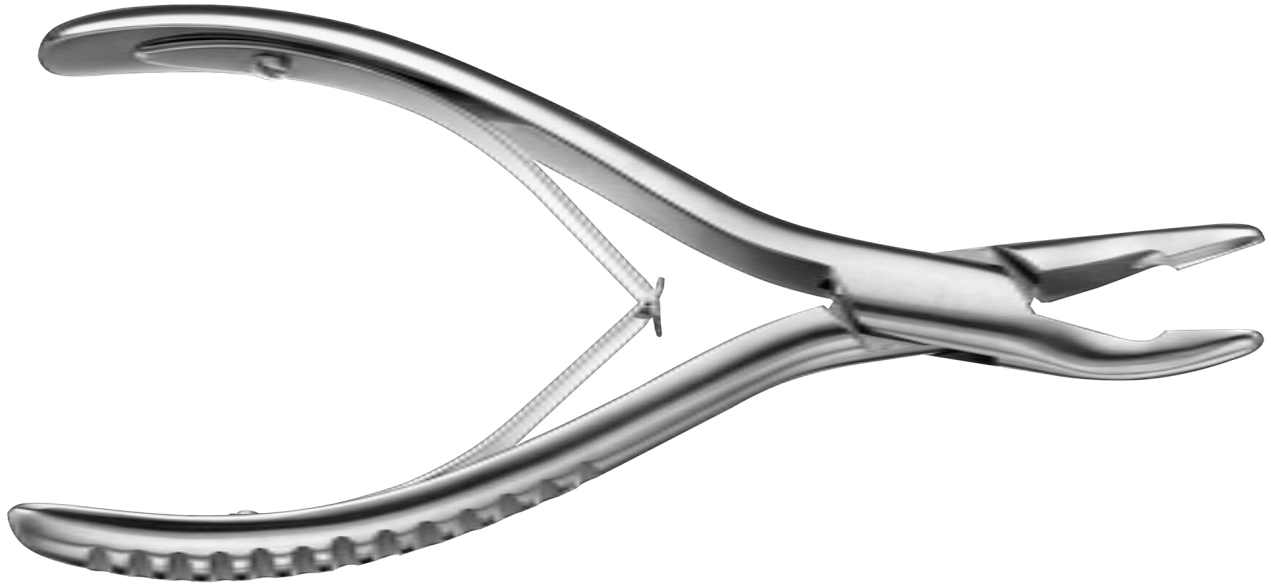

1A Mead Rongeurs
16.5 cm **R1A**

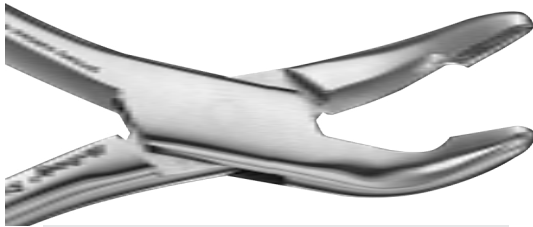

1 Hu-Friedy™ Rongeurs
16.5 cm **R1**



3H Dean Rongeurs
17 cm **R3H**



4 Cleveland Rongeurs
14 cm **R4**



4A Cleveland Rongeurs
17 cm **R4A**



15 Hu-Friedy™ Rongeurs
16.5 cm **R15**



Kramer-Nevins Rongeurs
14.5 cm **RKN**

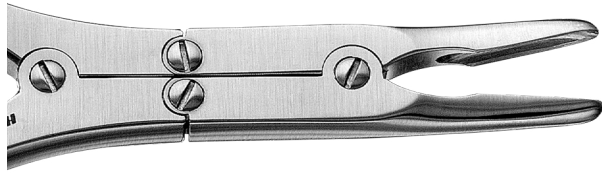

Beyer Rongeurs
18 cm **RBEY**

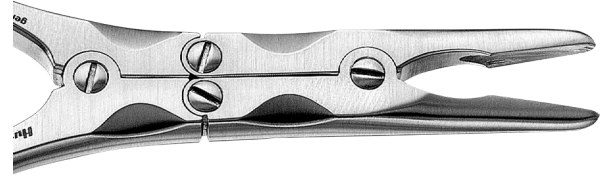

Boehler Rongeurs
16 cm **RBOE**
15 cm, Curved **RBOEC**



Friedman Rongeurs
14 cm **RF**

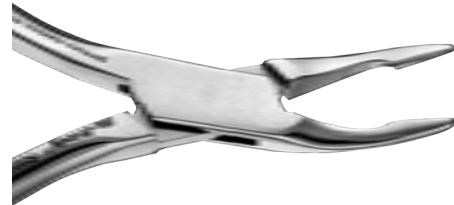

Mini Friedman Rongeurs
14.5 cm **RMF**



Mini 90° Friedman Rongeurs
14.5 cm **RMF90**

Both Side and End Cutting



30° Blumenthal Rongeurs
14.5 cm **RBL**

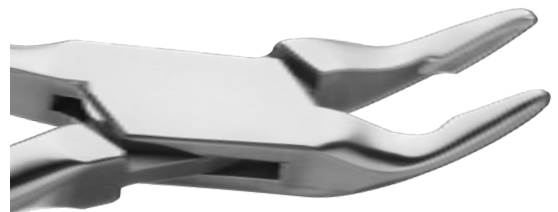

45° Blumenthal Rongeurs
14.5 cm **RBL45**



90° Blumenthal Rongeurs
14.5 cm **RBL90**

Root Tip Picks

Our selection of Root Tip Picks are delicate instruments designed for the removal of root tips in difficult-to-reach areas.



Learn more about our [Root Tip Picks](#).

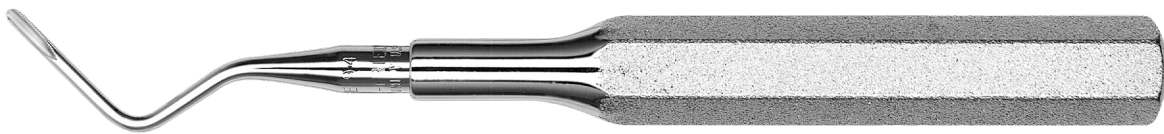

#94 Root Tip pick
#502 [E94](#)



#95 Root Tip Pick
#502 [E95](#)

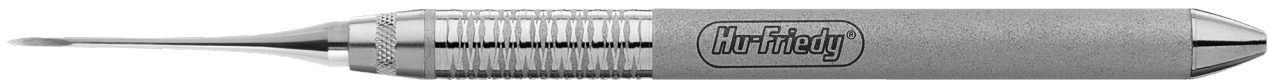

9 West Root Tip Pick
#6 [E96](#)
#503 [E9](#)



9L Root Tip Pick
#6 [E9L6](#)
#503 [E9L](#)



9R Root Tip Pick
#6 [E9R6](#)
#503 [E9R](#)

Suggested Pair



Root Tip Picks

Surgical



10 Davis DE Root Tip Pick	
#6	ED106
#2	ED10



11 Davis DE Root Tip Pick	
#6	ED116
Spoon Blade	ED11



1 Davis SE Root Tip Pick	
#6	ED16
#503	ED1

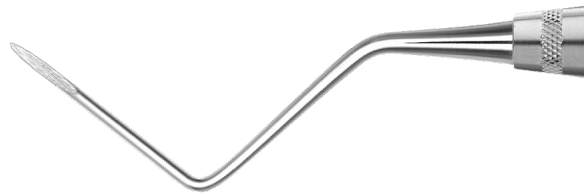

2 Davis SE Root Tip Pick	
#6	ED26
#503	ED2



3 Davis SE Root Tip Pick	
#6	ED36
#503	ED3

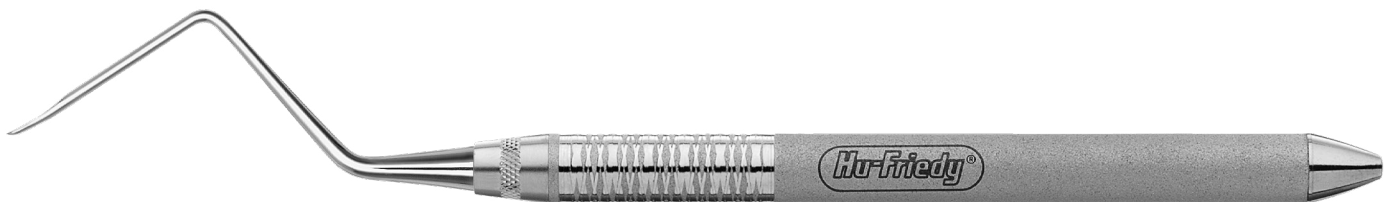

4 Davis SE Root Tip Pick	
#6	ED46
#503	ED4

Suggested Pair



#1 Heidbrink Root Tip Pick
#502 **EHB1**



13/14 Heidbrink DE Root Tip Pick
Black Line **EHB13/14X**
#6 **EHB13/146**
#522 **EHB13/14**



13/14 Heidbrink DE Root Tip Pick, Heavy
#6 **EHB13/14H6**
#522 **EHB13/14H**



2 Heidbrink Root Tip Pick
#502 **EHB2**

2 Heidbrink Root Tip Pick-Heavy
#502 **EHB2H**



3 Heidbrink Root Tip Pick
#502 **EHB3**

3 Heidbrink Root Tip Pick, Heavy
#502 **EHB3H**



4 Heidbrink Root Tip Pick
#502 **EHB4**



5 Heidbrink Root Tip Pick
#502 **EHB5**

Suggested Pair

Suggested Pair



Root Tip Picks

Surgical

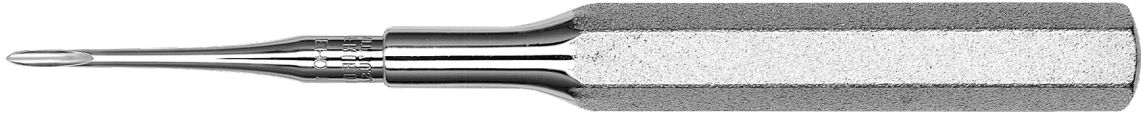

1 Howard Root Tip Pick
#502 **EHO1**



2/3 Howard DE Root Tip Pick
#6 **EHO2/36**
#522 **EHO2/3**

Suggested Pair

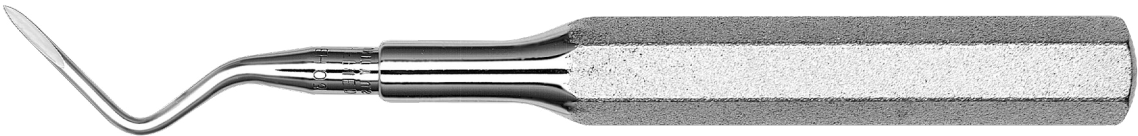

2 Howard Root Tip Pick
#502 **EHO2**



#3 Howard Root Tip Pick
#502 **EHO3**



#4 Howard Root Tip Pick
#502 **EHO4**



RAF1 Root Tip Pick
#504 **ERAF1**



RAF3 Root Tip Pick, Modified
#504 **ERAF3KA**

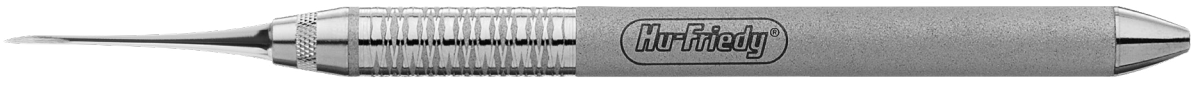

1 West Apical Root Tip Pick	
#6	EWS16
#1	EW1



2 West Apical Root Tip Pick	
#6	EW26
#1	EW2



4 West Apical Root Tip Pick	
#6	EW46
#1	EW4

..... Suggested Pair



3 West Apical Root Tip Pick	
#6	EW36
#1	EW3



5 West Apical Root Tip Pick	
#6	EW56
#1	EW5

..... Suggested Pair



6 West Apical Root Tip Pick	
#6	EW66
#1	EW6



Scalpel Blades & Handles

Our Scalpel Handles feature balanced designs and are manufactured from the finest grade surgical stainless steel for optimal control and enhanced longevity. Paired with our surgical Scalpel Blades which are crafted from the finest materials for strength and durability, we offer both microsurgical and standard styles to match clinician and procedural preferences.



11 Sterile Scalpel Blades

QTY:100/box

Carbon Steel [10-255-11](#)

Surgical Grade Stainless Steel [40-811](#)



12 Sterile Scalpel Blades

QTY:100/box

Carbon Steel [10-255-12](#)

Surgical Grade Stainless Steel [40-812](#)



12D Sterile Scalpel Blades

QTY:100/box

Carbon Steel [10-256-12](#)

Surgical Grade Stainless Steel [40-812B](#)



15 Sterile Scalpel Blades

QTY:100/box

Carbon Steel [10-255-15](#)

Surgical Grade Stainless Steel [40-815](#)



15C Sterile Scalpel Blades

QTY:100/box

Carbon Steel [10-256-15](#)

Surgical Grade Stainless Steel [40-815C](#)



25 Sterile Scalpel Blades

QTY:100/box

Carbon Steel [10-255-25](#)

Surgical Grade Stainless Steel [40-825](#)

Mini Scalpel Blades



Full Radius Point Mini Scalpel Blades, Sterile

QTY: 12/box

[MB63](#)



Single Edge Mini Scalpel Blades, Sterile

QTY: 12/box

[MB64](#)



Curved Edge Mini Scalpel Blades, Sterile

QTY: 12/box

[MB67](#)



Full Radius Round Scalpel Blades, Sterile

QTY: 12/box

[MB69](#)



Single Edge Micro Mini Scalpel Blades, Sterile

QTY: 12/box

[MIM64](#)



Scalpel Blade Handles

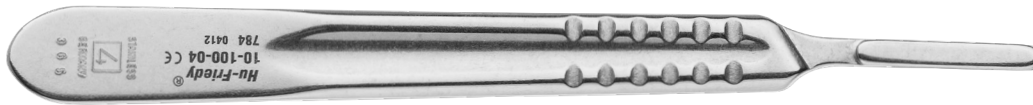

#4 Scalpel Handle, Lab Size

10-100-04

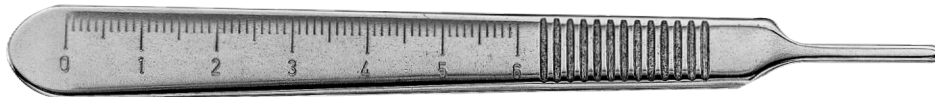

#3 Scalpel Handle

10-130-03

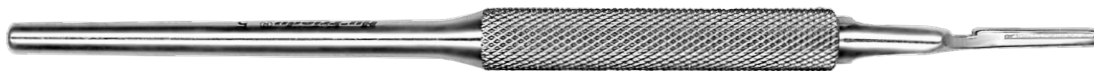

#5 Scalpel Handle, Round Straight

10-130-05



#5 Scalpel Handle, Round

10-130-05A

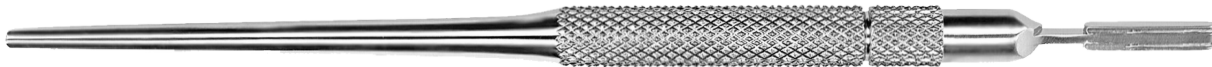

#5 Scalpel Handle, Double

1 mm 1013005D1

1.5 mm 10-130-05D



#7 Scalpel Handle

10-130-07



#7K Scalpel Handle

10-130-07K



#5 Scalpel Handle, European Style

10-130-05E



#5 European Style Matte Scalpel Handle

10-130-5EM



Paquette Palatal Knife

KPQ

Mini Scalpel Blade/Mirror Handles



ResinEight™ Mini Scalpel Handle

10-130-08



Mini Blade Scalpel Handle

1-015



Microsurgical Mini Scalpel Blade/Mirror Handle,
Stainless Steel

SHDPV



Mini Scalpel Blade/Mirror Handle Titanium

SHTMBH



Additional Products



#7 Mini Scalpel Blade Handle

10-130-70









Mini and Micro Mini Blade Wrench

MBW



Blades & Blade Handles

	Size
	10
	11
	12
	15
	25
	12B
	15C

Aspen Surgical® Blades w/ Rib-Back Design, Sterile

50 per box - Carbon Steel

Size 12 [371112](#)

Size 15 [371115](#)

Aspen Surgical® Blades, Non-Sterile

6 per strip - Carbon Steel

Size 15 [371315](#)

Size 25 [371325](#)

Aspen Surgical® Bard-Parker® Blades, Sterile, Conventional

50 per box - Stainless Steel

Size 12 [371212](#)

Size 15 [371215](#)

Size 12B [371712](#)

Size 15C [371716](#)



Disposable Scalpels

Aspen Surgical® Bard-Parker® Disposable Scalpel, Sterile, Conventional

10 per box - Stainless Steel

Size 10	371610
Size 11	371611
Size 12	371612
Size 12B	371613
Size 15	371615

Aspen Surgical® Bard-Parker® Surgical Blade Handle, Non-Sterile, Conventional

5 per box

Size 3	371030	Fits Blades 10 to 15
Size 4	371040	Fits Blades 20 to 25
Size 5	371050	Fits Blades 10 to 15
Size 6	371060	Fits Blades 20 to 25

Beaver® Mini-Blades

Beaver® 6400 Mini-Blade

20 per box

Grindless, rounded tip, sharp on one side, green **376400**

Beaver® 6700 Mini-Blade

20 per box

Grindless, smaller alternative to #15 general blade, orange **376700**

HuCare

Surgical Instrument Care Program



**HuFriedyGroup offers free servicing for the life of your instruments.*
When you purchase the highest quality products, it is critical
to keep them in optimal working condition. ***

When you purchase the highest quality products, it is important to keep them in optimal working condition.

Sign up to:

- Protect your investments through regular, free service
- Free up valuable time to focus on providing positive clinical outcomes for your patients
- Ensure accurate servicing by the same HuFriedyGroup artisans that manufactured your instruments



Visit [HuFriedyGroup.com/HuCare-Surgical/SignUp](https://www.hufriedygroup.com/HuCare-Surgical/SignUp)

*Covered for the life expectancy of product, not life of doctor or practice. Available in the US only.

HuFriedyGroup
The Best In Practice

Scissors

Our Scissors are designed to exact specifications for balanced and smooth control. We offer an extensive selection including microsurgical, suture, crown and gold, bandage and general surgery scissors.



Learn more about our [Scissors](#).

Scissors Styles

Perma Sharp™ Scissors

Featuring tungsten carbide inserts bonded to surgical-grade stainless steel on both cutting edges for smooth, controlled cutting and maximum durability.

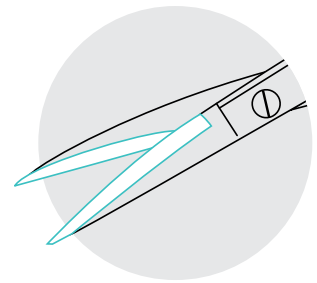

Black Line Scissors with Super Cut Blades

Feature a performance engineered coating for optimal edge retention, reduced light reflection afforded by the black matte finish, and enriched contrast and visual acuity at the surgical site and underlying tissue.

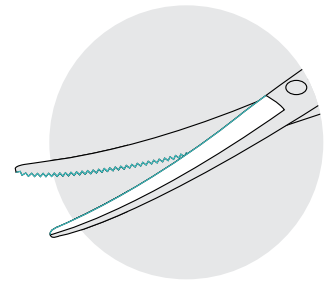

Super Cut Scissors

Cutting blade honed/serrated to "razor" sharpness with opposing blade finished with fine serrations to avoid tissue slippage.

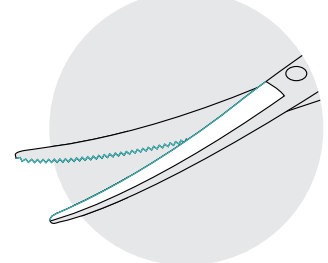

Standard Series Scissors

A wide array of cutting blades to fit a variety of needs.





14 LaGrange Scissors, Curved, Super-Cut

11.5 cm (4.5"), 1 serrated blade

Black Line **S14SCX**

Standard **S14SC**

14 LaGrange Scissors

11.5 cm (4.5"), 1 serrated blade

Standard **S14**



16 Goldman-Fox Scissors, Curved, Super-Cut

12.5 cm (5"), 1 serrated blade

Black Line **S16SCX**

Standard **S16SC**

16 Goldman-Fox Scissors

12.5 cm (5"), 1 serrated blade

Standard **S16**



17 Iris Scissors, Straight, Super-Cut

11.5 cm (4.5"), 1 serrated blade

Black Line **S17SCX**

Standard **S17SC**

17 Iris Scissors, Straight

11.5 cm (4.5")

Standard **S17**



18 Iris Scissors, Curved, Super-Cut

11.5 cm (4.5"), 1 serrated blade

Black Line **S18SCX**

Standard **S18SC**

18 Iris Scissors, Curved

11.5 cm (4.5")

Standard **S18**



Metzenbaum Scissors, Super-Cut

14.25 cm (5.5"), 1 serrated blade

S19SCX



Goldman-Fox Scissors, Straight, Super-Cut

13.5 cm (5.25"), 1 serrated blade

S20SCX



10 Scissors
 13.5 cm (5.3"), 1 serrated blade
 Super-Cut **S10SC**
 Standard **S10**



Scissors Cortellini, Super-Cut, Curved
 12 cm (4.75"), 1 serrated blade
SCORTSC



Kelly Perma Sharp™ Scissors, Curved
 16 cm (6.25"), 1 serrated blade
S5001

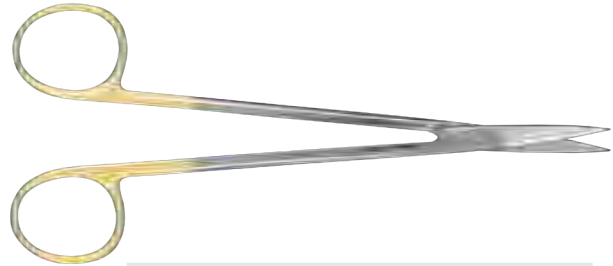

Kelly Perma Sharp™ Scissors, Straight
 16 cm (6.25"), 1 serrated blade
S5002



Wire Cutting Perma Sharp™ Scissors
 12 cm (4.75"), 1 serrated blade
S5095



Dean Perma Sharp™ Scissors
 16 cm (6.25"), 1 serrated blade
S5009



Locklin Perma Sharp™ Scissors, Open Shank
 16 cm (6.5"), 1 serrated blade
S5011

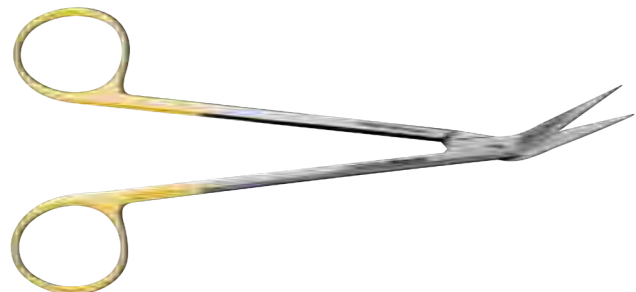

Locklin Perma Sharp™ Scissors, Closed Shank
 16 cm (6.5"), 1 serrated blade
S5012



Scissors

Surgical



Metzenbaum Perma Sharp™ Scissors, Straight, Blunt
14.5 cm (5.5")

S5054



Metzenbaum Perma Sharp™ Scissors, Curved, Blunt
14.5 cm (5.5")

S5055

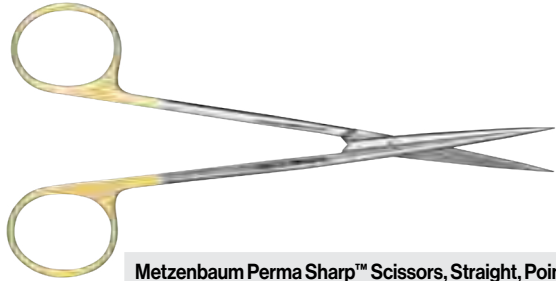

Metzenbaum Perma Sharp™ Scissors, Straight, Pointed
14.5 cm (5.5")

S5056

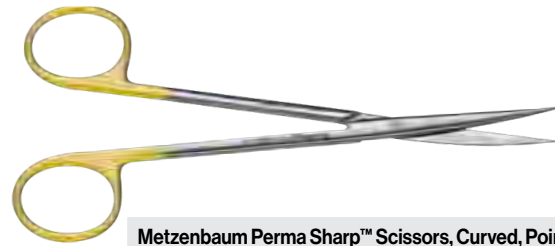

Metzenbaum Perma Sharp™ Scissors, Curved, Pointed
14.5 cm (5.5")

S5057

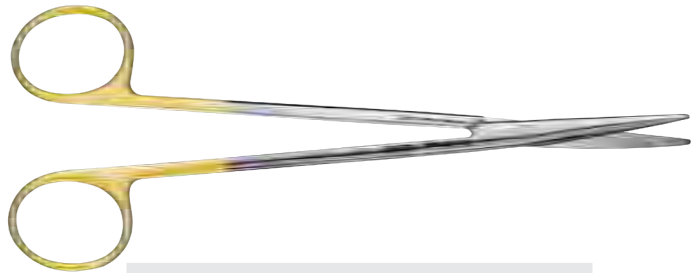

Metzenbaum Perma Sharp™ Scissors, Curved, Delicate
18 cm (7")

S5069

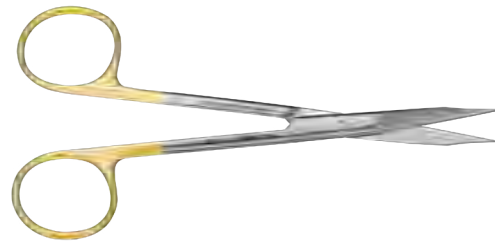

Goldman-Fox Perma Sharp™ Scissors, Straight
13 cm (5"), 1 serrated blade

S5080



Goldman-Fox Perma Sharp™ Scissors, Curved
13 cm (5"), 1 serrated blade

S5081



Iris Perma Sharp™ Scissors Straight
11.5 cm (4.5")

S5082



Iris Perma Sharp™ Scissors Curved
11.5 cm (4.5")

S5083



1 Kelly Scissors, Curved
16 cm (6.25"), 1 serrated blade

S1



1L Kelly Scissors, Curved
18 cm (7"), 1 serrated blade

S1L



2 Kelly Scissors, Straight
16 cm (6.25"), 1 serrated blade

S2



2L Kelly Scissors, Straight
18 cm (7"), 1 serrated blade

S2L



3 Mayo Scissors, Curved
14.5 cm (5.75")

S3



4 Mayo Scissors, Straight
14.5 cm (5.75")

S4



5 Wagner Scissors, Straight
11.5 cm (4.5"), 1 serrated blade

S5



6 Wagner Scissors, Curved
11.5 cm (4.5"), 1 serrated blade

S6



7 Wagner Scissors, Angled
11.5 cm (4.5"), 1 serrated blade

S7



8 Quinby Scissors
12.5 cm (5"), 1 serrated blade

S8



Scissors

Surgical



9 Dean Scissors

16.5 cm (6"), 1 serrated blade

S9



11 Locklin Scissors

16 cm (6.25"), 1 serrated blade

S11



12 Locklin Scissors

16 cm (6.25"), 1 serrated blade

S12



13 Suture Scissors

15 cm (6")

S13

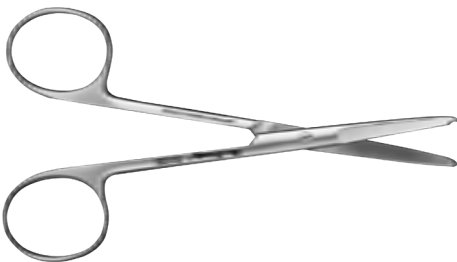

13S Suture Scissors

12 cm (4.75")

S13S

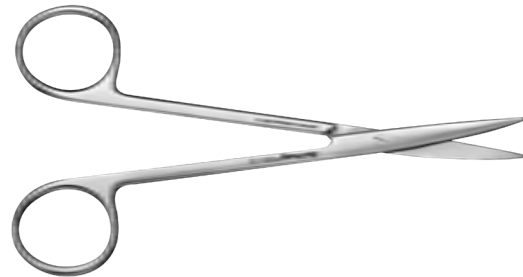

15 Sullivan Scissors

14 cm (5"), 1 serrated blade

S15



#21 Surgical Scissors, Straight, Pointed

14.5 cm (5.75")

S21



#22 Surgical Scissors, Straight, Blunt

14.5 cm (5.75")

S22



#23 Surgical Scissors, Curved, Pointed

14.5 cm (5.75")

S23



Baby Metzenbaum Scissors

12.5 cm (5")

SMB



Crown & Gold Scissors, Curved
12 cm (4.75")

SCGC



Crown & Gold Curved, Scissors, Pedro
9 cm (3.5")

SCGCP

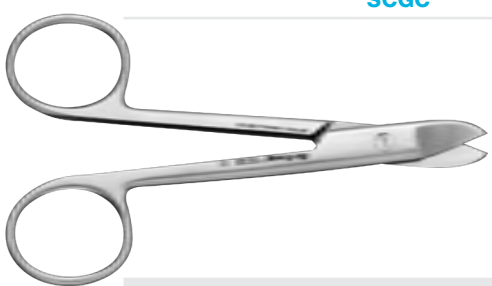

Crown & Gold Scissors, Straight
12 cm (4.75")

SCGS

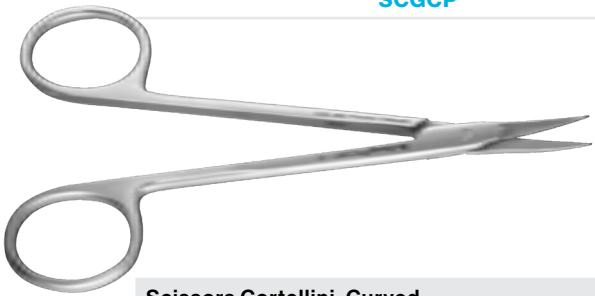

Scissors Cortellini, Curved
12 cm (4.75")

12 cm **SCORT**



Strabismus Scissors, Straight
11.5 cm (4.5")

S40



Joseph Scissors
14 cm (5"), 1 serrated blade

Curved **SJC**

Straight **SJS**

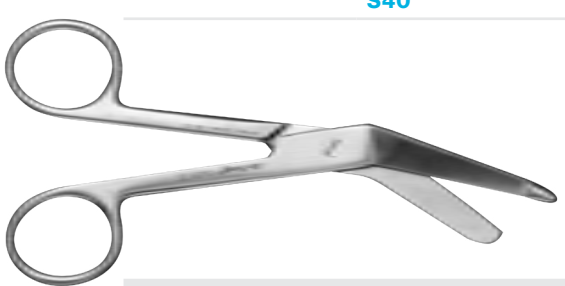

Lister Bandage Scissors
14.5 cm (5.75")

SLB



Microsurgical Scissors



Swiss Perio Microsurgical Scissors

12 cm (4.75"), 1 serrated blade

SPSPV



Swiss Perio Microsurgical Scissors, 45°

12 cm (4.75"), 1 serrated blade

SPSPV45



Castroviejo Microsurgical Scissors

16.25 cm (6.5"), 1 serrated blade

Black Line

SPVX

Castroviejo Microsurgical Scissors

18 cm (7"), 1 serrated blade

Standard

SPV

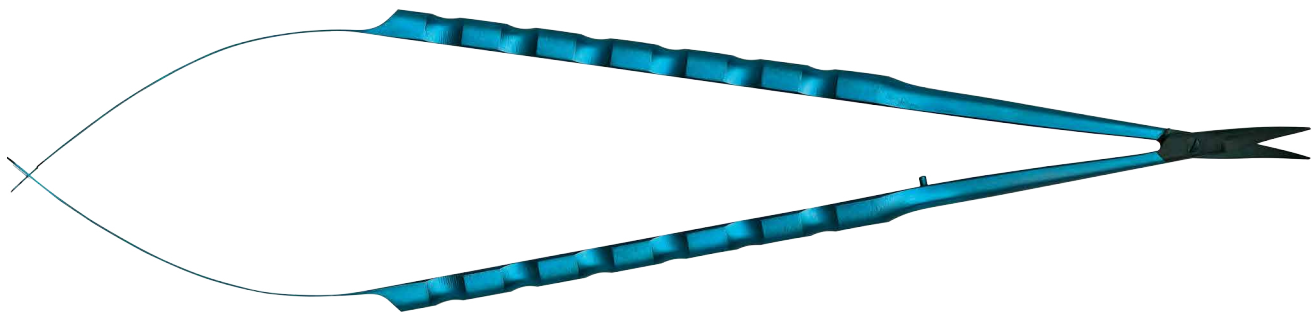

Castroviejo Microsurgical Scissors, Curved

18 cm (7")

Titanium

STMBH



31 Castroviejo Scissors











10 cm (4")

S31

Sutures



Our Perma Sharp™ Sutures are specifically designed for dentists ensuring efficient and reliable soft tissue closure. 300 Series Stainless Steel, the ideal alloy for dental suture needles, ensures a strong sharp needle pass after pass.

 Learn more about our complete [Sutures Portfolio](#).

Premium Cut		Regular Cut	
C-1 10.7 mm 3/8 Circle Premium Reverse Cut		C-4 12.7 mm 1/2 Circle Reverse Cut	
C-3 13 mm 3/8 Circle Premium Reverse Cut		C-6 18.7 mm 3/8 Circle Reverse Cut	
		C-7 24.3 mm 3/8 Circle Reverse Cut	
		C-9 23 mm 1/2 Circle Reverse Cut	
		C-17 12 mm 3/8 Circle Reverse Cut	
		C-19 18.3 mm 1/2 Circle Reverse Cut	
		C-22 16.2 mm 3/8 Circle Reverse Cut	
		C-43 16.2 mm 1/2 Circle Reverse Cut	
		D-14 17.5 mm 1/2 Circle Cutting End Taper	

Needles Cross Reference Chart

Hu-Friedy	Ethicon	Promed, Davis & Geck/USSC	Look, Patterson	Havel, Henry Schein
C-1	P-1	PRE-1	C-1	C-1
C-3	P-3	PRE-2	C-3	C-3
C-6	FS-2, PS-2	CE-4, PRE-4	C-6, PCV-31	C-6, PC-31
C-7	FS-1, PS-1	CE-6, PRE-6, DS-26, DSS-2	C-8	C-7, C-33
C-9	X-1	C-30	C-20, C-21	C-9, C-31
C-17	C-3	CE-2	C-17	C-17, C-16
C-19	J-1		C-19	C-19
C-22	FS-3, PS-3	CE-3, PRE-3	C-22	C-22, PC-34
C-43	X-8		C-19, C-26	C-26, C-43
D-14	V-5	DT-31, CV-332	D-14	D-14, Y-5
T-28	RB-1	T-31, CV-331	T-28	

T-4 22.2 mm 1/2 Circle Taper Point	
T-28 17.5 mm 1/2 Circle Taper Point	

Ethicon is a trademark of Johnson and Johnson
 Promed and Look are trademarks of Surgical Specialties
 Covidien / USSC are trademarks of Covidien
 Havel is a trademark of Havel, Inc.



Absorbable

Plain Gut



Plain Gut Perma Sharp™ Sutures

12 per box

4-0 Gut, Plain 18" C-3 3/8 Circle Premium	PSN1644A
3-0 Gut, Plain 18" C-9 1/2 Circle Reverse Cut	PSN612A
5-0 Gut, Plain 18" C-3 3/8 Circle Premium	PSN686A
5-0 Gut, Plain 18" C-19 1/2 Circle	PSN723A
6-0 Gut, Plain 18" C-1 3/8 Circle Premium	PSN774A
4-0 Gut, Plain 18" C-6 3/8 Circle Reverse Cut	PSN7771A
3-0 Gut, Plain 27" C-7 3/8 Circle	PSNH810A
5-0 Gut, Plain 27" C-6 3/8 Circle	PSNH820A
4-0 Gut, Plain 27" C-6 3/8 Circle	PSNH821A
3-0 Gut, Plain 27" C-6 3/8 Circle	PSNH822A

Chromic Gut



Chromic Gut Perma Sharp™ Sutures

12 per box

4-0 Gut, Chromic 18" C-3 Premium	PSN1654C
6-0 Gut, Chromic 18" C-1 Premium	PSN1816C
5-0 Gut, Chromic 18" C-17 3/8 Circle	PSN385C
4-0 Gut, Chromic 18" C-17 3/8 Circle	PSN386C
5-0 Gut, Chromic 27" C-6 3/8 Circle	PSN634C
4-0 Gut, Chromic 27" C-6 3/8 Circle	PSN635C
3-0 Gut, Chromic 27" C-6 3/8 Circle	PSN636C
5-0 Gut, Chromic, 18" C-3 3/8 Circle Premium Reverse Cut	PSN687C
5-0 Gut, Chromic 27" T-28 1/2 Circle Taper	PSNU202C

PGA



PGA Perma Sharp™ Sutures

12 per box

4-0 PGA, Violet 27" D-14 1/2 Circle	PSN271V
6-0 PGA, Violet 27" T-28 1/2 Circle	PSN302V
5-0 PGA, Violet 27" T-28 1/2 Circle	PSN303V
4-0 PGA, Violet 27" T-28 1/2 Circle	PSN304V
5-0 PGA, Undyed 18" C-17 3/8 Circle	PSN385V
4-0 PGA, Undyed 18" C-17 3/8 Circle	PSN386V
6-0 PGA, Violet 18" C-22 3/8 Circle	PSN387V
5-0 PGA, Violet 18" C-22 3/8 Circle	PSN388V
4-0 PGA, Violet 18" C-22 3/8 Circle	PSN389V
4-0 PGA, Violet 18" C-6 3/8 Circle	PSN392V
3-0 PGA, Violet 18" C-6 3/8 Circle	PSN393V
4-0 PGA, Violet 27" C-6 3/8 Circle	PSN397V
5-0 PGA, Undyed 27" C-6 3/8 Circle	PSN421V
4-0 PGA, Undyed 27" C-6 3/8 Circle	PSN422V
3-0 PGA, Violet 27" C-9 1/2 Circle	PSN460V
6-0 PGA, Undyed 18" C-1 3/8 Circle Premium	PSN489V
5-0 PGA, Undyed 18" C-1 3/8 Circle Premium	PSN490V
6-0 PGA, Undyed 18" C-3 3/8 Circle Premium	PSN492V
5-0 PGA, Undyed 18" C-3 3/8 Circle Premium	PSN493V
4-0 PGA, Undyed 18" C-3 3/8 Circle Premium	PSN494V
5-0 PGA, Undyed 18" C-19 1/2 Circle	PSN723V
4-0 PGA, Undyed 18" C-19 1/2 Circle	PSN724V

PGA Fast Absorbable



PGA FA Perma Sharp™ Sutures

12 per box

4-0 PGAFA, Undyed 18" C-3 3/8 Premium Reverse Cut	PSN510FA
5-0 PGAFA, Undyed 18" C-3 3/8 Premium Reverse Cut	PSN515FA
4-0 PGAFA, Undyed 18" C-6 3/8 Premium Reverse Cut	PSN525FA
5-0 PGAFA, Undyed 27" C-6 3/8 Premium Reverse Cut	PSN530FA
4-0 PGAFA, Undyed 18" C-6 3/8 Reverse Cut	PSN535FA
3-0 PGAFA, Undyed 18" C-6 3/8 Reverse Cut	PSN540FA
3-0 PGAFA, Undyed 18" C-9 1/2 Reverse Cut	PSN585FA

Suture Material Cross Reference Chart

Hu-Friedy	Sharp/Point/Look	Ethicon	Material
Gut, Plain	Plain Gut	Surgical Gut	Natural Absorbable Gut
Gut, Chromic	Chromic Gut	Surgical Gut	Natural Absorbable Gut
PGA Undyed	PolySyn/PGA	Vicryl Undyed	Coated, Braided Synthetic Absorbable
PGA-Violet		Vicryl Violet	Coated, Braided Synthetic Absorbable
PGA Fast Absorbable	PolySyn Fast Absorbable	Vicryl Rapide	Coated, Braided Synthetic Fast Absorbable
Black Mono Nylon	Nylon	Ethilon	Non-Absorbable Monofilament Nylon
Propylene	Polypropylene	Prolene	Non-Absorbable Monofilament
Polyester Green Braided	Polyviolene	Ethibond	Non-Absorbable Braided Polyester
Silk Black Braided	Silk	Perma-Hand Silk	Non-Absorbable Braided Silk



Non-absorbable

Silk



Silk Perma Sharp™ Sutures

12 per box

5-0 Silk, Black 18" C-22 3/8 Circle	PSN1628S
4-0 Silk, Black 18" C-9 1/2 Circle	PSN631S
3-0 Silk, Black 18" C-9 1/2 Circle	PSN632S
5-0 Silk, Black 18" C-3 3/8 Circle Premium	PSN640S
4-0 Silk, Black 18" C-3 3/8 Circle Premium	PSN641S
6-0 Silk, Black 18" C-22 3/8 Circle	PSN681S
5-0 Silk, Black 18" C-6 3/8 Circle	PSN682S
4-0 Silk, Black 18" C-6 3/8 Circle	PSN683S
3-0 Silk, Black 18" C-7 3/8 Circle	PSN684S
5-0 Silk, Black 18" C-17 3/8 Circle	PSN719S
3-0 Silk, Black, 18", C-19, 1/2 Circle	PSN733S
4-0 Silk, Black 27" T-4 1/2 Circle	PSN7342S
3-0 Silk, Black 27" T-4 1/2 Circle	PSN7343S
4-0 Silk, Black 18" C-19 1/2 Circle	PSN734S
4-0 Silk, Black 18" C-17 3/8 Circle	PSN736S
2-0 Silk, Black 18", C-9, 1/2 Circle Reverse Cut	PSN737S
3-0 Silk, Black 18" C-43 1/2 Circle	PSN7762S
4-0 Silk, Black 18" C-43 1/2 Circle	PSN7763S
5-0 Silk, Black 18" C-43 1/2 Circle	PSN7764S
3-0 Silk, Black 18" C-6 3/8 Circle	PSN7772S
5-0 Silk, Black 27" T-28 1/2 Circle	PSN870S
4-0 Silk, Black 27" T-28 1/2 Circle	PSN871S
3-0 Silk, Black 27" T-28 1/2 Circle	PSN872S
4-0 Silk, Black 27" D-14 1/2 Circle Reverse	PSN952S
3-0 Silk, Black 27" D-14 1/2 Circle Reverse	PSN953S

Nylon



Nylon Perma Sharp™ Sutures

12 per box

5-0 Nylon, Black Mono 18" C-6 3/8 Circle	PSN661N
4-0 Nylon, Black Mono 18" C-6 3/8 Circle	PSN662N
5-0 Nylon, Black Mono 18" C-3 Premium	PSN698N

Polypropylene



Polypropylene Perma Sharp™ Sutures

12 per box

5-0 Polypropylene, Blue 18" D-14 End Cut	PSN7773P
5-0 Polypropylene, Blue 18" C-4 1/2 Circle	PSN8245P
6-0 Polypropylene, Blue 18" C-17 3/8 Circle	PSN8384P
5-0 Polypropylene, Blue 18" C-17 3/8 Circle	PSN8385P
5-0 Polypropylene, Blue 18" C-22 3/8 Circle	PSN8614P
6-0 Polypropylene, Blue 18" C-22 3/8 Circle	PSN8660P
5-0 Polypropylene, Blue 18" C-6 3/8 Circle	PSN8661P
4-0 Polypropylene, Blue 18" C-6 Premium	PSN8683P
6-0 Polypropylene, Blue 18" C-3 Premium	PSN8695P
7-0 Polypropylene, Blue 18" C-1 Premium	PSN8696P
6-0 Polypropylene, Blue 18" C-1 Premium	PSN8697P
5-0 Polypropylene, Blue 18" C-3 Premium	PSN8698P
5-0 Polypropylene, Blue 18" T-28 Taper	PSN8756P

Polyester



Polyester Perma Sharp™ Sutures

12 per box

3-0 Polyester, Green 27" D-14 1/2 Circle	PSN6953L
5-0 Polyester, Green 18" D-14 End Cut	PSN7773L
4-0 Polyester, Green 18" C-6 3/8 Circle	PSNR683L
5-0 Polyester, Green 18" C-3 3/8 Circle	PSNR698L
3-0 Polyester, Green 18" C-6 3/8 Circle	PSNR7772L

PTFE



PTFE Perma Sharp™ Sutures

12 per box

3-0 PTFE, 18" C-6 3/8 Circle Reverse Cut	PSNPTFE1
3-0 PTFE, 18" C-22 3/8 Circle Reverse Cut	PSNPTFE2
4-0 PTFE, 18" C-6 3/8 Circle Reverse Cut	PSNPTFE3
4-0 PTFE, 18" C-3 3/8 Circle Reverse Cut Premium	PSNPTFE4
4-0 PTFE, 18" C-17 3/8 Circle Reverse Cut	PSNPTFE5
4-0 PTFE, 18" C-22 3/8 Circle Reverse Cut	PSNPTFE6
5-0 PTFE, 18" C-13/8 Circle Reverse Cut Premium	PSNPTFE7
5-0 PTFE, 18" C-3 3/8 Circle Reverse Cut Premium	PSNPTFE8
5-0 PTFE, 18" C-17 3/8 Circle Reverse Cut	PSNPTFE9
6-0 PTFE, 18" C-13/8 Circle Reverse Cut Premium	PSNPTFE10
6-0 PTFE, 18" C-3 3/8 Circle Reverse Cut Premium	PSNPTFE11
6-0 PTFE, 18" C-17 3/8 Circle Reverse Cut	PSNPTFE12



Syringes

Ergonomic aspirator designs and various tip diameters allow for precision suction, helping to remove blood and fragments of tissue and bone without obstructing access to the surgical site.



Learn more about our [Syringes](#).



Bulb For Water Syringe

PTISB



Bone Grafting Syringe

7mm

SYBG



Type A Anesthetic Aspirating Syringe

1.8 ml

SYRA

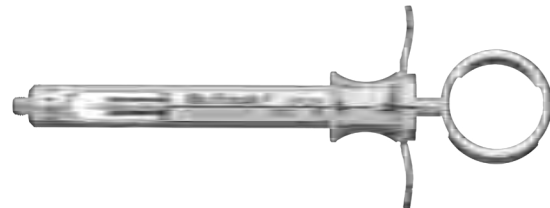

Cook-Waite Anesthetic Aspirating Syringe

1.8 ml

SYRCW

Tissue Pliers

Our selection of Tissue Pliers are designed to grasp and stabilize soft tissue during suturing. Available in plain, 1x2, and multiple teeth, our portfolio offers a variety of designs to accommodate clinician preferences.

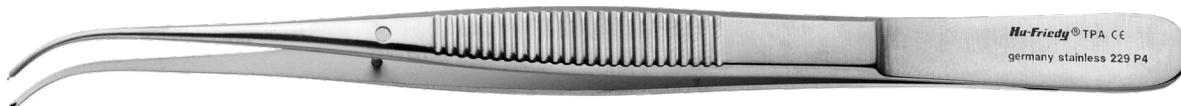

Tissue Plier 1x2, Curved, Fine
14.2 cm **TPA**



16 Hu-Friedy Tissue Pliers
15 cm **TP16**



32 Semkin-Taylor Tissue Pliers
12.5 cm, Straight **TP31**
12.5 cm, Curved **TP32**

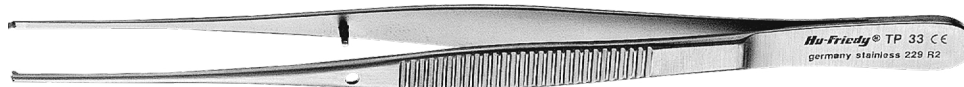

34 Semkin-Taylor Tissue Plier 1x2
12.6 cm, Straight **TP33**
12.6 cm, Curved **TP34**



Tissue Pliers

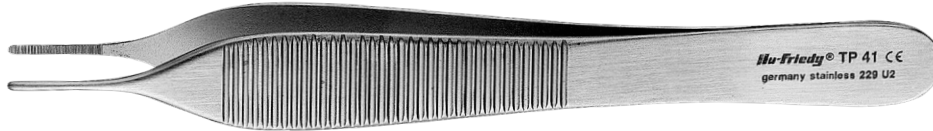

41 Adson Plain Tissue Pliers

12 cm **TP41**



42 Adson 1x2 Tissue Pliers

12 cm **TP42**

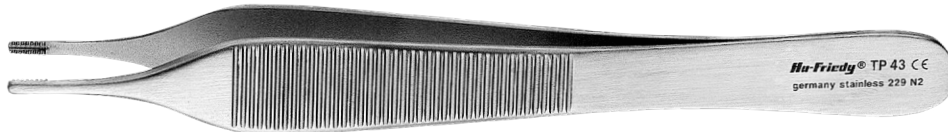

43 Adson-Brown Tissue Pliers

12 cm, Straight **TP43**

12 cm, Angled **TP43A**



50 Fox Tissue Plier

15.24 cm, Locking **TP50L**

15.24 cm, Non-Locking **TP50**



Adson 1x2 Tissue Pliers

15.24 cm **TPA15**

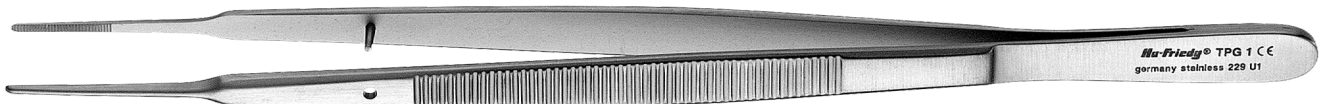

Gerald Tissue Pliers, Straight/Serrated

17.78 cm **TPG1**



Gerald 1x2 Tissue Pliers, Straight
17.78 cm **TPG3**



Gerald 1x2 Tissue Pliers, Curved
17.78 cm **TPG4**



Kramer-Nevins 1x2 Tissue Pliers, Curved
12.5 cm **TPKN**



Adson Micro 1x2 Tissue Pliers
12.2 cm **TPMSA**



Russian Tissue Pliers
15.24 cm **TPR6**

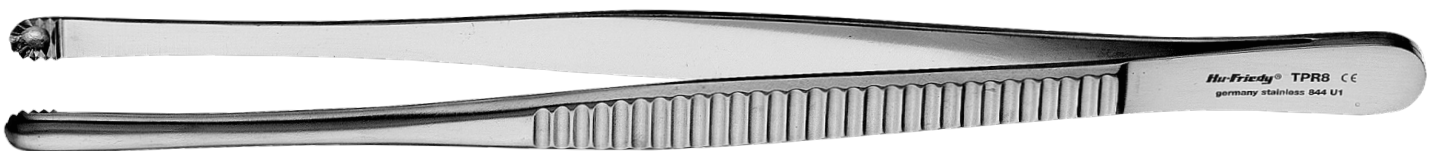

Russian Tissue Pliers
20.32 cm **TPR8**



Corn Suture Pliers



20 Corn Suture Plier
15.24 cm **SP20**



Corn Suture Plier
18 cm **SP20SLEM**

Microsurgical Tissue Pliers

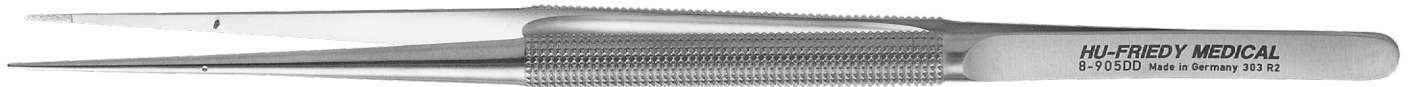

Diamond Dusted Plain Micro Tissue Pliers, Straight
17.78 cm **8-905DD**

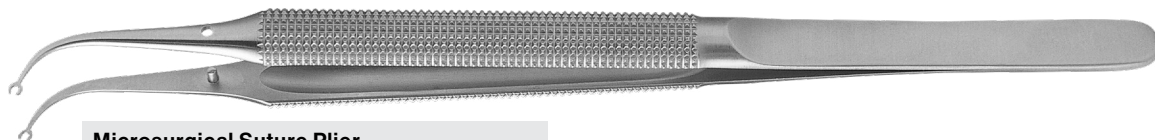

Microsurgical Suture Plier
15 cm **SPM20**



Swiss Perio Microsurgical Plier, Anatomical
18.1 cm **SPTPDAPV**



Swiss Perio Microsurgical Plier, Straight
18.1 cm **SPTPDSSPV**



Titanium Micro Tissue Plier, Straight
18 cm **TPASTMBH**



Anatomic Microsurgical Tissue Plier
18 cm **TPDAPV**



1x2 Curved Diamond Dusted Stainless Steel
17.78 cm **TPDSCPV**



Microsurgical Tissue Plier, Straight
18.1 cm **TPDSSPV**



Schlee Micro Tissue Plier, Straight
18.1 cm **TPSLASCHLE**

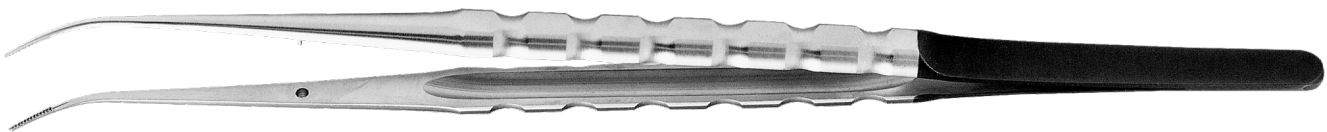

Micro Cooley Tissue Plier, Curved, SinusLine
18 cm **TPSLCOCMN**



Micro Tissue Plier, Straight
17.78 cm **TPSLCOSM**



Micro Schlee Tissue Plier, Straight
17.78 cm **TPSLSSCHLE**



1x2 Diamond Dusted Titanium Tissue Plier,
17.78 cm, Straight **TPSSTMBH**
18 cm, Curved **TPCSTMBH**

Perma Sharp™ Tissue Pliers

Include tungsten carbide beaks.



Adson Perma Sharp™ Tissue Plier
12.07 cm **TP5041**



Adson 1x2 Perma Sharp™ Tissue Plier
12.07 cm **TP5042**

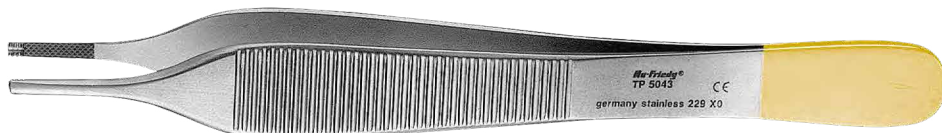

Adson-Brown Perma Sharp™ Tissue Plier
12.07 cm **TP5043**

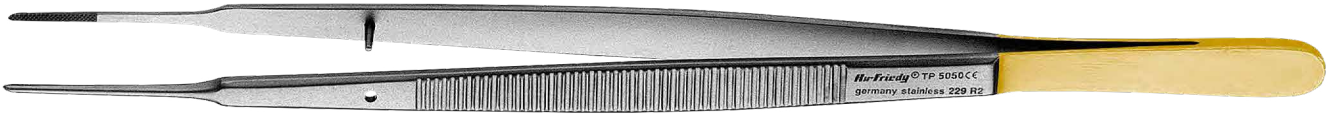

Gerald Perma Sharp™ Tissue Plier
17.78 cm **TP5050**

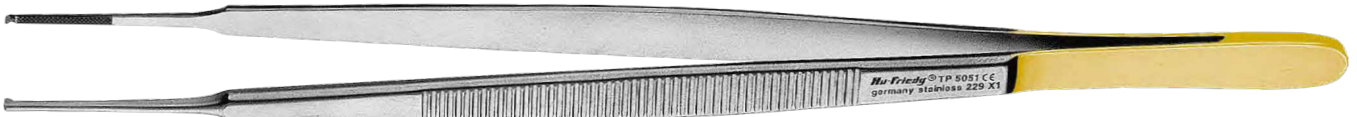

Gerald 1x2 Perma Sharp™ Tissue Plier
17.78 cm **TP5051**



Cushing Perma Sharp™ Tissue Plier
17.78 cm **TP5060**



Cushing Perma Sharp™ Tissue Plier, Angled
17.78 cm **TP5061**



Cushing Bayonet Perma Sharp™ Tissue Plier
19.05 cm **TP5062**

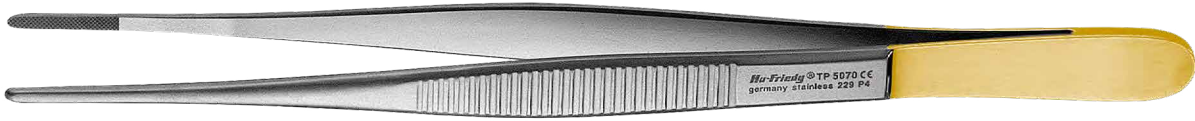

General Perma Sharp™ Tissue Plier

15.24 cm

TP5070



General 1x2 Perma Sharp™ Tissue Plier

15.24 cm

TP5071



Perma Sharp™ Tissue Plier

15.3 cm

TP5072

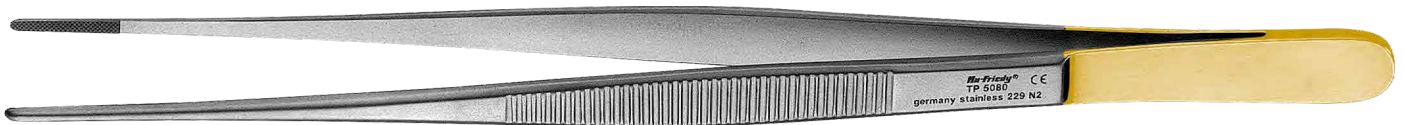

Potts-Smith Perma Sharp™ Tissue Plier

17.78 cm

TP5080



DeBakey Perma Sharp™ Tissue Plier

15.24 cm

TP5090

19.05 cm

TP5091



Tissue Forceps



Allison Baby Tissue Forceps

12.7 cm

TFB



Allison Tissue Forceps

15.24 cm, Straight

TFS



Tissue Nippers

Our selection of Tissue Nippers are designed to separate and/or remove softer tissues during surgical procedures.

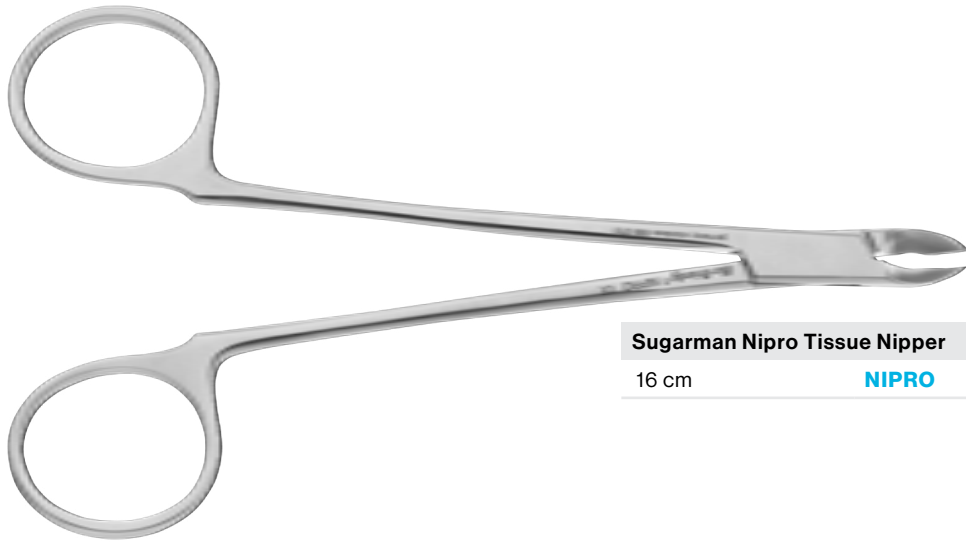

Sugarman Nipro Tissue Nipper

16 cm

NIPRO

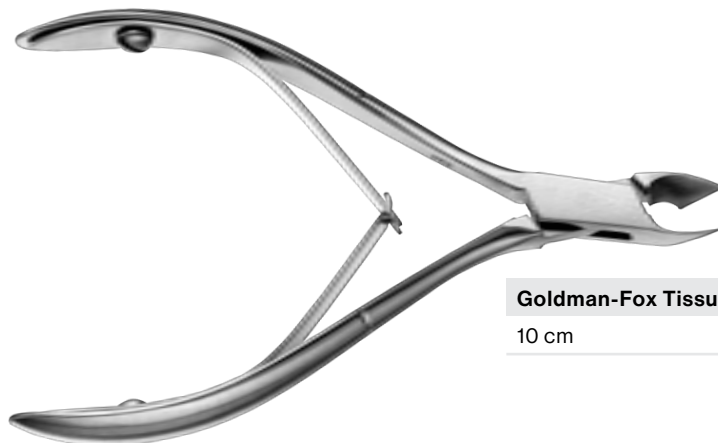

Goldman-Fox Tissue Nippers

10 cm

NIPS

Towel Clamps



Backhaus Towel Clamp

8.26 cm

TC3



Backhaus Towel Clamp

12.7 cm

TC5



Wire Products

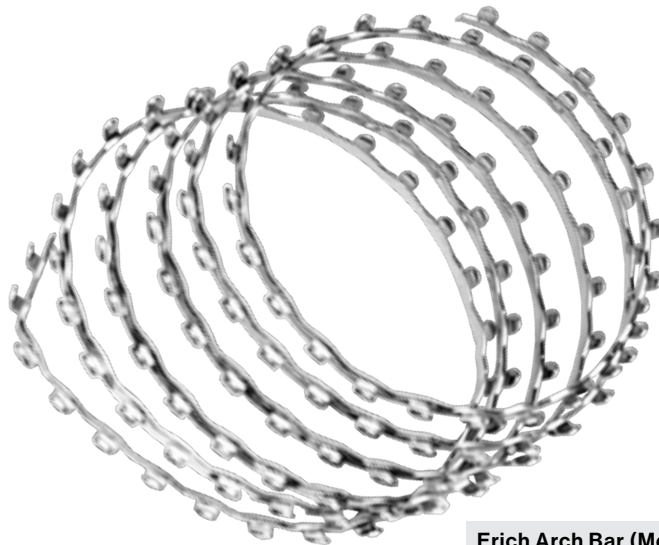

Erich Arch Bar (Meter Coil)

WPAB

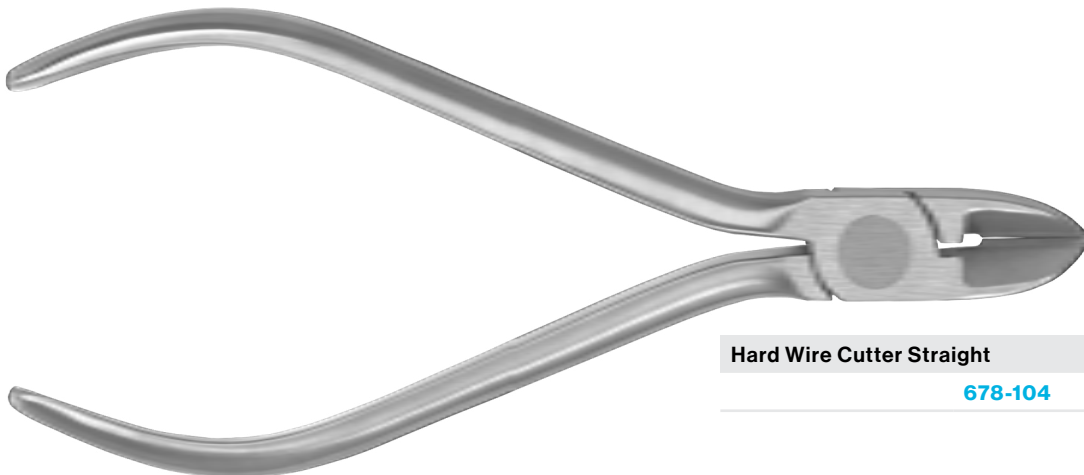

Hard Wire Cutter Straight

678-104

Wire Twisters & Scissors



Wire Cutting Scissors, Angled
Soft wire size max of .38 mm (.015")
12.2 cm **WCS**



Smith Wire Cutting Scissors
Soft wire size max of .38 mm (.015")
15.3 cm **WCSS**

Collections & Kits	A902	Explorers	A929
Additional Collections & Kits	A905	Excavators	A930
Rubber Dam Clamps	A907	Spreaders	A931
Anterior Clamps	A907	Nickel Titanium	A933
Premolar Clamps	A908	Pluggers	A935
General Molar Clamps	A909	Post & Silver Point Removal Forceps	A939
Upper Molar Clamps	A911	Rulers	A941
Lower Molar Clamps	A912	Locking Pliers	A941
Rubber Dam Kits	A913		
Rubber Dam Accessories	A915		
Dental Dams	A917		
Microsurgical	A918		
Velvart Mirrors	A918		
Micro Mirrors	A919		
Mirror Handles	A919		
Curettes	A919		
Explorers	A921		
Pluggers	A922		
Periosteal Elevators	A924		
Excavators	A924		
Condensers/Burnishers	A925		

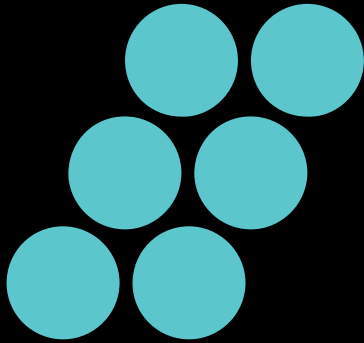

Endodontic

Our extensive line of endodontic hand instruments and accessories, many developed through our ongoing partnerships with Key Opinion Leaders, function as a seamless extension of your skill. From routine root canals to complex microsurgery, our endodontic dental instruments deliver exceptional response, durability, and integrity for a variety of endodontic procedures. The result is outstanding patient care.



Collections & Kits



Our Endodontic portfolio is highlighted by an array of Endodontic Kits and Collections. Specifically curated for a slew of Endodontic procedures with help from our Key Opinion Leaders, these Kits come with all products needed to be **The Best in Practice.**



Learn more about our Key Opinion Leader [Bertrand Khayat](#).

Dr. Bertrand Khayat Endodontic Surgical Kit	IMKHAYAT2
Large Cassette - 20 Instrument, Blue	IM4208
#5 Scalpel Handle	10-130-05E
Mini Scalpel Blade/Mirror Handle Stainless Steel	SHDPV
Micro Mirror Round 3mm	MM4
Khayat Endo Microsurgical Plugger	PLGBK6
Khayat Endo Plastic Filling Instrument	PFI8ABK6
#85 Lucas DE Surgical Curette, #6 Handle	CL856
Velvart Endo Plugger	PLGVEL56
Perma Sharp™ Tissue Pliers	TP5072
PR-3S Prichard Periosteal, #6 Handle	PPR3S6
Columbia 13/14 Curette, #6 Handle	SC13/146
34/35 Mini Jacquette Scaler, #6 Handle	SJ34/356
89/92 Discoid-Cleoid Carver, #6 Handle	CD89/926
DG16/17 DE Endo Explorer, #6 Handle	EXDG16/176
Cawood-Minnesota Retractor	CRM2
Perma Sharp™ Castro Needle Holder, Curve Round	NH5021RC
#14 LaGrange Scissors, Super Cut	S14SC

Basic Endodontic Kit	ENDOKIT
#6 Cone Socket Mirror Handle	MH6
#4 Front Surface Rhodium Single-Sided Mirror	MIR4
1 Endo Locking Pliers	EPL1
DG16 DE Endo Explorer, Black Line	EXDG16X
31L DE Endo Excavator, Black Line	EXC31LX
D11NT SE Root Canal Spreader	RCS11NT
1/3 DE Root Canal Plugger, Black Line	RCP1/3X
5/7 DE Root Canal Plugger, Black Line	RCP5/7X
9/11 DE Root Canal Plugger, Black Line	RCP9/11X
1 DE Glick Plastic Plugger, Black Line	RCPGL1X
Special Signature Series Cassette - 10-Instrument, Black	IM5107



Prof. Elio Berutti and Prof. Damiano Pasqualini Microsurgical Endo Kit	BPMEKIT
Berutti Pasqualini Explorer/Debrider	MBP-EX1
Berutti Pasqualini Elevator	MBP-E1
Berutti Pasqualini Plugger, 0.5mm & 0.7mm	MBP-PLG1
Berutti Pasqualini Plugger, 0.5mm	MBP-PLG2
Berutti Pasqualini Plugger, 0.7mm	MBP-PLG3
Berutti Pasqualini Curette	MBP-C1
Berutti Pasqualini Burnisher, 1.4mm	MBP-CB1
Columbia Cheek Retractor	CRC
#23 Seldin Periosteal	P23
Cooley Micro Tissue Pliers, Multiple Teeth, Straight, 18cm (7")	TPSLCOSM
Goldman-Fox, Straight, Super-Cut, Black Line, 13.5cm (5-1/4")	S20SCX
Needle Holder, Fine Swedish Pattern, Perma Sharp™, 15cm (6")	NH5052
2 Kelly Hemostat, Curved	H2
Microsurgical Mini Scalpel Blade/Mirror Handle, Stainless Steel	SHDPV
Microsurgical Mini Scalpel Blade/Mirror Handle, Stainless Steel	SHDPV
Micro Mirror, Round, 3mm	MM4
Infinity Series™ Cassette - 16 Instrument Cassette	IMN4167
2-Pack Signature Series™ Hinged Instrument Clip	IM1000
2-Pack Signature Series™ Hinged Instrument Clip	IM1000
2-Pack Signature Series™ Hinged Instrument Clip	IM1000

Prof. Elio Berutti and Prof. Damiano Pasqualini Essential Microsurgical Endo Kit	BPEMEKIT
Berutti Pasqualini Elevator	MBP-E1
Berutti Pasqualini Apical Explorer/Debrider	MBP-EX1
Berutti Pasqualini Plugger, 0.5mm & 0.7mm	MBP-PLG1
Berutti Pasqualini Plugger, 0.5mm	MBP-PLG2
Berutti Pasqualini Plugger, 0.7mm	MBP-PLG3
Berutti Pasqualini Curette	MBP-C1
Berutti Pasqualini Burnisher, 1.4mm	MBP-CB1
Infinity Series™ Cassette - 8 Instrument, Black	IMN5087

Dr. Adham Azim Microsurgical Endo Kit	AZIMENDOKIT
Microsurgical Scalpel Handle/Steel	SHDPV
Scalpel Handle No. 5	10-130-05E
#13/14 Columbia Curette, Satin Steel	SC13/146
#85 Lucas DE Surgical Curette #6 Handle	CL856
#86 Lucas DE Surgical Curette #6 Handle	CL866
Velvart Endo MS Plugger	PLGVEL56
Universal Micro-Condenser/Burnisher, Lg	MCBUL
Khayat Endo MS Plugger 4.5mm/6.0mm	PLGBK6
#DG16/17 DE Endo Explorer Satin Stl Hdl	EXDG16/176
Khayat Endodontic Plastic Filling Inst	PF18ABK6
#7 Mini Scalpel Blade Holder	10-130-70
Micro Mirror 7mm x 2mm	MM7
Cawood-Minnesota Retractor	CRM2
Perm Sharp Castro Needle Holder, Crv Rnd	NH5021RC
Perma Sharp Tissue Pliers	TP5072
INFINITY 20 Inst Cassette, Gray	IMN4201



Learn more about the **Berutti Pasqualini Microsurgical Endo Kit**



Chivian-Arens Endo Surgery Kit	ENDO-SXKIT
#85 Lucas DE Surgical Curette, #6 Handle	CL85
87 Lucas DE Surgical Curette	CL87
#2/4 Molt DE Curette	CM2/4
#1 DE Explorer	EXD1
Mathieu-Kocher Perma Sharp™ Needle Holder	NH5074
#1 Hourigan Periosteal	PH1
#149 Periosteal Elevator	P149
Columbia 13/14 Curette, #6 Handle	SC13/14
Indiana University 17/18 Curette	SIU17/18
18 Curved Iris Scissors	S18
Modified Serrated Minnesota Retractor	CRMT
#23/UNC15 Expro	XP23/UNC15
#5 Scalpel Handle, Round Straight	10-130-05

Dr. Ralan Wong Kit	KIT-WONG
#4 Front Surface Rhodium Single-Sided Mirror	MIR4
#6 Cone Socket Mirror Handle (QTY: 2)	MH6
#5 Front Surface Rhodium Single-Sided Mirror	MIR5
Qulix SE Probe, 3-6-9-12, #6 Handle	PCP126
DG16 DE Endo Explorer	EXDG16
18L Locking Dressing Plier	DP18L
#9 Molt Periosteal Elevator	P9
#23 Seldin Periosteal Retractor	P23
Gracey 1/2 Curette, #9 Handle	SG1/29E2
Woodson Periosteal	PFIWDS1
31L DE Endo Excavator	EXC31L
33L DE Endo Excavator	EXC33L
#10 Miller DE Surgical Curette	CM10
#11 Miller DE Surgical Curette	CM11
#12 Miller DE Surgical Curette	CM12
#42 Adson 1x2 Tissue Pliers	TP42
#18 Iris Scissors, Curved	S18
Perma Sharp™ Hegar-Baumgar Needle Holder	NH5034
Large Cassette - 16 Instrument, Blue	IM4168

Dr. Thomas Von Arx Kit	KIT-VON
#5 Scalpel Handle	10-130-05E
Micro Mirror 3 mm x 9 mm	MM8
Mini Scalpel Blade/Mirror Handle Stainless Steel	SHDPV
Apical Explorer, #6 Handle	MEX16
Titanium Micro Tissue Pliers, Straight	TPASTMBH
#84 Lucas DE Surgical Curette, #6 Handle	CL846
#86 Lucas DE Surgical Curette, #6 Handle	CL866
Buser Periosteal, #6 Handle	PPBUSER6
#3/9A Periosteal, #6 Handle	PPR3/9A6
8A Composite Instrument	TNPF18A
5 Novatech Long/Fluted	CSNT5
Crile-Wood Perma Sharp™ Needle Holder	NH5038
Kelly Perma Sharp™ Scissors, 6.25" Curved	S5001
Large Left Micro-Condenser/Burnisher	MCBLL
Medium Left Micro-Condenser/Burnisher	MCBLM
Medium Right Micro-Condenser/Burnisher	MCBRM
Small Left Micro-Condenser/Burnisher	MCBLS
Small Right Micro-Condenser/Burnisher	MCBRS
Large Right Micro-Condenser/Burnisher	MCBRL
5 Abou-Rass Angled Burnisher	MAR-B5
Hartmann Hemostat, 4" Straight	HHS
Kocher Hemostat, 5.5" Curved	HKC
Oral Surgery Signature Series Cassette - 20 Instrument, Gray	IMOS201NC8
Hinged Instrument Clips, 2 Pack	IM1000

Additional Collections & Kits

Prof. Marwan Abou-Rass Microsurgical Endo Instrument Recommendations

Large Cassette - 16 Instrument, Blue	IM4168
Hinged Instrument Clips, 2 Pack	IM1000
#9 Molt Periosteal Elevator	P9
#1 Henahan Retractor, Left	TRH1
3 Abou-Rass Endo Excavator DE	MAR-C3
3 Abou-Rass Apical Surgical Curette SE	MAR-SC3
1 Abou-Rass Endo Explorer DE	MAR-EX1
DG16/17 DE Endo Explorer	EXDG16/17
1 Abou-Rass Straight Apical Condenser	MAR-SAC1
1 Abou-Rass Angulated Apical Condenser	MAR-AAC1
3 Abou-Rass Straight Burnisher	MAR-SB3
3 Abou-Rass Angled Burnisher	MAR-B3
#50L Fox Tissue Pliers w/Lock	TP50L
1 Velvart	MMVEL1
2 Velart	MMVEL2
Metzenbaum Perma Sharp™ Scissors, Curved/Blunt	S5055
Crile-Wood Perma Sharp™ Needle Holder	NH5038
Perma Sharp™ Halsey Needle Holder, Serrated	NH5037
4 Kramer-Nevins DE Curette	SKN4

Dr. Rainer Hahn Microsurgical Endo Instrument Recommendations

Large Cassette - 16 Instrument, Blue	IM4168
Castro Microsurgical Scissors	SPV
Micro Cooley SinusLine Curved Tissue Plier	TPSLCOCMN
Microsurgical Needle Holder	NHDPV
Mini Scalpel Blade/Mirror Handle	SHDPV
Periosteal PH2MBH	PH26M
Pr. Spahr Papilla Periosteal, #6 Handle	PPSPAHR6
Mini Scalpel Blade 69 FRE Box of 12	MB69
Labanca Periosteal, #6 Handle	PPLABANCA6

Dr. Peter Velvart Endo Microsurgical Instrument Recommendations

Large Cassette - 16 Instrument, Blue	IM4168
Micro Mirror Round 3mm	MM4
Micro Mirror Round, 5mm	MM5
Micro Mirror Round, 2mm x 7mm	MM7
Micro Mirror 3 mm x 9 mm	MM8
Microsurgical Needle Holder	NHDPV
Mini Scalpel Blade/Mirror Handle Stainless Steel	SHDPV
Mini Scalpel Blade 67 Box of 12	MB67
Mini Scalpel Blade 69 FRE Box of 12	MB69
Castro Microsurgical Scissors	SPV
Anatomic Microsurgical Tissue Pliers	TPDAPV
Microsurgical Tissue Pliers, Curved	TPDSCPV
Microsurgical Tissue Pliers, Straight	TPDSSPV

Dr. Pierre Machtou Endo Pre-Treatment Instrument Recommendations

Large Cassette - 16 Instrument, Blue	IM4168
Hinged Instrument Clips, 2 Pack	IM1000
IMS™ Bur Cushion, Short Lid	IMS-1372S
Articulation Paper Pliers, European	APF2E
3S Hollenback, #6 Handle	CVHL3S6
U17 Utility Pick-up Dressing Pliers	DPU17
32L DE Endo Excavator, #6 Handle	EXC32L6
#6L SE Explorer	EXS6XL
1 Kelly Hemostat, Straight	H1
#5 Front Surface Rhodium Single-Sided Mirror	MIR5
#6 Simple Stem European Mirror Handle	MHE6
Qulix SE UNC Probe, 1-15, #6 Handle	PCPUNC156
2 Loesche, #6 Handle	PFIGML26
Rubber Dam Frame, Adult	RDAF6
Rubber Dam Clamp #1	RDCM1
Rubber Dam Clamp #212	RDCM212
Rubber Dam Clamp #26N	RDCM26N
Rubber Dam Clamp #4	RDCM4
Rubber Dam Clamp #8	RDCM8
Rubber Dam Clamp #9	RDCM9
Rubber Dam Clamp #W8A	RDCMW8A
Rubber Dam Forceps #4	RDF4
#17 Iris Scissors, Straight	S17
204SD Posterior Sickle Scaler, #6 Handle	S204SD6
Cook-Waite Anesthetic Aspirating Syringe, 1.8ml	SYRCW



Dr. Pierre Machtou Endo Treatment Instrument Recommendations

Large Cassette - 16 Instrument, Blue	IM4168
IMS™ Large Parts Box	IMS-1273
A6 Rigid, #6 Handle	CSA6
#1 Dressing Pliers (Perry)	DP1
DG16 DE Endo Explorer, #7 Handle	EXDG167
5 European Front Surface Mouth Mirror, 12 pack	M5C
#6 Simple Stem European Mirror Handle	MHE6
10 SE Root Canal Plugger	RCP10
11 SE Root Canal Plugger	RCP11
8 SE Root Canal Plugger	RCP8
9 SE Root Canal Plugger	RCP9
1/2 Machtou Root Canal Plugger	RCPM1/2
3/4 Machtou Root Canal Plugger	RCPM3/4
D11T Root Canal Spreader	RSCD11T
#17 Iris Scissors, Straight	S17

Dr. Richard Schwartz Endo Kit **KIT-SCHWARTZ**

1/2 Hollenback, #6 Handle	CVHL1/26
2 College Dressing Pliers	DP2
18 Excavator, #6 Handle	EXC186
DG16 DE Endo Explorer, #6 Handle	EXDG166
2 Kelly Hemostat, Curved	H2
#7 Cone Socket Mirror Handle	MH7
#4 Front Surface Rhodium Single-Sided Mirror	MIR4
Micro Mirror Round, 5mm	MM5
3R Modified P.K. Thomas Waxing #6	PKT3RM6
# 0/1 Serrated Marquette Condenser, #6	PLG0/16
#9 SE Root Canal Plugger	RCP9
Rubber Dam Clamp #212	RDCM212
Rubber Dam Clamp #3	RDCM3
Rubber Dam Clamp #W2	RDCMW2
Rubber Dam Clamp #W8A	RDCMW8A
Rubber Dam Forceps	RDF
Rubber Dam Punch, Ainsworth	RDPA
Crown & Gold Scissors, Curved	SCGC
Goldstein Flexi-Thin, #1	TNCIGFT1
IMS™ Small Parts Box	IMS-1271
Large Cassette - 16 Instrument, Green	IM4169

Endodontic Infinity Kit

Large Cassette with Accessory Area - 12 Instrument, Gray	IMN4121 or IMEDIN131
#6 Cone Socket Mirror Handle	MH6
#4 Front Surface Rhodium Single-Sided Mirror	MIR4
DG16 DE Endo Explorer, #6 Handle	EXDG166
1 Endo Locking Pliers	EPL1
31L DE Endo Excavator, #6 Handle	EXC31L6
D11NT SE Root Canal Spreader	RCS11NT
1/3 DE Root Canal Plugger	RCP1/3
5/7 DE Root Canal Plugger	RCP5/7
9/11 DE Root Canal Plugger	RCP9/11
1 DE Glick Plastic Plugger	RCPGL1
Miller Articulating Paper Forceps	APF2
Cook-Waite Anesthetic Aspirating Syringe, 1.8ml	SYRCW
Rubber Dam Clamp #1	RDCM1
Rubber Dam Clamp #2	RDCM2
Rubber Dam Clamp #9	RDCM9
Rubber Dam Clamp #26N	RDCM26N
IMS™ Endodontic Stand - Holds 24	IMS-1275
IMS™ Small Parts Box	IMS-1271
IMS™ Bur Cushion, Short Lid	IMS-1372S
Signature Series™ Air/Water Clip	IM1005

Endodontic Infinity Kit 2

Large Cassette with Accessory Area - 12 Instrument, Gray	IMN4121 OR IMEDIN131
#6 Cone Socket Mirror Handle	MH6
#4 Front Surface Rhodium Single-Sided Mirror	MIR4
#5 DE Explorer	EXD5
Qulix SE Probe, 3-6-9-12	PCP12
DG16 DE Endo Explorer	EXDG16
1 Endo Locking Pliers	EPL1
31L DE Endo Excavator	EXC31L
D11T SE Root Canal Spreader	RCS11T
5/7 DE Root Canal Plugger	RCP5/7
1 DE Glick Plastic Plugger	RCPGL1
IMS™ Bur Cushion, Short Lid	IMS-1372S
IMS™ Small Parts Box	IMS-1271
Rubber Dam Clamp #1	RDCM1
Rubber Dam Clamp #2	RDCM2
Rubber Dam Clamp #9	RDCM9
Rubber Dam Clamp #26N	RDCM26N
Miller Articulating Paper Forceps	APF2

Rubber Dam Clamps

Our Rubber Dam Clamps are made from proprietary Satin Steel™ Alloy for corrosion resistance, superior strength, and a fine balance between flexibility and memory. Their matte finish absorbs and dissipates light instead of reflecting it back, so you can experience a comfortable field of vision that is easier on the eyes — to help you be **The Best in Practice**.



Easily identify the perfect **Rubber Dam Clamp** for your procedure with our interactive **Pick Your Perfect Clamp Tool**.

Anterior Clamps



Rubber Dam Clamp #B4
Anterior incisors and canines.
 Black Line **RDCMB4X**
 Satin Steel™ Alloy **RDCMB4**

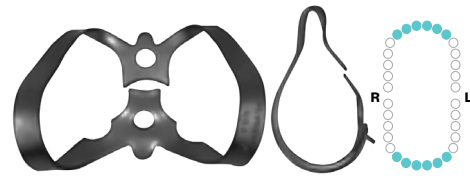

Rubber Dam Clamp #6
Slightly offset jaws for labial caries on anterior teeth.
 Black Line **RDCM6X**
 Satin Steel™ Alloy **RDCM6**



Rubber Dam Clamp #9
Offset flat jaws and stiff bow for anterior teeth.
 Black Line **RDCM9X**
 Satin Steel™ Alloy **RDCM9**



Rubber Dam Clamp #9S
Offset flat serrated jaws for anterior teeth.
 Black Line **RDCM9SX**
 Satin Steel™ Alloy **RDCM9S**



Rubber Dam Clamp #212
Flat jaws for labial caries on anterior teeth.
 Black Line **RDCM212X**
 Satin Steel™ Alloy **RDCM212**



Rubber Dam Clamps #212SA
Slightly offset staggered jaws for odd shaped anteriors.
 Black Line **RDCM212SAX**
 Satin Steel™ Alloy **RDCM212SA**



Rubber Dam Clamps



Rubber Dam Clamp #106R

Anterior Region.

Black Line **RDCM106RX**

Satin Steel™ Alloy **RDCM106R**



Rubber Dam Clamp #106L

Anterior Region.

Black Line **RDCM106LX**

Satin Steel™ Alloy **RDCM106L**

Premolar Clamps



Rubber Dam Clamp #0

Flat jaws and high bow for longer premolars.

Black Line **RDCM0X**

Satin Steel™ Alloy **RDCM0**



Rubber Dam Clamp #1

Slightly festooned jaws for upper premolars.

Black Line **RDCM1X**

Satin Steel™ Alloy **RDCM1**

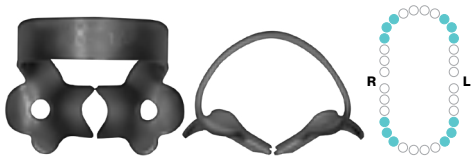

Rubber Dam Clamp #1A

Deeply festooned jaws for canines and premolars.

Black Line **RDCM1AX**

Satin Steel™ Alloy **RDCM1A**



Rubber Dam Clamp #2

Flat jaws for premolars.

Black Line **RDCM2X**

Satin Steel™ Alloy **RDCM2**

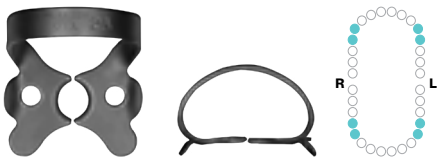

Rubber Dam Clamp #2A

Flat jaws for larger premolars.

Black Line **RDCM2AX**

Satin Steel™ Alloy **RDCM2A**



Rubber Dam Clamp #2AS

Flat serrated jaws for larger premolars.

Black Line **RDCM2ASX**

Satin Steel™ Alloy **RDCM2AS**



Rubber Dam Clamp #W2

Flat jaws for premolars.

Black Line **RDCMW2X**

Satin Steel™ Alloy **RDCMW2**



Rubber Dam Clamp #27N

Slightly festooned jaws for premolars.

Black Line **RDCM27NX**

Satin Steel™ Alloy **RDCM27N**

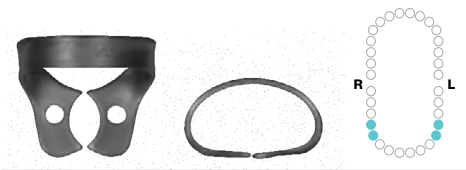

Rubber Dam Clamp #29
Flat jaws for lower premolars.

Black Line	RDCM29X
Satin Steel™ Alloy	RDCM29



Rubber Dam Clamp #209
Small, flat jaws with stiff bow for lower premolars.

Black Line	RDCM209X
Satin Steel™ Alloy	RDCM209



Rubber Dam Clamp #00
Flat jaws and high bow for small lower canines and first premolars.

Black Line	RDCM00X
Satin Steel™ Alloy	RDCM00

General Molar Clamps

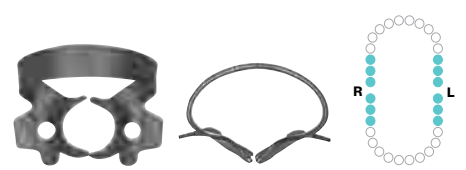

Rubber Dam Clamp #8A
Deeply festooned four-point jaws for molars.

Black Line	RDCM8AX
Satin Steel™ Alloy	RDCM8A



Rubber Dam Clamp #8AD
Deeply festooned jaws and extended bow for distal access to molars.

Black Line	RDCM8ADX
Satin Steel™ Alloy	RDCM8AD



Rubber Dam Clamp #W8A
Slightly festooned jaws for molars.

Black Line	RDCMW8AX
Satin Steel™ Alloy	RDCMW8A



Rubber Dam Clamp #10
Flat jaws designed for small upper left and lower right molars; paired with RDCM11.

Black Line	RDCM10X
Satin Steel™ Alloy	RDCM10



Rubber Dam Clamps



Rubber Dam Clamp #11

Flat jaws designed for small upper right and lower left molars; paired with RDCM10.

Black Line **RDCM11X**

Satin Steel™ Alloy **RDCM11**



Rubber Dam Clamp #14

Deeply festooned jaws for partially erupted or irregularly shaped molars.

Black Line **RDCM14X**

Satin Steel™ Alloy **RDCM14**

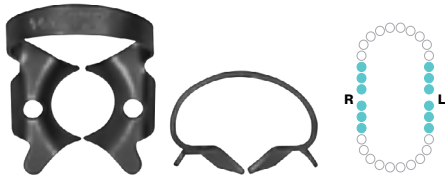

Rubber Dam Clamp #14A

Deeply festooned jaws for partially erupted or irregularly shaped molars; larger than RDCM14.

Black Line **RDCM14AX**

Satin Steel™ Alloy **RDCM14A**



Rubber Dam Clamp #W14A

Deeply festooned jaws for partially erupted or irregularly shaped molars.

Black Line **RDCMW14AX**

Satin Steel™ Alloy **RDCMW14A**



Rubber Dam Clamp #18

Flat jaws and stiff bow for molars.

Black Line **RDCM18X**

Satin Steel™ Alloy **RDCM18**



Rubber Dam Clamp #27

Flat jaws for large molars.

Black Line **RDCM27X**

Satin Steel™ Alloy **RDCM27**



Rubber Dam Clamp #56

Slightly festooned jaws for large molars.

Black Line **RDCM56X**

Satin Steel™ Alloy **RDCM56**



Rubber Dam Clamp #56S

Slightly festooned serrated jaws for large partially erupted or irregularly shaped molars.

Black Line **RDCM56SX**

Satin Steel™ Alloy **RDCM56S**

Upper Molar Clamps



Rubber Dam Clamp #4
Flat narrow jaws for small upper molars.
 Black Line **RDCM4X**
 Satin Steel™ Alloy **RDCM4**

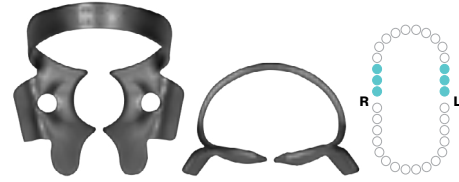

Rubber Dam Clamp #W4
Flat narrow jaws for small upper molars.
 Black Line **RDCMW4X**
 Satin Steel™ Alloy **RDCMW4**



Rubber Dam Clamp #5
Slightly festooned jaws for large upper molars.
 Black Line **RDCM5X**
 Satin Steel™ Alloy **RDCM5**



Rubber Dam Clamp #8
Deeply festooned jaws for upper molars.
 Black Line **RDCM8X**
 Satin Steel™ Alloy **RDCM8**



Rubber Dam Clamp #26N
Flat jaws for upper molars.
 Black Line **RDCM26NX**
 Satin Steel™ Alloy **RDCM26N**



Rubber Dam Clamp #30
Offset jaws for upper right molars; paired with RDCM31.
 Black Line **RDCM30X**
 Satin Steel™ Alloy **RDCM30**



Rubber Dam Clamp #31
Offset jaws for upper left molars; paired with RDCM30.
 Black Line **RDCM31X**
 Satin Steel™ Alloy **RDCM31**

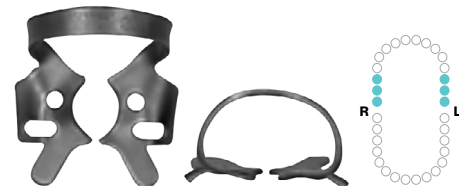

Rubber Dam Clamp #201
Slightly festooned jaws for upper molars.
 Black Line **RDCM201X**
 Satin Steel™ Alloy **RDCM201**



Rubber Dam Clamp #205
Slightly festooned jaws for large upper molars.
 Black Line **RDCM205X**
 Satin Steel™ Alloy **RDCM205**



Lower Molar Clamps



Rubber Dam Clamp #24

Flat jaws for upper right and lower left molars; paired with RDCM25.

Black Line **RDCM24X**
Satin Steel™ Alloy **RDCM24**



Rubber Dam Clamp #25

Flat jaws for upper left and lower right molars; paired with RDCM24.

Black Line **RDCM25X**
Satin Steel™ Alloy **RDCM25**



Rubber Dam Clamp #3

Flat narrow jaws for small lower molars.

Black Line **RDCM3X**
Satin Steel™ Alloy **RDCM3**



Rubber Dam Clamp #W3

Flat narrow jaws for small lower molars.

Black Line **RDCMW3X**
Satin Steel™ Alloy **RDCMW3**



Rubber Dam Clamp #7

Flat jaws for lower molars.

Black Line **RDCM7X**
Satin Steel™ Alloy **RDCM7**

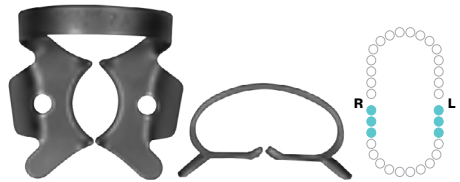

Rubber Dam Clamp #7A

Slightly reversed festooned jaws for large lower molars.

Black Line **RDCM7AX**
Satin Steel™ Alloy **RDCM7A**



Rubber Dam Clamp #W7

Flat jaws for lower molars.

Black Line **RDCMW7X**
Satin Steel™ Alloy **RDCMW7**



Rubber Dam Clamp #12A

Serrated offset jaws for lower right molars; paired with RDCM13A.

Black Line **RDCM12AX**
Satin Steel™ Alloy **RDCM12A**



Rubber Dam Clamp #13A
Serrated offset jaws for lower left molars; paired with RDCM12A.

Black Line	RDCM13AX
Satin Steel™ Alloy	RDCM13A

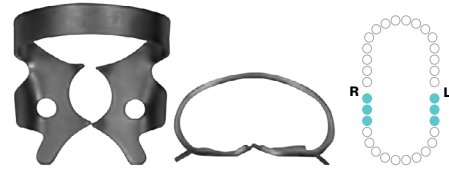

Rubber Dam Clamp #26
Slightly reversed festooned jaws for small lower molars.

Black Line	RDCM26X
Satin Steel™ Alloy	RDCM26



Rubber Dam Clamp #28
Flat jaws for lower molars.

Black Line	RDCM28X
Satin Steel™ Alloy	RDCM28



Learn more about our **Rubber Dam Clamps and Accessories.**

Rubber Dam Kits

Our Rubber Dam Clamps are not only available separately, they are also available in sets and kits. Popular and commonly used Rubber Dam Clamps are bundled together for ease and convenience. Rubber Dam Clamp Kits options are also available that include accessories.

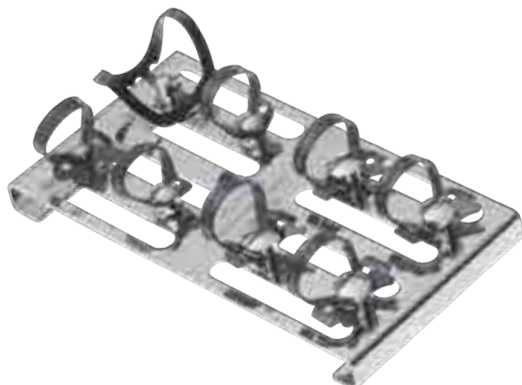

Black Line Rubber Dam Clamp Kit	RDCKITX
Rubber Dam Clamp #13A, Black Line	RDCM13AX
Rubber Dam Clamp #12A, Black Line	RDCM12AX
Rubber Dam Clamp #27N, Black Line	RDCM27NX
Rubber Dam Clamp #W8A, Black Line	RDCMW8AX
Rubber Dam Clamp #212, Black Line	RDCM212X
Rubber Dam Clamp #14, Black Line	RDCM14X
Rubber Dam Clamp #2A, Black Line	RDCM2AX
Rubber Dam Clamp #26, Black Line	RDCM26X
Rubber Dam Clamp Organizing Board	RDCOB

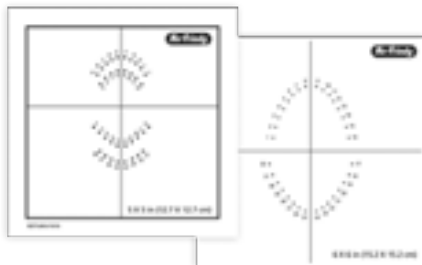

Satin Steel™ Rubber Dam Clamp Set	RDCSET
Rubber Dam Clamp #0, Satin Steel™ Alloy	RDCM0
Rubber Dam Clamp #1, Satin Steel™ Alloy	RDCM1
Rubber Dam Clamp #14A, Satin Steel™ Alloy	RDCM14A
Rubber Dam Clamp #2, Satin Steel™ Alloy	RDCM2
Rubber Dam Clamp #212, Satin Steel™ Alloy	RDCM212
Rubber Dam Clamp #7, Satin Steel™ Alloy	RDCM7
Rubber Dam Clamp #8, Satin Steel™ Alloy	RDCM8
Rubber Dam Clamp #8A, Satin Steel™ Alloy	RDCM8A

Rubber Dam Clamp Set 7	RDCSET7
Rubber Dam Clamp #00, Satin Steel™ Alloy	RDCM00
Rubber Dam Clamp #2, Satin Steel™ Alloy	RDCM2
Rubber Dam Clamp #7, Satin Steel™ Alloy	RDCM7
Rubber Dam Clamp #8, Satin Steel™ Alloy	RDCM8
Rubber Dam Clamp #8A, Satin Steel™ Alloy	RDCM8A
Rubber Dam Clamp #9, Satin Steel™ Alloy	RDCM9
Rubber Dam Clamp #14A, Satin Steel™ Alloy	RDCM14A

Rubber Dam Kit	RDKIT
Rubber Dam Forceps	RDF
Rubber Dam Punch	RDP
Rubber Dam Frame, Adult	RDAF6
Universal Rubber Dam Template	RDTUNIV
FDI Rubber Dam Template	RDTFDI
Rubber Dam Clamp Organizing Board	RDCOB
Rubber Dam Clamp #0, Satin Steel™ Alloy	RDCM0
Rubber Dam Clamp #1, Satin Steel™ Alloy	RDCM1
Rubber Dam Clamp #2, Satin Steel™ Alloy	RDCM2
Rubber Dam Clamp #7, Satin Steel™ Alloy	RDCM7
Rubber Dam Clamp #8, Satin Steel™ Alloy	RDCM8
Rubber Dam Clamp #8A, Satin Steel™ Alloy	RDCM8A
Rubber Dam Clamp #14A, Satin Steel™ Alloy	RDCM14A
Rubber Dam Clamp #212, Satin Steel™ Alloy	RDCM212

Rubber Dam Accessories

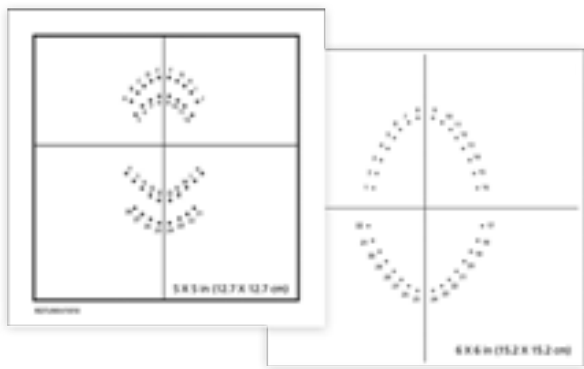

Universal Rubber Dam Template
 6" x 6" (15.2cm x 15.2cm)
 Adult template shown.
 Pedodontic template also included. Plastic printed.
RDUNIV

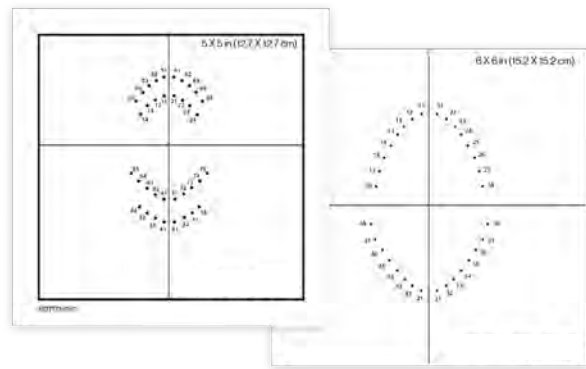

FDI Rubber Dam Template
 6" x 6" (15.2cm x 15.2cm)
 Adult template shown.
 Pedodontic template also included. Vinyl printed.
RDTFDI



Rubber Dam Punch, Ainsworth
 6.75" (17.5cm)
RDPA

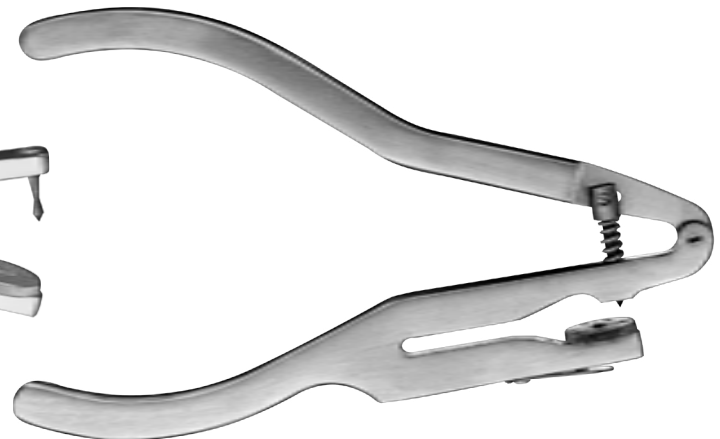

Rubber Dam Punch
 6.75" (16cm)
RDP

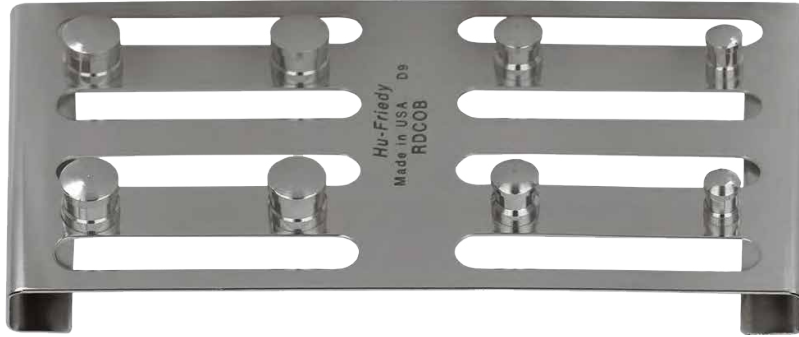

Rubber Dam Clamp Organizing Board

4.62" x 2.4" x .375" (11.7 cm x 6.1 cm x 1 cm)

Store, sterilize and organize with eight pegs that securely hold your clamps. Clamps not included.

RDCOB

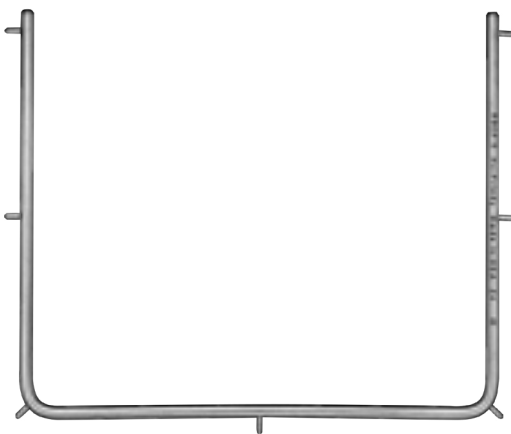

Rubber Dam Frame

Child - 5" (13cm)

RDCF5



Rubber Dam Frame

Adult - 6" (15cm)

RDAF6

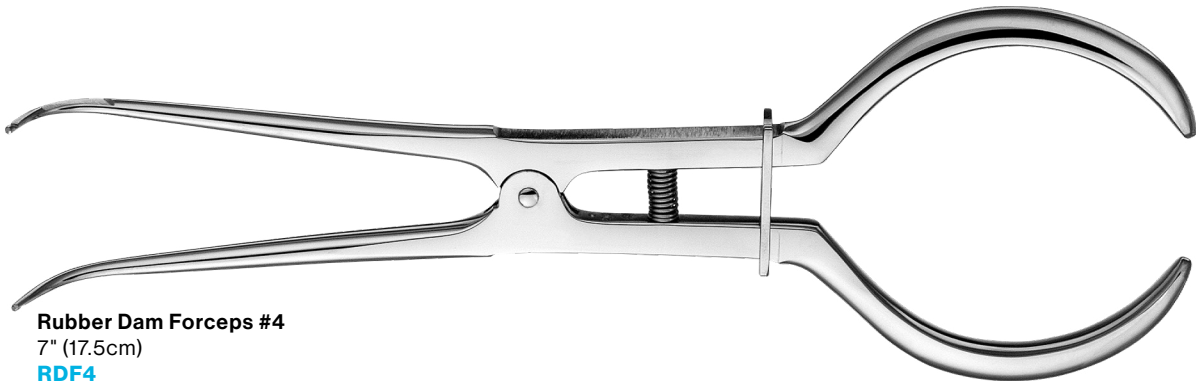

Rubber Dam Forceps #4

7" (17.5cm)

RDF4



Rubber Dam Forceps

6.5" (17cm)

RDF

Dental Dams

Our Dental Dams, available in flavors such as mint and peppermint, keep your field of operation dry for best treatment outcomes. Available in Latex, Non-Latex and Powder Free options.



Learn more about our [Dental Dams](#).



Dental Dam
Non-Latex, Powder-Free/Low Protein, Peppermint
 6" x 6" - 15 per box
 Medium **19500**



Dental Dam
Non-Latex, Light Blue, Peppermint
 6" x 6" - 15 per box
 Medium **19600**



Dental Dam
Latex, Powder-Free/Low Protein, Unflavored
 5" x 5" - 52 per box
 Thin **19102**
 Medium **19100**
 Heavy **19101**
 6" x 6" - 36 per box
 Thin **19302**
 Medium **19300**
 Heavy **19301**



Dental Dam
Latex, Black, Unflavored
 5" x 5" - 52 per box
 Thin **19702**
 Medium **19700**
 Heavy **19701**
 6" x 6" - 36 per box
 Thin **19802**
 Medium **19800**
 Heavy **19801**



Dental Dam
Latex, Powder-Free/Low Protein, Mint
 5" x 5" - 52 per box
 Thin **19202**
 Medium **19200**
 Heavy **19201**
 6" x 6" - 36 per box
 Thin **19402**
 Medium **19400**
 Heavy **19401**



Microsurgical

Made from highly polished stainless steel, come in round or rectangular shapes, are single or double-ended, and are offered in a variety of sizes.



Learn more about our line of [Microsurgical Instruments](#).

Velvart Mirrors

The following mirrors are concave.



2 x 7 mm



1 Small Rectangular

Round, 1 Ring **MM1**



3 x 9 mm



2 Medium Rectangular

Round, 2 Rings **MM2**



4 x 12 mm



3 Large Rectangular

Round, 3 Rings **MM3**



2.5 mm



Small Round

Round **MMRS**



4.5 mm



Large Round

Round **MMR**



Micro Mirrors

The following Micro Mirrors are compatible with these mirror handles:
10-130-70, 10-130-08, SHDPV, and SHTMBH.



Mirror Handles

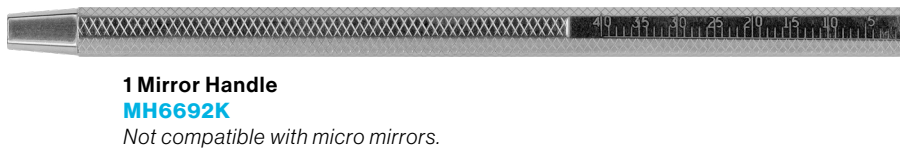
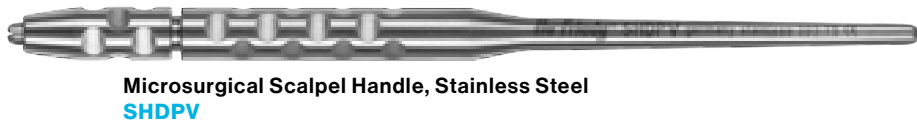

Currettes





1.5 mm
1 Abou-Rass Apical Surgical Curette SE
#40 **MAR-SC1**



2.5 mm
2 Abou-Rass Apical Surgical Curette SE
#40 **MAR-SC2**



3.0 mm
3 Abou-Rass Apical Surgical Curette SE
#40 **MAR-SC3**



4.0 mm
4 Abou-Rass Apical Surgical Curette SE
#40 **MAR-SC4**



1.0 mm
1 Al-Fouzan Curette
1.0 mm
#6 **MCAF1**

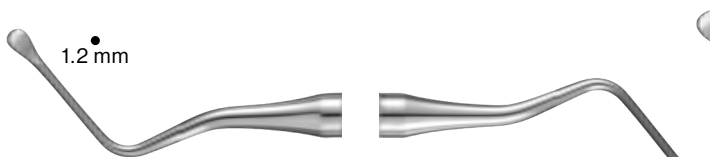

1.2 mm
2 Al-Fouzan Curette
1.2 mm
#6 **MCAF2**

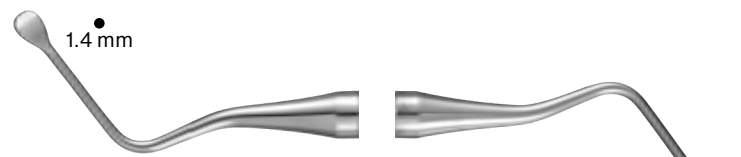

1.4 mm
3 Al-Fouzan Curette
1.4 mm
#6 **MCAF3**



0.5 mm
Berutti Pasqualini Curette
0.5 mm
Black Line **MBP-C1**

Refer to [page A903](#) for a detailed listing of [Prof. Elio Berutti](#) and [Prof. Damiano Pasqualini Microsurgical Endo Kit](#)

Explorers



1 Abou-Rass Endo Explorer DE
#33 **MAR-EX1**



2 Abou-Rass Endo Explorer SE
#41 **MAR-EX2**

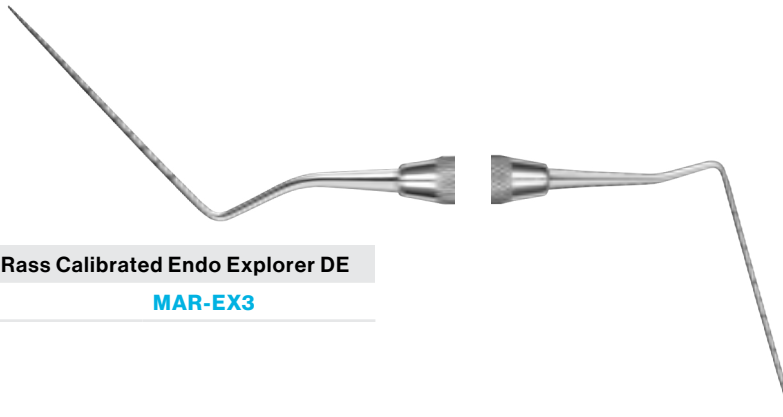

3 Abou-Rass Calibrated Endo Explorer DE
#1 **MAR-EX3**



4 Abou-Rass Endo Explorer SE
#40 **MAR-EX4**



5 Abou-Rass Endo Explorer SE
#40 **MAR-EX5**



6 Abou-Rass Endo Explorer SE
#40 **MAR-EX6**



1 Al-Fouzan Endo Explorer
#41 **EXAF1**



2 AI-Fouzan Endo Explorer

#41

EXAF2

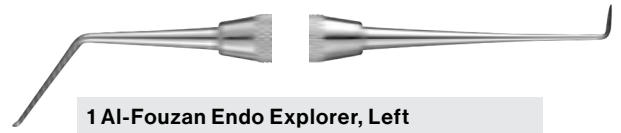

1 AI-Fouzan Endo Explorer, Left

#41

MEXAF1L

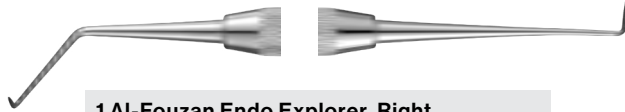

1 AI-Fouzan Endo Explorer, Right

#41

MEXAF1R

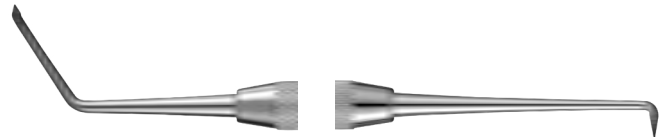

2 AI-Fouzan Endo Explorer, Left

#41

MEXAF2L



2 AI-Fouzan Endo Explorer, Right

#41

MEXAF2R



Berutti Pasqualini Explorer/Debrider

Black Line

MBP-EX1



Micro DE Explorer

#41

MEX1

Pluggers



Berutti Pasqualini Plugger

0.5 mm & 0.7 mm

Black Line

MBP-PLG1



Berutti Pasqualini Plugger
0.5 mm
Black Line **MBP-PLG2**



Berutti Pasqualini Plugger
0.7 mm
Black Line **MBP-PLG3**



1 Retro Filling DE Plugger
0.80 mm
#41 **PLGRF1**



2 Retro Filling DE Plugger
1.10 mm
#41 **PLGRF2**



Velvart Endo Plugger
0.25 mm / 0.33 mm
#41 **PLGVEL56**



Khayat Endo Plastic Filling Instrument
#6 Satin Steel **PF18ABK6**

• Refer to [page A902](#) for a detailed listing of
• [Dr. Bertrand Khayat Endodontic Surgical Kit](#)



Left Apical Micro-Retro Filling Instrument
#41 **MRFL**



Right Apical Micro-Retro Filling Instrument
#41 **MRFR**



Periosteal Elevators



1 Al-Fouzan Periosteal
0.80 mm
#6 **MPAF1**

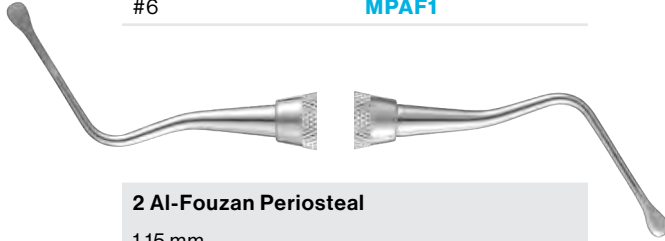

2 Al-Fouzan Periosteal
1.15 mm
#6 **MPAF2**

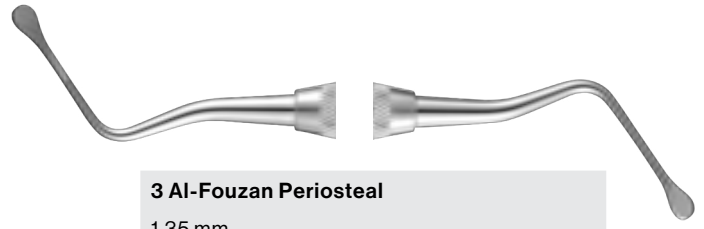

3 Al-Fouzan Periosteal
1.35 mm
#6 **MPAF3**



Berutti Pasqualini Elevator
1.4 mm
Black Line **MBP-E1**

Excavators



1 Abou-Rass Endo Excavator DE
1 mm
#41 **MAR-C1**



2 Abou-Rass Endo Excavator DE
2 mm
#41 **MAR-C2**

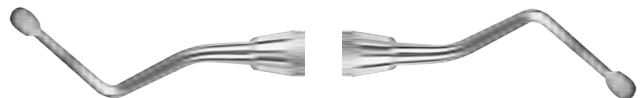

3 Abou-Rass Endo Excavator DE
3.2 mm
#41 **MAR-C3**

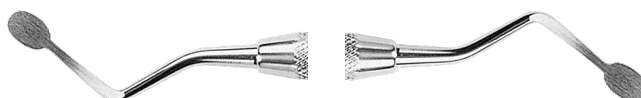

4 Abou-Rass Endo Excavator DE
4 mm
#41 **MAR-C4**

Condensers/Burnishers



.5 Abou-Rass Straight Apical Condenser
#41 **MAR-SAC.5**



1 Abou-Rass Straight Apical Condenser
#41 **MAR-SAC1**



1.5 Abou-Rass Straight Apical Condenser
#41 **MAR-SAC1.5**



2 Abou-Rass Straight Apical Condenser
#41 **MAR-SAC2**



3 Abou-Rass Straight Apical Condenser
#41 **MAR-SAC3**



.5 Abou-Rass Angulated Apical Condenser
#41 **MAR-AAC.5**



1 Abou-Rass Angulated Apical Condenser
#41 **MAR-AAC1**



1.5 Abou-Rass Angulated Apical Condenser
#41 **MAR-AAC1.5**



2 Abou-Rass Angulated Apical Condenser
#41 **MAR-AAC2**



3 Abou-Rass Angulated Apical Condenser
#41 **MAR-AAC3**



1 Abou-Rass Straight Burnisher
#40 **MAR-SB1**



2 Abou-Rass Straight Burnisher
#40 **MAR-SB2**



3 Abou-Rass Straight Burnisher
#40 **MAR-SB3**



4 Abou-Rass Straight Burnisher
#40 **MAR-SB4**



5 Abou-Rass Straight Burnisher
#40 **MAR-SB5**



1 Abou-Rass Angled Burnisher
#40 **MAR-B1**



2 Abou-Rass Angled Burnisher
#40 **MAR-B2**



3 Abou-Rass Angled Burnisher
#40 **MAR-B3**



4 Abou-Rass Angled Burnisher
#40 **MAR-B4**

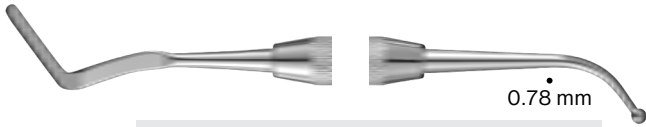

Al-Fouzan Burnisher, Left
#41 **MBPFIAFL**

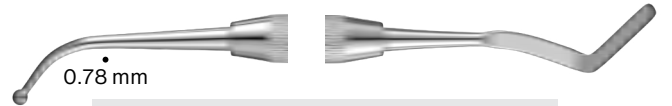

Al-Fouzan Burnisher, Right
#41 **MBPFIAFR**

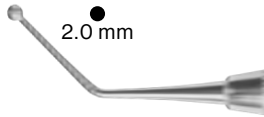

5 Abou-Rass Angled Burnisher
#40 **MAR-B5**

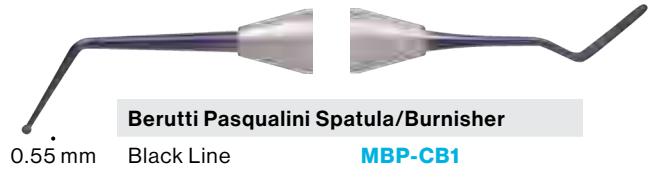

Berutti Pasqualini Spatula/Burnisher
Black Line **MBP-CB1**



Large Left Micro-Condenser/Burnisher
#41 **MCBLL**

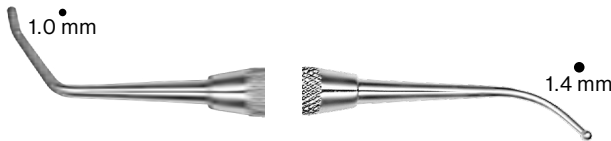

Large Right Micro-Condenser/Burnisher
#41 **MCBRL**

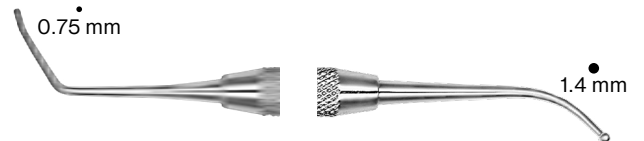

Medium Right Micro-Condenser/Burnisher
#41 **MCBRM**

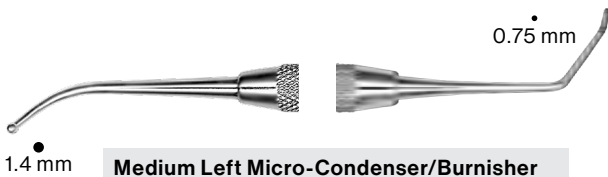

Medium Left Micro-Condenser/Burnisher
#41 **MCBLM**



Small Right Micro-Condenser/Burnisher
#41 **MCBRS**

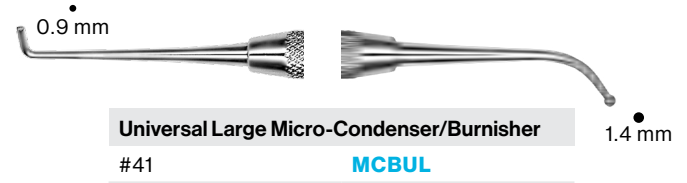
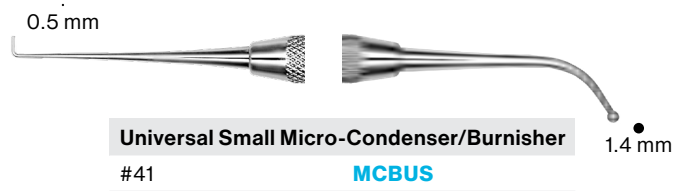
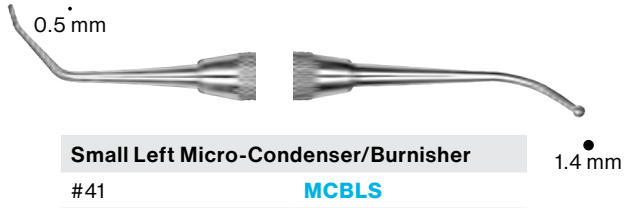

Explorers

Our endodontic explorers are made from a special blend of alloy which provides the flexibility, strength, tactile sensitivity and resilience clinicians need when exploring and assessing the treatment site. They are available in several double-ended designs and handles.



Learn more about our [Explorers](#).



DG16 DE Endo Explorer

Black Line	EXDG16X
#6	EXDG166
#7	EXDG167
#31	EXDG16
Thick	EXDG16T



DG16/17 DE Endo Explorer

Black Line	EXDG16/17X
#31	EXDG16/17

DG16/23 DE Endo Explorer

Black Line	EXDG16/23X
#31	EXDG16/23



Excavators

Our endodontic excavators feature extended-length shanks and are meticulously handcrafted from the highest grade stainless steel. They help the clinician access the pulp chamber for easy and efficient removal of dentin.



Learn more about our [Excavators](#).

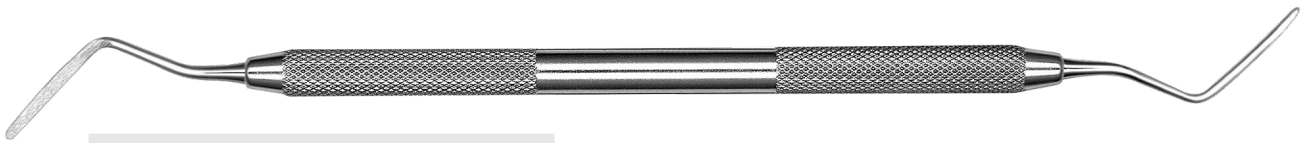

2 Glick DE Endo Excavator	
1.5 mm	
#41	EXCGL2

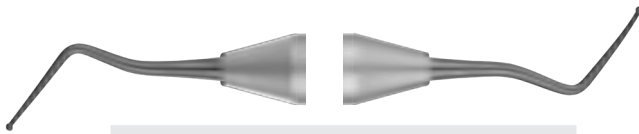

31L DE Endo Excavator	
1 mm	
Black Line	EXC31LX
#6	EXC31L6
#41	EXC31L

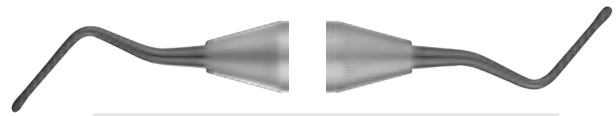

31W DE Oval Spoon Endo Excavator	
1.3 mm	
Black Line	EXC31WX
#6	EXC31W6
#41	EXC31W

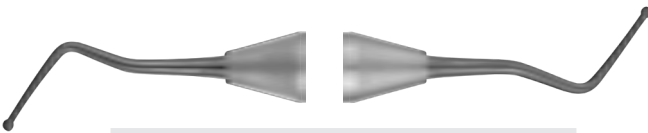

32L DE Endo Excavator	
1.5 mm	
Black Line	EXC32LX
#6	EXC32L6
#41	EXC32L

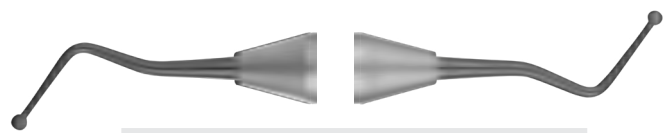

33L DE Endo Excavator	
2 mm	
Black Line	EXC33LX
#6	EXC33L6
#41	EXC33L

Spreaders

We manufacture a wide variety of spreaders, all handcrafted from the finest stainless steel to precise specifications. Our spreaders help the clinician gain access into the most difficult canals for optimal compaction of filling material during lateral condensation.



Learn more about our [Spreaders](#).



GP1 SE Root Canal Spreader	
.25 mm	
Black Line	RCSGP1X
#6	RCSGP16
#41	RCSGP1



1S Wakai SE Root Canal Spreader	
.30 mm	
#41	RCSW1S



2S Wakai SE Root Canal Spreader	
.40 mm	
#41	RCSW2S



D11S SE Root Canal Spreader, Thin	
.35 mm	
#41	RCSD11S



D11 SE Root Canal Spreader, Standard	
.40 mm	
Black Line	RCSD11X
#6	RCSD116
#41	RCSD11



D11T SE Root Canal Spreader, Thinner	
.23 mm	
Black Line	RCSD11TX
#6	RCSD11T6
#41	RCSD11T



D11TS SE Root Canal Spreader
Black Line **RCSD11TSX**
#41 **RCSD11TS**

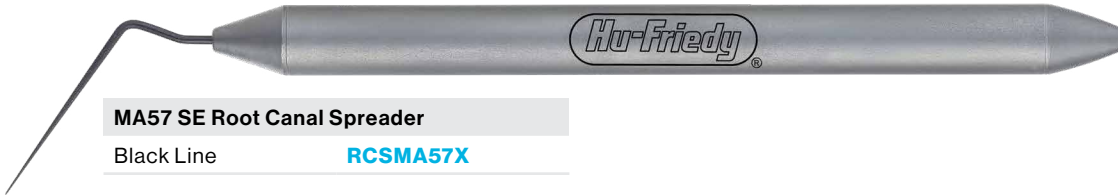

MA57 SE Root Canal Spreader
Black Line **RCSMA57X**



ISO Size 30 Endo Spreader
.30 mm
#41 **RCS30**



ISO Size 40 Endo Spreader
.40 mm
#41 **RCS40**



ISO Size 50 Endo Spreader
.50 mm
#41 **RCS50**



ISO Size 60 Endo Spreader
.60 mm
#41 **RCS60**

Nickel Titanium

Nickel Titanium, or NiTi, points provide these spreaders with extra flexibility and “memory” while the ergonomic, color coded Satin Steel™ Handles provide maximum comfort, control and easy identification. Choose from eight popular designs.



D11NT SE Root Canal Spreader
 .30 mm
 #7 **RCSD11NT**



D11TNT SE Root Canal Spreader
 .23 mm
 #7 **RCSD11TNT**

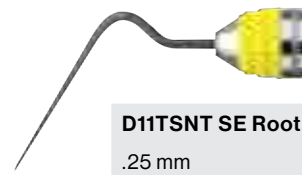

D11TSNT SE Root Canal Spreader
 .25 mm
 #7 **RCSD11TSNT**

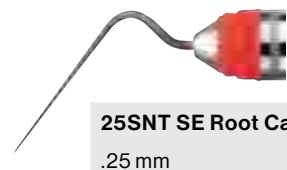

25SNT SE Root Canal Spreader
 .25 mm
 #7 **RCS25SNT**



25NT SE Root Canal Spreader
 .40 mm
 #7 **RCS25NT**



40SNT SE Root Canal Spreader
 .20 mm
 #7 **RCS40SNT**

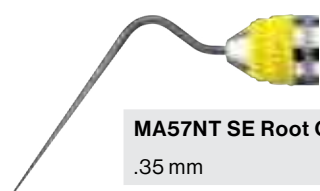

MA57NT SE Root Canal Spreader
 .35 mm
 #7 **RCSMA57NT**

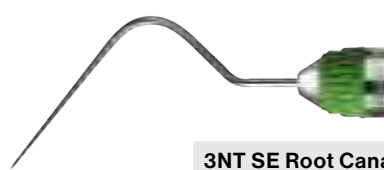

3NT SE Root Canal Spreader
 .35 mm
 #7 **RCS3NT**



3 SE Root Canal Spreader
.35 mm
#41 **RCS3**

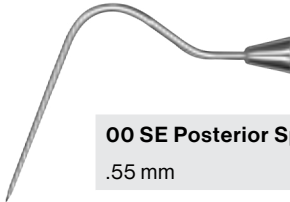

00 SE Posterior Spreader
.55 mm
#41 **RCS00P**

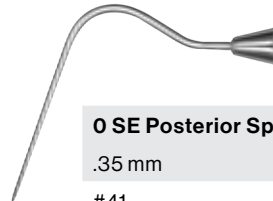

0 SE Posterior Spreader
.35 mm
#41 **RCS0P**

00 Anterior Root Canal Spreader
.55 mm
#41 **RCS00A**

0 Anterior Root Canal Spreader
.35 mm
#41 **RCS0A**



GP2 SE Root Canal Spreader
.35 mm
#41 **RCSGP2**

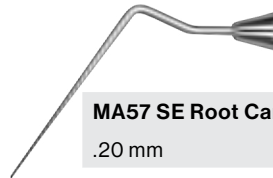

MA57 SE Root Canal Spreader
.20 mm
#41 **RCSMA57**

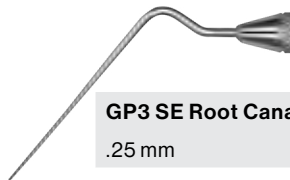

GP3 SE Root Canal Spreader
.25 mm
#41 **RCSGP3**

Pluggers

Our variety of pluggers give the clinician very different working ends for enhanced maneuvering and versatility.



Learn more about our [Pluggers](#).

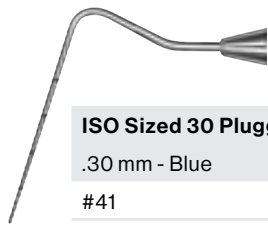

ISO Sized 30 Plugger
.30 mm - Blue
#41 **RCP30**

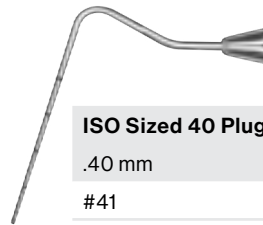

ISO Sized 40 Plugger
.40 mm
#41 **RCP40**



ISO Sized 50 Plugger
.50 mm - Yellow
#41 **RCP50**

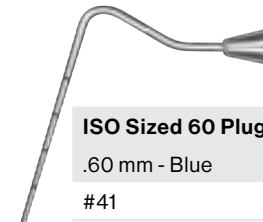

ISO Sized 60 Plugger
.60 mm - Blue
#41 **RCP60**

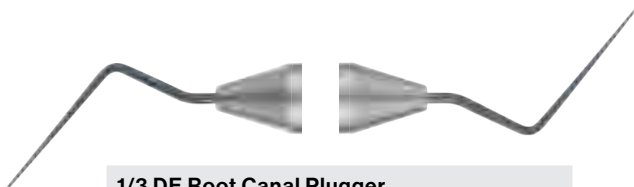

1/3 DE Root Canal Plugger
.40 mm / .45 mm
Black Line **RCP1/3X**
#41 **RCP1/3**

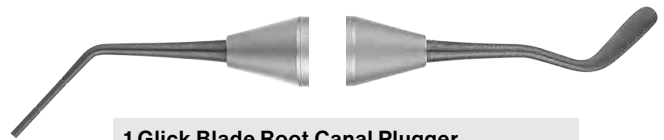

1 Glick Blade Root Canal Plugger
Black Line **RCPGL1X**
#41 **RCPGL1**

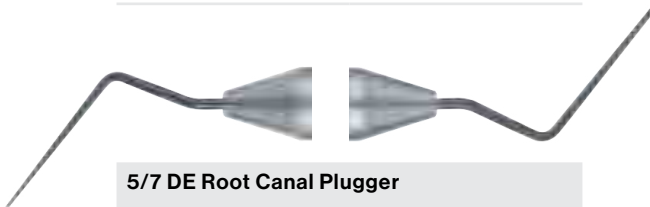

5/7 DE Root Canal Plugger
.50 mm / .75 mm
Black Line **RCP5/7X**
#41 **RCP5/7**

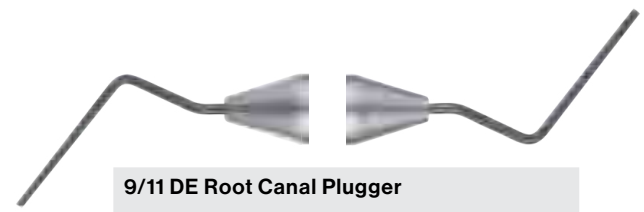

9/11 DE Root Canal Plugger
1.00 mm / 1.15 mm
Black Line **RCP9/11X**
#41 **RCP9/11**



Pluggers

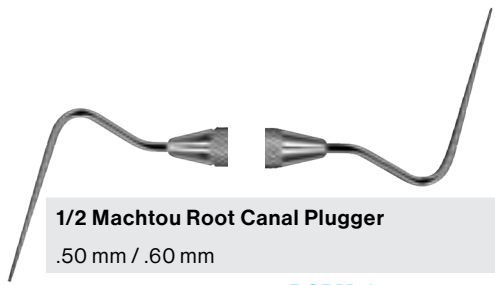

1/2 Machtou Root Canal Plugger

.50 mm / .60 mm

#41

RCPM1/2

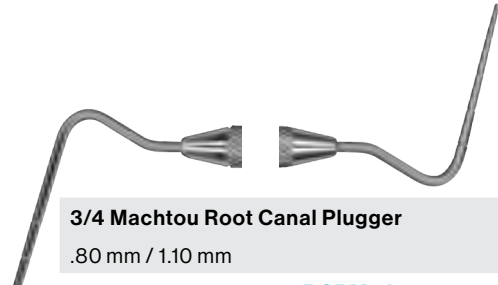

3/4 Machtou Root Canal Plugger

.80 mm / 1.10 mm

#41

RCPM3/4



1 DE Glick Plastic Plugger

#6

RCPGL16

#7

RCPGL17

#41

RCPGL1



1 SE Sleiman Root Canal Plugger

0.40 mm - 0.70 mm - White

#7

RCPSL172



2 SE Sleiman Root Canal Plugger

0.50 mm - 0.80 mm - Yellow

#7

RCPSL275



3 SE Sleiman Root Canal Plugger

0.66 mm - 0.96 mm - Red

#7

RCPSL376



4 SE Sleiman Root Canal Plugger

0.78 mm - 1.20 mm - Blue

#7

RCPSL478



5 SE Sleiman Root Canal Plugger

0.90 mm - 1.45 mm - Green

#7

RCPSL577



1 Luks SE Root Canal Plugger

0.45 mm

#41

RCPL1

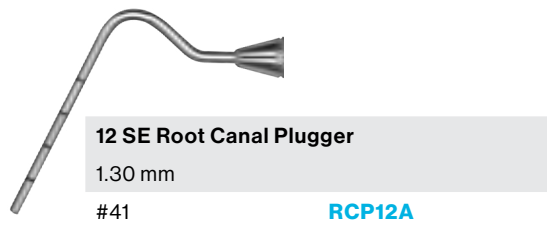
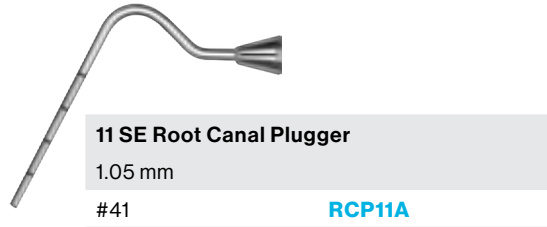
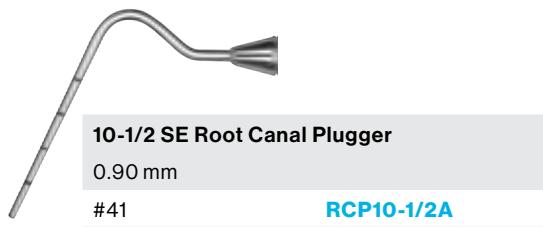
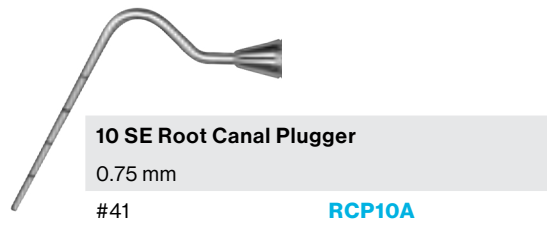
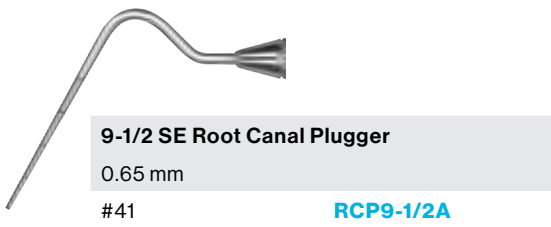
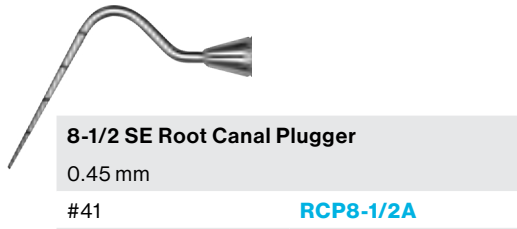
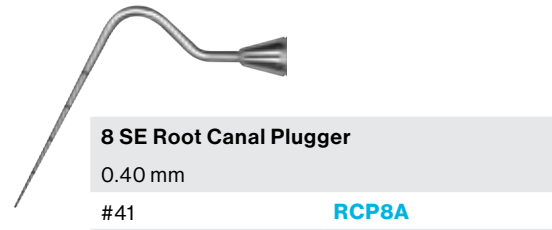
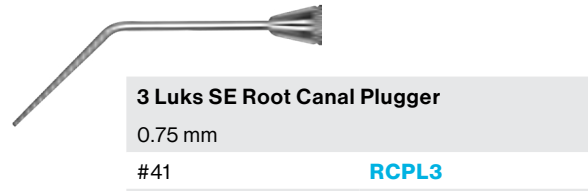
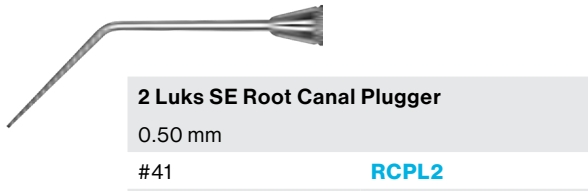



8 SE Root Canal Plugger
0.40 mm
#41 **RCP8**

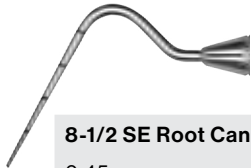

8-1/2 SE Root Canal Plugger
0.45 mm
#41 **RCP8-1/2**



9 SE Root Canal Plugger
0.55 mm
#41 **RCP9**

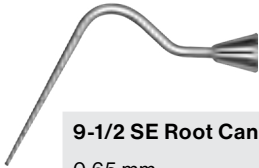

9-1/2 SE Root Canal Plugger
0.65 mm
#41 **RCP9-1/2**

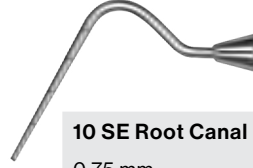

10 SE Root Canal Plugger
0.75 mm
#41 **RCP10**

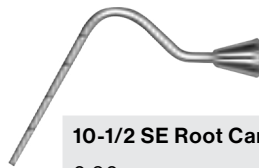

10-1/2 SE Root Canal Plugger
0.90 mm
#41 **RCP10-1/2**



11 SE Root Canal Plugger
1.05 mm
#41 **RCP11**



11-1/2 SE Root Canal Plugger
1.15 mm
#41 **RCP11-1/2**

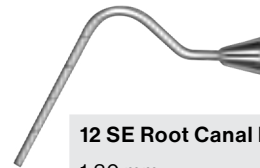

12 SE Root Canal Plugger
1.30 mm
#41 **RCP12**

**Post & Silver
Point Removal
Forceps**

Made from high quality stainless steel, our selection of Endodontic Forceps are designed for optimal balance, leverage, and control.



Learn more about our [Post & Silver Point Removal Forceps](#).

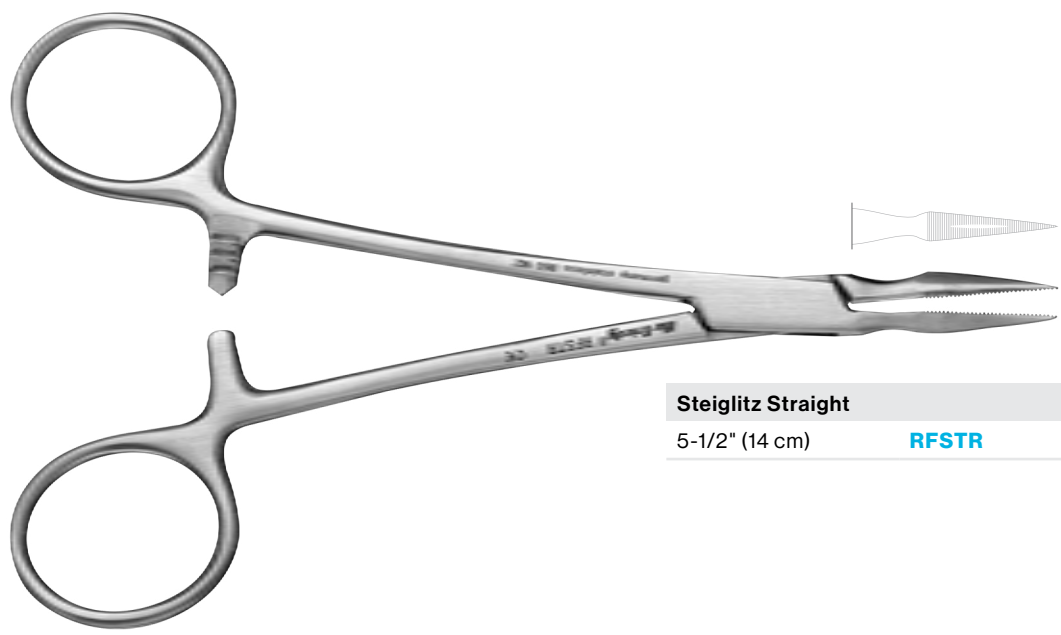

Steiglitz Straight
5-1/2" (14 cm) **RFSTR**

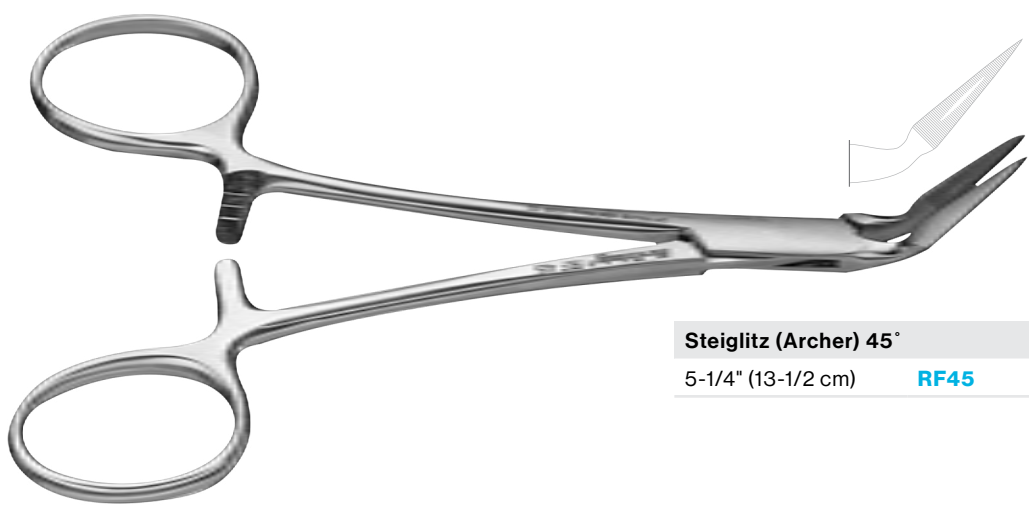

Steiglitz (Archer) 45°
5-1/4" (13-1/2 cm) **RF45**



Steiglitz 90°

4-3/4" (12 cm)

RF90



Peet 45°

4-3/4" (12 cm)

RFP

Rulers



6" Stainless Steel Ruler
6" (15.24 cm) **CLR6**

Locking Pliers

These Pliers include a locking feature for easier control of gutta percha points. Locking Pliers are made of high quality stainless steel and are handcrafted to precise specifications.



1 Endo Locking Pliers
6-1/2" (16-1/2 cm) **EPL1**

Collections & Kits	A1002
Clear Collection™ Instruments for Clear Aligners	A1004
Cutters	A1006
Utility Pliers	A1009
Wire Forming Pliers	A1012
Mathieus	A1015
Hand Instruments	A1016
Accessories	A1019

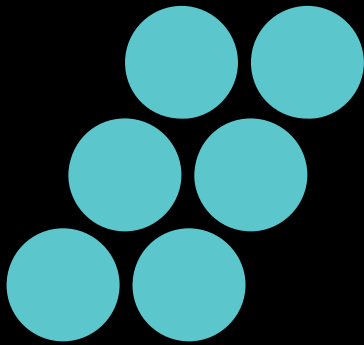

Orthodontic

As an orthodontist, your day is nonstop, facing a steady flow of patients, an overwhelming schedule, plus the desire to create beautiful, functional smiles for each and every patient. We are here to help. With consistent innovations like the Clear Collection™ Instruments for Clear Aligners, we put power and precision into your hands to help you be **The Best in Practice.**

Engineered to provide unrivaled clinical outcomes, our ergonomic designs ensure the comfort and confidence of both you and your patients. This results in a relaxed, calm environment that satisfies patients, parents and practitioners alike.



Collections & Kits

Being **The Best in Practice** means providing you with the solutions you need. With our array of Orthodontic Collections & Kits, everything an orthodontist needs for everyday procedures is all in one cassette. HuFriedyGroup curated kits with world renowned Key Opinion Leaders so you can carry out procedures with confidence knowing you have every instrument needed.

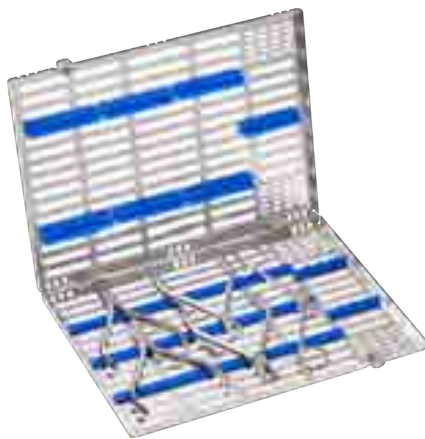

Clear Aligner Adjustment Kit	CLEARKIT
The Tear Drop	678-800
The Vertical	678-801
The Horizontal	678-802
The Hole Punch, 6mm	678-803
Curved Crown & Gold Scissors	SCGC
Large Thin Orthodontic Cassette	IMORHLG8

Alexander Kit	KIT-ALEX
H5/33 Sickle Scaler, #2 Handle	SH5/33
How Pliers	678-203
Micro Mini Pin & Ligature Cutter	678-107
Bird Beak Pliers	678-304
Mathieu Pliers	678-330
Hammerhead™ NiTi Pliers	678-327
Steiner Tying Pliers	678-222
Universal Cut & Hold Distal End Cutter, Long Handle	678-101L
Old Style Loop Pliers	678-324
Arch Bending Pliers	678-307
Large Thin Orthodontic Cassette	IMORHLG8



Learn more about our Key Opinion Leader **Dr. S. Jay Bowman.**



Learn more about our Key Opinion Leader **J. Moody Alexander.**

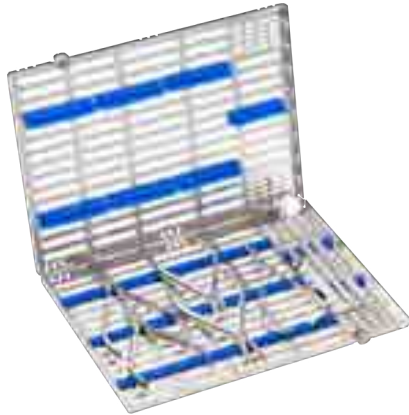

Ortho Adjustment Kit	ORTHOKIT1
Universal Cut & Hold Distal End Cutter, Long Handle	678-101L
Slim Micro Cutter	678-500
Slim Weingart Pliers	678-501
Bird Beak with Cutter	678-325
Mathieu Pliers	678-330
#6 Cone Socket Mirror Handle	MH6
#5 Front Surface Rhodium Single-Sided Cone Socket Mirror	MIR5
Slim Direct Bond Bracket Holder	678-504
Small Plugger-Picker	678-907
Large Thin Orthodontic Cassette	IMORTHLG8



Ortho Bonding Kit	ORTHOKIT2
Universal Cut & Hold Distal End Cutter, Long Handle	678-101L
Slim Micro Cutter	678-500
Band Seating Pliers	678-205
Mathieu Pliers	678-330
#6 Cone Socket Mirror Handle	MH6
#5 Front Surface Rhodium Single-Sided Cone Socket Mirror	MIR5
Slim Direct Bond Bracket Holder	678-504
Band Pusher/Dull Scaler	678-906
Small Thin Orthodontic Cassette	IMORTHSM8



Ortho Debanding/Debonding Kit	ORTHOKIT3
Universal Cut & Hold Distal End Cutter, Long Handle	678-101L
Slim Weingart Pliers	678-501
Slim Band Remover Pliers	678-503
Angulated Bracket Remover Pliers	678-220L
#6 Cone Socket Mirror Handle	MH6
#5 Front Surface Rhodium Single-Sided Cone Socket Mirror	MIR5
H6 Scaler/Picker	678-914
#23 Shepherd's Hook SE Explorer, #30 Handle	EXS23
Small Thin Orthodontic Cassette	IMORTHSM8



Ortho ArchWire Adjustment Standard Set-Up	IMORTHOAA
Large Ortho Double-Decker Cassette, Green	IM5209-OR
Cone Socket Mirror Handle, Satin Steel	MH6
#5 FS CS Mouth Mirror 3 pack	MIR5/3
Ligature Director/Scaler	678-905
Long Handle Universal Cutter w/hold	678-101L
Hard Wire Cutter 15 Degrees	678-103
Micro Mini Pin & Ligature Cutter	678-107
Long Handle Weingart Pliers	678-201L
Direct Bond Bracket Holder (tweezers)	678-212
Bird Beak Pliers	678-304
Three Jaw Pliers	678-302
Mathieu Pliers-Ortho	678-330



Clear Collection™ Instruments for Clear Aligners

The innovative Clear Collection™ Instruments for Clear Aligners are designed to accent, individualize and optimize the biomechanics of the “invisible” aligner experience with no heat required.



Learn more about our [Clear Collection™ instrument set.](#)



The Tear Drop
Creates droplet-shaped notches on gingival margins.
678-800

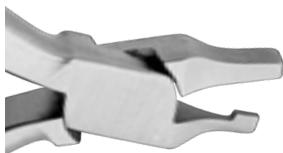

The Vertical
Creates rectangular indentions at the mesial or distal line angles on facial and/or lingual of a specific tooth to generate rotational couples.
678-801

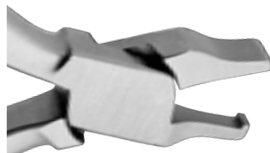

The Horizontal
Creates rectangular indentations at the gingival margin to accent individual root torque. Place below a bonded attachment to enhance retention.
678-802



The Hole Punch
Cuts 6 mm half-moon shape on the gingival margin where bonded buttons are to be placed.
678-803

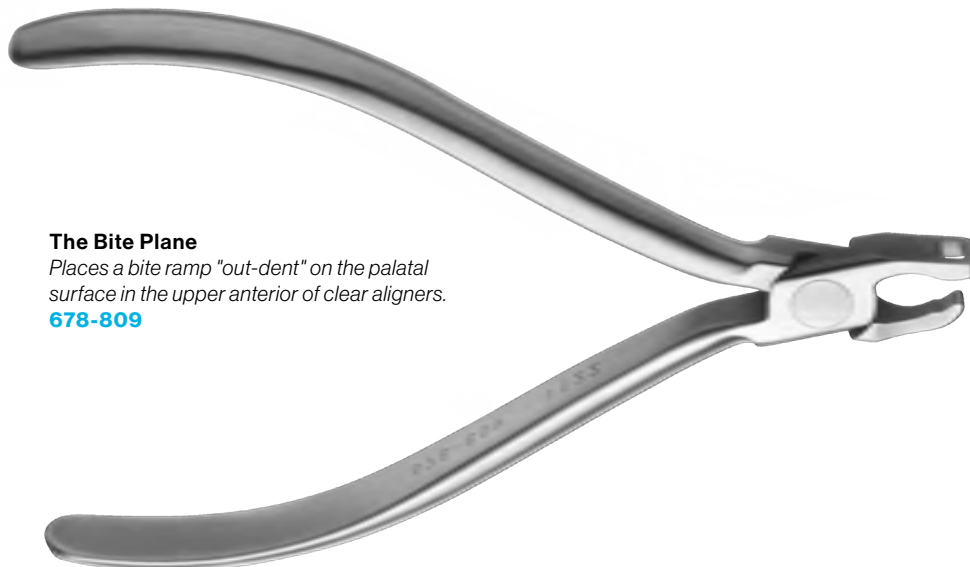

The Bite Plane
Places a bite ramp "out-dent" on the palatal surface in the upper anterior of clear aligners.
678-809



The Spot
Creates 1 mm dimple for spot contacts to accent small individual tooth movements or added aligner retention.
678-804



The Petite Punch
Cuts a 4.5 mm half-moon shape for use on the gingival margin where bonded buttons are to be placed.
678-805



The Counter Clockwise Wedge
Creates indentions at the line angle on the facial and the opposite line angle on the lingual for a specific tooth.
678-807



The Clockwise Wedge
Creates indentions at the line angle on the facial and the opposite line angle on the lingual for a specific tooth.
678-808



The Bootstrap Punch
Cuts precise elongated cutout to accommodate bonded buttons on the labial and lingual sides of mandible and maxillary gumlines.
678-810



The Eraser
Eliminates unwanted or no-longer-needed indentions anywhere on clear aligners.
678-811



The Precision Aligner Punch™
Creates cutouts for incorporating Precision Aligner Buttons® and elastics on the upper and lower molars.
678-812



The Multi Punch
Creates precise ellipsoid cutouts on the difficult-to-reach occlusal aspect of clear aligners.
678-813



Cutters

With our diamond-honed cutting edges and orbit-formed joint, you will experience sharp and accurately-aligned cutting edges for every procedure, every time. For each individual area of focus, we provide a specifically engineered cutter. To meet these stringent standards, all of our blades are hand-finished to maximize cutting performance for the appropriate wire size.



Learn how to extend the longevity of your cutter with [regular sharpening through HuCare](#).

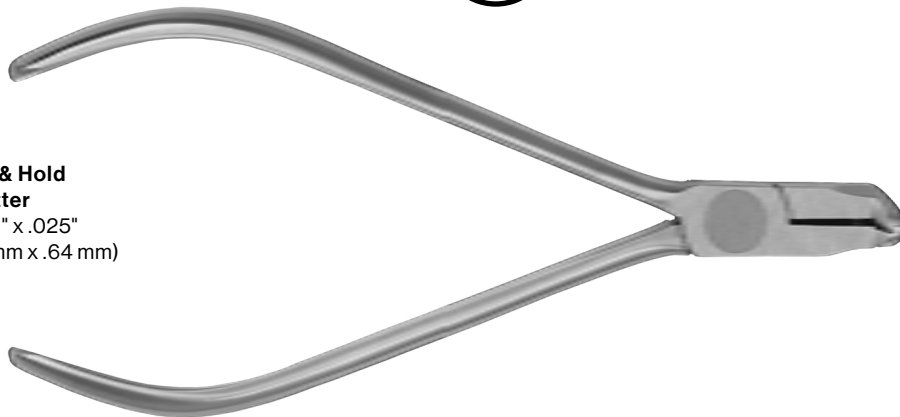

Universal Cut & Hold Distal End Cutter
< = .012" to .021" x .025"
(.30 mm – .53 mm x .64 mm)
678-101



Universal Cut & Hold Distal End Cutter, Long Handle
< = .012" to .021" x .025"
(.30 mm – .53 mm x .64 mm)
678-101L



Flush Cut Distal End Cutter, No Hold
< = .021" x .025"
(.53 mm x .64 mm)
678-102

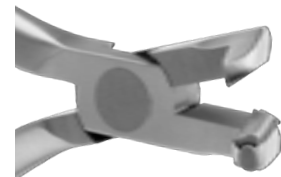

Flush Cut & Hold Distal End Cutter
< = .020"
(.51 mm)
678-111

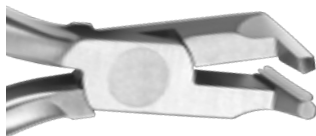

Slim Flush Cut & Hold Distal End Cutter
< = .012" to .021" x .025"
(.30 mm – .53 mm x .64 mm)
678-113



Lingual Distal End Cutter
.012" to .018"
(.30mm to .46mm)
678-700



Hard Wire Cutter, 15°
< = .022" x .028"
(.56 mm x .71 mm)
678-103



Hard Wire Cutter
 <= .022" x .028"
678-104



Multi-Use Cutter
 <= .015" (.38 mm)
678-105

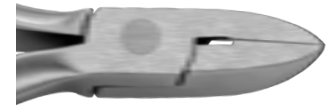

Mini Pin & Ligature Cutter
 <= .012" (.30 mm)
678-106



Micro Mini Pin & Ligature Cutter
 <= .012" (.30 mm)
678-107



Micro Mini Pin & Ligature Cutter, Long Handle
 <= .012" (.30 mm)
678-107L

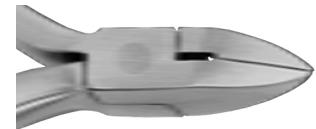

Micro Mini Ligature Cutter, 15°
 <= .012" (.30 mm)
678-109



Micro Cutter
 <= .012" (.30 mm)
678-110



Lingual Pin & Ligature Cutter
 <= .012" (.30 mm)
678-701



Slim Micro Cutter
 <= .008" to .012"
 (.20mm to .30mm)
678-500

HuCare

Orthodontic Instrument Care Program



Through our **Warranty Program for Orthodontic Instruments**, **HuFriedyGroup** is pleased to offer **free servicing for the life of the instrument.***

When you purchase the highest quality products, it is important to keep them in optimal working condition.

Sign up to:

- Protect your investments through regular, free service
- Free up valuable time to focus on providing positive clinical outcomes for your patients
- Ensure accurate servicing by the same HuFriedyGroup artisans that manufactured your instruments



Visit [HuFriedyGroup.com/HuCare-Ortho/SignUp](https://www.hufriedygroup.com/HuCare-Ortho/SignUp)

*Covered for the life expectancy of product, not life of doctor or practice.

Utility Pliers

Strong, yet lightweight and perfectly balanced, the dimensions of these instruments are perfectly proportioned, they fit your grasp with unsurpassed ease. Designed to provide superior control with effortless versatility, Our Utility Pliers assure comfort to both you and your patients.



[View more Utility Pliers.](#)

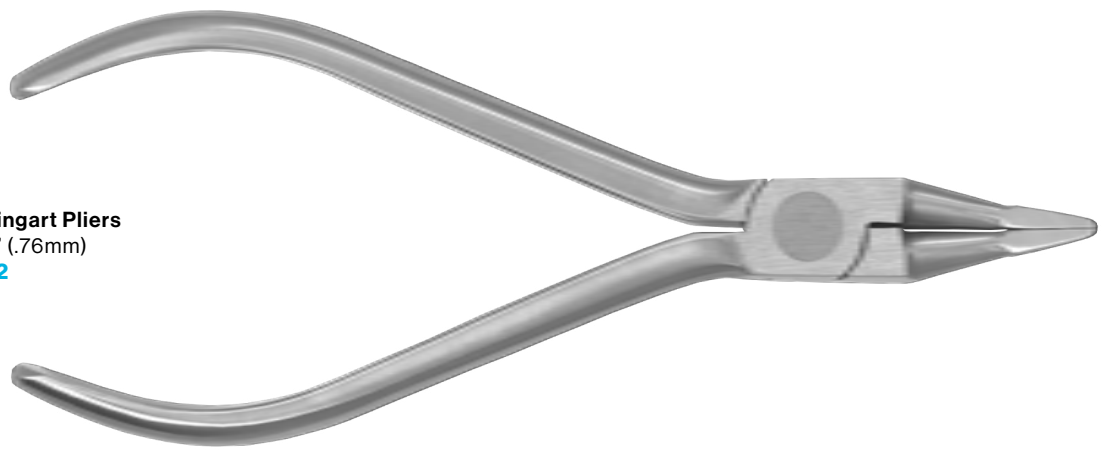

Slim Weingart Pliers
< = .030" (.76mm)
678-202



Ultra Slim Weingart Pliers
< = .030" (.76mm)
678-200

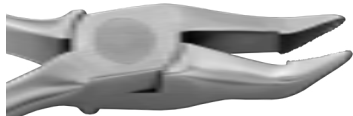

Weingart Pliers
< = .030" (.76mm)
678-201

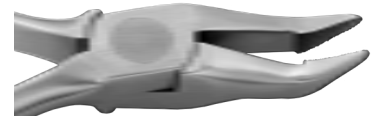

Weingart Pliers, Long Handle
< = .030" (.76mm)
678-201L



Slim Weingart Pliers
< = .030" (.76mm)
678-501



Lingual Weingart Pliers
< = .030" (.76mm)
678-702



Lingual Weingart Pliers, 90°
< = .030" (.76mm)
678-702-90

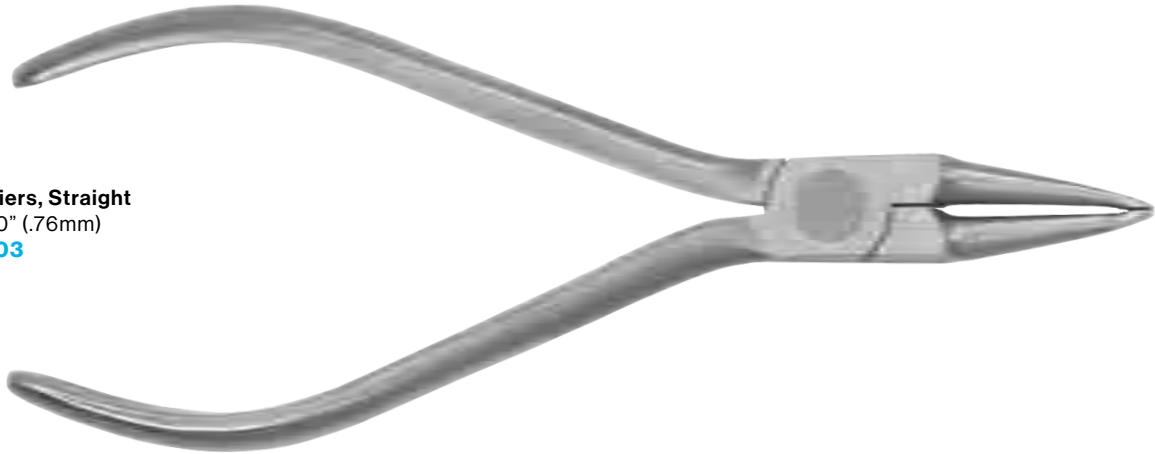

How Pliers, Straight
< = .030" (.76mm)
678-203



How Pliers, Offset
< = .030" (.76mm)
678-204



Band Seating Pliers
678-205



Adhesive Removing Pliers
678-206

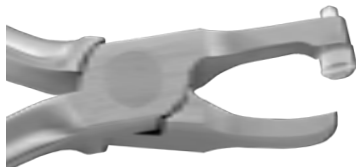

Band Removing Pliers, Long Beak
678-207

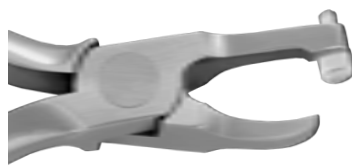

Band Removing Pliers, Short Beak
678-208



Slim Band Remover Pliers, Long Beak
678-503



Force Module Separating Pliers
678-210



Coon Style Ligature Tying Pliers
< = .015" (.38mm)
678-211



Steiner Tying Pliers
< = .015" (.38mm)
678-222

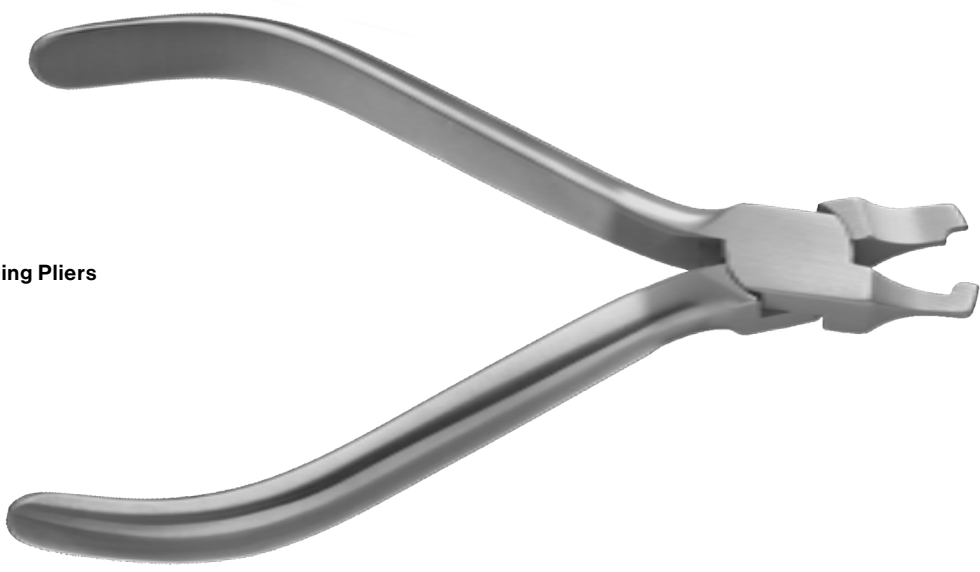

Band Crimping Pliers
678-225

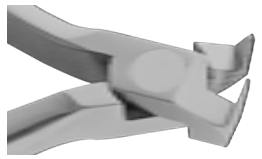

Tip Back Pliers
< = .022" x .025" (.56 mm x .64 mm)
678-216

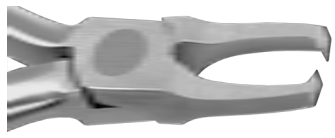

Bracket Removing Pliers
678-219

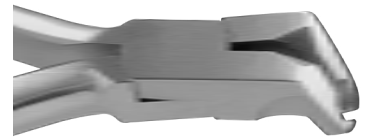

Angulated Bracket Remover Pliers
678-220L



Crown & Band Contouring Pliers
678-221



Slim Crown & Band Contouring Pliers
678-221M

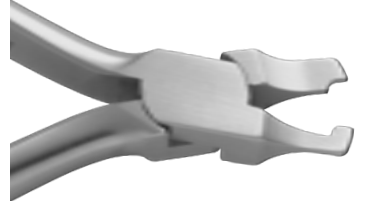

Band Crimping Pliers with Spring
678-225M



Lingual Bracket Removing Pliers
678-703

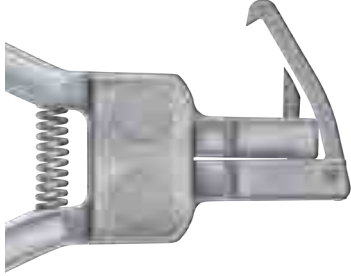

Lingual Debonding Pliers
678-709



Wire Forming Pliers

These instruments perform as natural extensions of your professional artistry. Our impeccably smooth finished tips allow you to bend the wire without risk of damage. Whether you are shaping stainless steel or nickel titanium, these hand-finished, precision instrument help you bring your brilliant workmanship to life.



View more [Orthodontic Wire Forming Pliers](#).

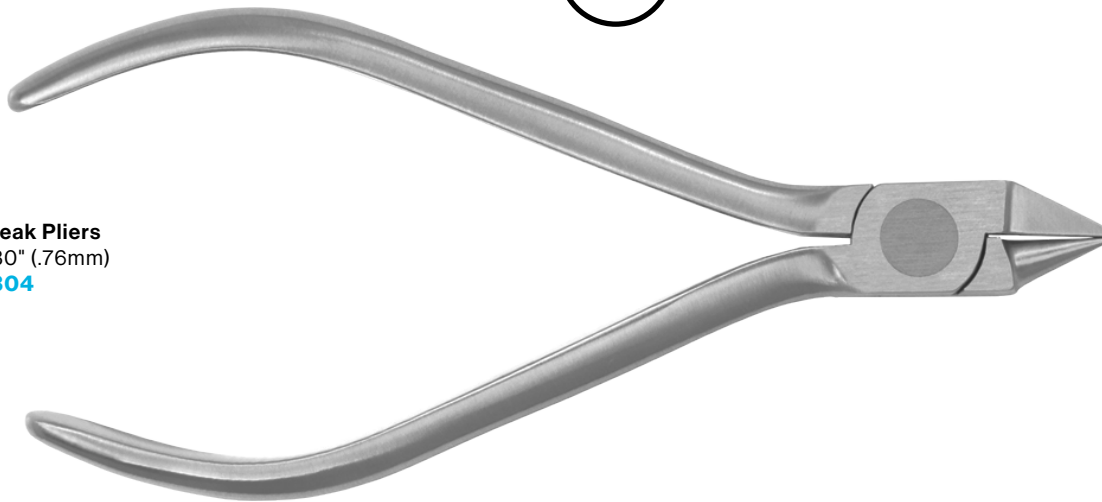

Bird Beak Pliers
< = .030" (.76mm)
678-304

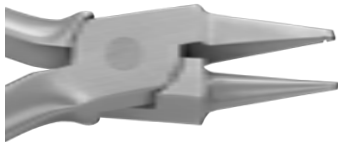

Light Wire Bird Beak Pliers w/ Groove
< = .020" (.51mm)
678-305



Light Wire Bird Beak Pliers
< = .020" (.51mm)
678-318



Bird Beak with Cutter
< = .022" x .028" (.56mm x .71mm)
678-325



Long Tapered Bird Beak Pliers
< = .022" x .028" (.56mm x .71mm)
678-326

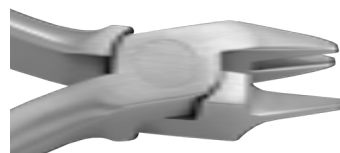

Three Jaw Pliers
< = .030" (.76mm)
678-302

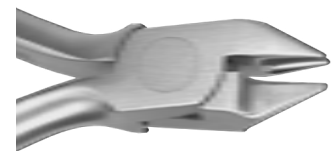

Mini Three Jaw Pliers
< = .030" (.76mm)
678-312



Jarabak Pliers
 <= .020" (.51mm)
678-301

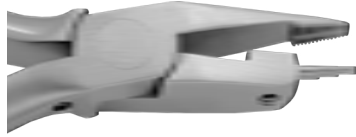

Omega Loop Forming Pliers
 <= .022" x .025" (.56 mm x .64mm)
678-303

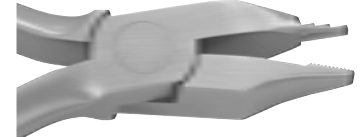

Tweed Loop Forming Pliers
 <= .022" x .028" (.56mm x .71mm)
678-306

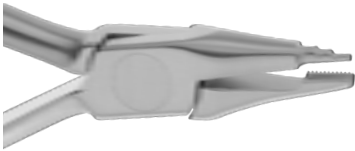

O'Brien Pliers
 <= .020" (.51mm)
678-311

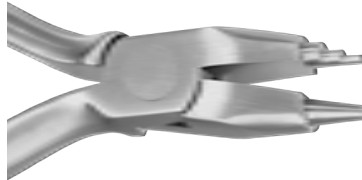

Marcotte Looping Pliers
 <= .022" x .028" (.56mm x .71mm)
678-316



Nance Loop Forming Pliers
 <= .022" (.53mm)
678-319

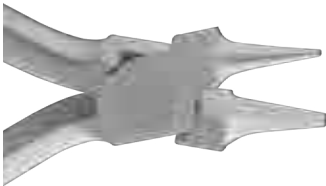

Optical Pliers
 <= .022" x .028" (.56mm x .71mm)
678-323



Old Style Loop Pliers
 <= .022" x .028" (.56mm x .71mm)
678-324

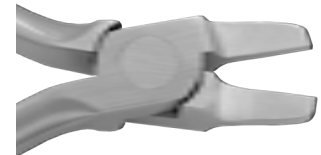

Arch Bending Pliers, .050"
 <= .022" x .028" (.56mm x .71mm)
678-307



Slim Arch Bending Pliers, .025"
 <= .022" x .028" (.56mm x .71mm)
678-307S

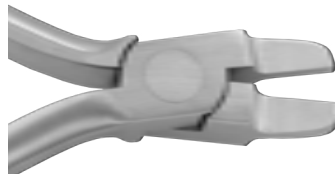

Rectangular Arch Bending Pliers, .070"
 <= .022" x .028" (.56mm x .71mm)
678-308



Lingual Arch Forming Pliers
 <= .036" (.91 mm)
678-309



V-Stop Pliers
 <= .022" x .028" (.56mm x .71mm)
678-321



Hollow Chop Contouring Pliers, 0.4" Dia.
 <= .030" (.76mm)
678-310



General Contouring Pliers
 <= .021" x .025" (.53mm x .64mm)
678-315

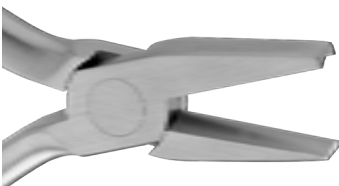

Hollow Chop Contouring Pliers, 0.5" Dia.
 <= .030" (.76mm)
678-317



Adams Pliers
 <= .040" (1.01mm)
678-320

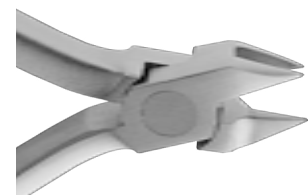

NiTi Three Jaw Pliers
 <= .020" (.51mm)
678-322



Hammerhead™ NiTi Pliers
< = .025" (.64mm)
678-327



Slim Hammerhead™ NiTi Pliers
< = .025" (.64mm)
678-502



Lingual Hammerhead™ NiTi Pliers
< = .025" (.64mm)
678-704



Lingual Hammerhead™ NiTi Pliers with Serrations
< = .025" (.64mm)
678-704SER



Torquing Pliers with Key .016"/.018"
.016"/.018" (.41mm/.46mm)
678-328-20



Torquing Pliers with Key .019"/.022"
.019"/.022" (.46mm/.56mm)
678-328-21

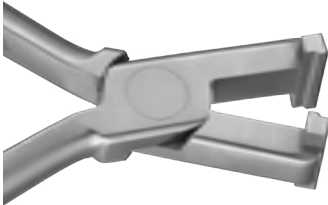

Step Pliers, 1/2MM
.020" (1/2mm)
678-340

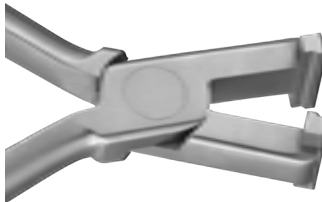

Step Pliers, 3/4 MM
.030" (3/4mm)
678-341

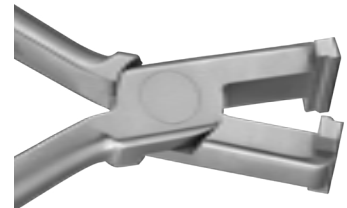

Step Pliers, 1MM
.039" (1mm)
678-342



Hammerhead™ NiTi Pliers
< = .025" (.64mm)
678-327



Created with the same meticulous attention to detail as our pliers, our mathieus are also forged from Immunity Steel™ Alloy, making them resistant to rust and corrosion.



Learn more about our [Mathieus](#).

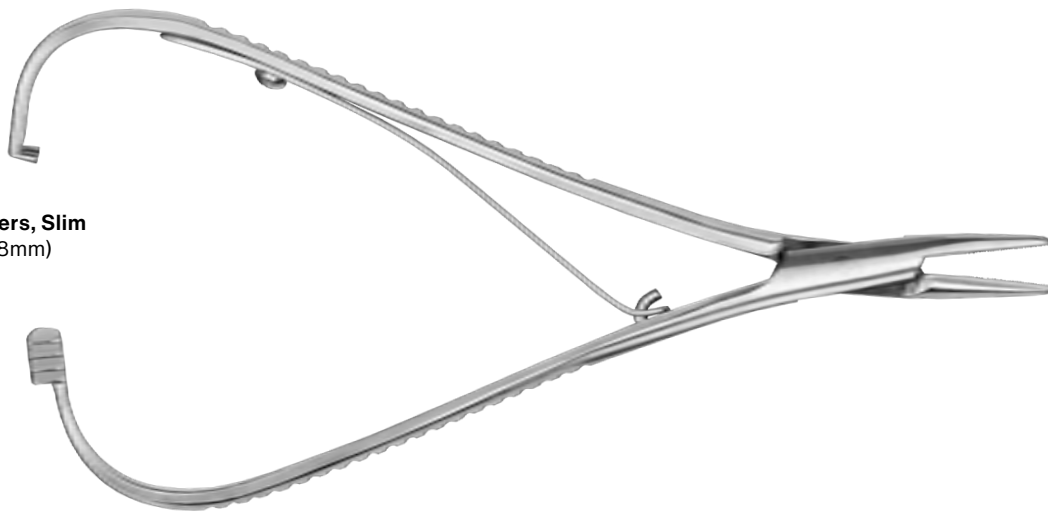

Mathieu Pliers, Slim
 <= .015" (.38mm)
678-330



Mathieu Pliers
 <= .015" (.38mm)
678-331



Mathieu Pliers, Perma Sharp™
 <= .015" (.38mm)
678-332



Mathieu Pliers, Lingual
 <= .015" (.38mm)
678-705



Hand Instruments

All of our Orthodontic hand instruments are available in a variety of ergonomic handle sizes to accommodate your personal preference. Finely tuned to achieve accurate weight, balance and tip alignment, we produce only the highest caliber tips and handles, in the manner of precision and excellence you demand.



View more [Hand Instruments](#).

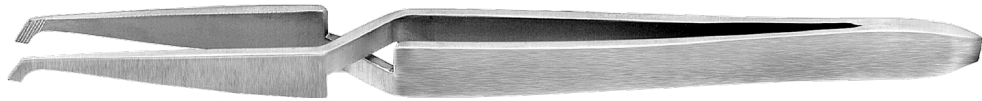

Direct Bond Bracket Holder
678-212

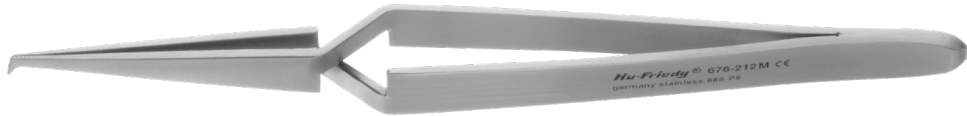

Ultra Slim Direct Bond Bracket Holder
678-212M



Slim Direct Bond Bracket Holder
678-504



Slim Buccal Tube Holder
678-505



Lingual Torquing Key with Picker
678-708



Distal Cinch Back
 < = .021" x .025" (.53 mm x .64 mm)
678-506



Lingual Ligature Director
 < = .021" x .025" (.53 mm x .64 mm)
678-706

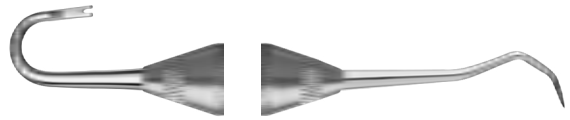

Lingual Ligature Director, U Shaped
 < = .021" x .025" (.53 mm x .64 mm)
678-707



Scaler/Band Pusher
678-904

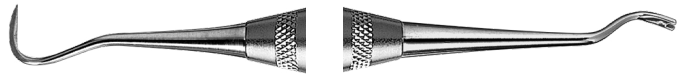

Ligature Director/Scaler
678-905



Band Pusher/Dull Scaler
678-906



Small Plugger/Picker
678-907



Ligature Director/Band Pusher
678-908



Large Plugger/Picker
678-909

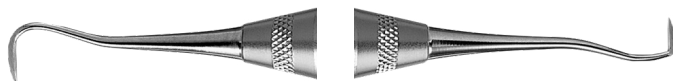

Dull Scaler
678-910



Dull Scaler
678-911



Scaler/Picker
678-914



Picker/Ligature Director
678-916



Ligature Director/Band Pusher
678-912



Dull Scaler
678-913



Band Pusher
BP300

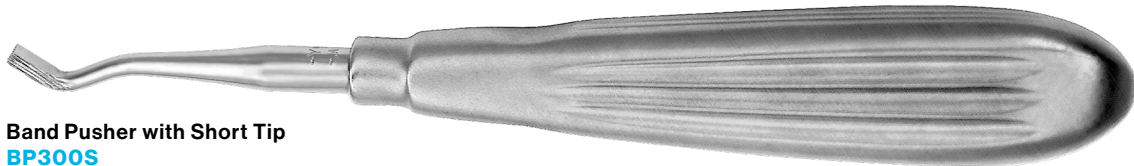

Band Pusher with Short Tip
BP300S



Band Pusher/Scaler
BPS1



Band Pusher/Scaler
BPS2

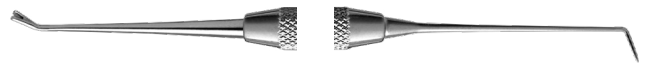

Fillion Explorer/Ligature Director
FE/LD



Ligature Director/Plugger
LDP



Plugger/Ligature Picker
PLPK



Ligature Director
LDG2



Ligature Director
LD1



Ligature Director/Tucker
LDT



Lingual Ligature Director, .018"
.018" (.46mm)
SNLD1



Lingual Ligature Director, .025"
.025" (.64mm)
SNLD2



Lingual Torquing Key
 .018" (.46mm)
TK018



Lingual Torquing Key, Straight
 .020" (.51mm)
TK020S



Twirl-On Ligature Applicator
TWLA



Ligature Director
WBI-M/R

Accessories

Replacement Blade for 678-206

QTY: 1 **678-001**

Replacement Blade for 678-303

QTY: 1 **678-002**

Silicone Insert for 678-111

QTY: 3 **678-011**

Silicone Insert for 678-113

QTY: 3 **678-013**

1/4" Replacement Pads for 678-207, 678-208, 678-503

QTY: 6 **678-014**

1/4" Replacement pads for 678-206

QTY: 6 **678-014A**

1/8" Replacement Set Screw and Hex Key for 678-303

QTY: 1 **678-018**

Torquing Key .016" / .018"

QTY: 1 **678-020**

Torquing Key .019" / .022"

QTY: 1 **678-021**

3/16" Replacement Pads for 678-207, 678-208, 678-503

QTY: 6 **678-036**

O-Ring Refills for 678-114

QTY: 50 **678-114R50**

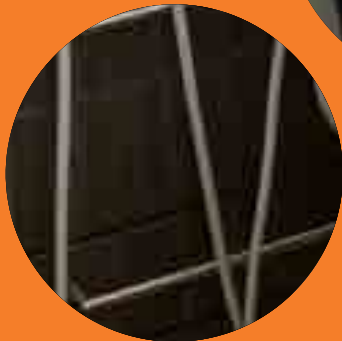
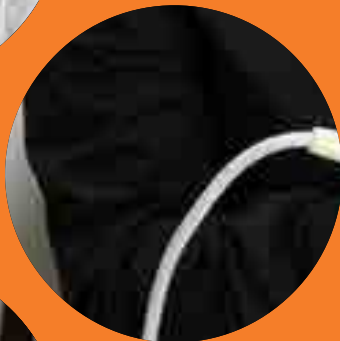

Note: some of the devices, products, and/or programs advertised may not be licensed for sale outside the United States. Contact your local sales or customer care representative for availability details. For full product warranty details, please visit [HuFriedyGroup.com/services/warranties](https://www.hufriedygroup.com/services/warranties)

The contents of this catalog including, but not limited to, all text, photographs and graphics, are the sole and exclusive property of Hu-Friedy Mfg. Co., LLC its affiliates or related companies and may not be copied, reproduced or distributed without prior written permission.

Hu-Friedy Mfg. Co., LLC, 1666 E. Touhy Ave., Des Plaines, IL 60018 | [HuFriedyGroup.com](https://www.hufriedygroup.com)

All company and product names are trademarks of Hu-Friedy Mfg. Co., LLC its affiliates or related companies, unless otherwise noted. SATELEC® is a registered trademark of Acteon, Inc. NSK® is a registered trademark of Nakanishi, Inc. EMS® is a trademark of EMS Electro Medical Systems GmbH.



Power

Our selection of power scaling technology is designed to ensure the comfort of dental patients and professionals. With Air Polishing, Magneto and Piezo Scaling options, you can experience dental instrumentation that will satisfy your clinical objectives and your personal preferences.

Air Polishing

B101

Piezo

B201

Magneto

B301

PWR Pair

PWR Pair Piezo Scaling & Air Polishing Device

PWR Air Polishing Accessories

B102

B102

B103

PWR Prophylaxis Powder

PWR Perio Prophylaxis Powder

PWR Classic Prophylaxis Powder

B104

B104

B105

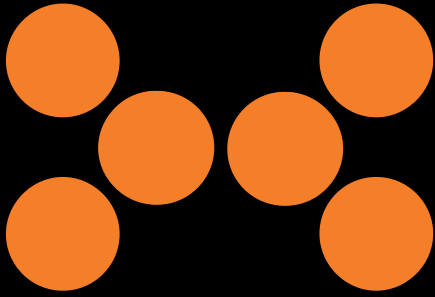

Air Polishing

Our PWR air polishing products utilize PWR Prophylaxis Powder combined with air and water to supra- and subgingivally remove biofilm and the tough stains caused by everyday foods and beverages. Air polishing also helps remove interproximal biofilm and food debris.



PWR Pair

The power of all-in-one brings versatile air polishing to every clinician treating every patient. The PWR Pair brings you the power of sub- and supragingival calculus and stain removal, biofilm disruption, and implant cleaning.



Learn more about all our [PWR Piezo Scaling & Air Polishing](#)

PWR Pair Piezo Scaling & Air Polishing Device

The PWR Pair utilizes PWR Prophylaxis Powder combined with air and water to sub- and supragingivally remove biofilm, and the tough stains caused by everyday foods and beverages. The PWR Pair also puts the PWR in power scaling. The Pair's Piezo technology allows for a comfortable experience for patients and clinicians. The advanced feedback system gives the clinician perfect control over performance to improve results and increase comfort.

Air Polishing



NEW! PWR Pair Piezo Scaling & Air Polishing Device
APPAIR

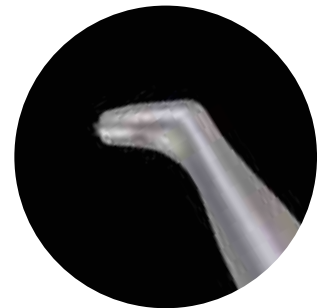

APHP120

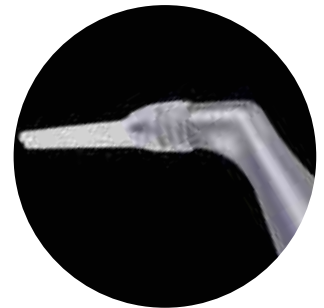

APHPPERIO



Your Patient, Your Power. Learn more about the PWR Pair Piezo Scaling & Air Polishing Device by [downloading the brochure](#) today.

PWR Air Polishing Accessories

PWR Air Polishing Accessories included with PWR Pair



PWR Air 120° Handpiece
APHP120



PWR Air Perio Handpiece
APHPPERIO

• **Did You Know?**
 • All PWR Pair Air Polishing handpieces are made from steel and resilient to cracking. Practice with the PWR of peace of mind: fewer interruptions and replacements.



PWR Air Perio Subgingival Tips
 Box of 40 **APPERIOTIPS**

PWR Air Powder Chamber Propy	WAPPCPROPHY
PWR Air Powder Chamber Perio	APPCPERIO
PWR Air Powder Chamber Cap	APPCCAP
PWR Air K9 Wrench Tip	APK9
PWR Air Unit Water Supply Hose	APH20HOSE
PWR Air Unit Supply Hose	APAIRHOSE
PWR Air O-Ring Set	APORINGS
PWR Air Irrigation Circuit Disinfection	APICDKIT
PWR Air Unit Water Filter	APFILTER
PWR Air Cleaning Needle Kit	APNDLKIT

Additional PWR Air Polishing Accessories



PWR Air 90° Handpiece
APHP90

• **Want to know more about PWR Piezo Scaling?**
 • Find PWR Piezo products included with PWR Pair
 • Device on [Page B203](#)





PWR Prophylaxis Powder

PWR Prophylaxis Powders remove supra- and subgingival biofilm, stains and pigmentations along with treating peri-implantitis and cleaning of prosthesis and restorative materials.



Learn more about all our [PWR Piezo Scaling & Air Polishing](#)

Air Polishing

PWR Perio Prophylaxis Powder

The glycine-based PWR Perio Powder helps remove supra- and subgingival biofilm, periodontal pocket detoxification, implant maintenance, peri-implantitis treatment, fixed orthodontic appliances, and cleaning of prosthesis and restorative materials. PWR Perio Powder comes in a box of two 5.64 oz bottles. PWR Perio Powder is available in mint and neutral flavors with hydrophobic effect, which helps lessen clogging in the PWR Pair.



PWR Perio Prophylaxis Powder	
Mint Flavor, Box of 2 Bottles (5.64 oz each)	AP-PM
Neutral Flavor, Box of 2 Bottles (5.64 oz each)	AP-PN



See the PWR Pair utilize PWR Prophylaxis Powders in action by [requesting an in-office demo](#) today.

PWR Classic Prophylaxis Powder

The sodium bicarbonate based PWR Classic Powder helps remove supragingival biofilm, stains, and pigmentations. PWR Classic Powder comes in a box of four 8.82 oz bottles. PWR Classic Powder is available in mint and neutral flavors with hydrophobic effect, which helps decrease clogging in the PWR Pair.



PWR Classic Prophylaxis Powder	
Mint Flavor, Box of 4 Bottles (8.82 oz each)	AP-CM
Neutral Flavor, Box of 4 Bottles (8.82 oz each)	AP-CN

• Tips for PWRful Procedures

PWR Prophylaxis Powders have you covered no matter the situation.

	Classic	Perio
Supragingival Biofilm Removal	●	●
Removal of Stains & Pigmentations on Enamel	●	
Subgingival Biofilm Removal		●
Periodontal Pocket Detoxification		●
Implant Maintenance		●
Peri-Implantitis Treatment		●
Fixed Orthodontic Appliances		●
Cleaning of Prosthesis & Restoration Materials		●
Restorations Maintenance		●

PWR Piezo	B202
PWR Piezo Piezoelectric Scaling Device	B202
PWR Pair Piezo Scaling & Air Polishing Device	B203
PWR Piezo Tips	B204
PWR Scaling Piezo Tips	B204
PWR Perio Piezo Tips	B205
PWR Implant Cleaning Piezo Tips	B205
PWR Endodontic Piezo Tips	B206
PWR Piezo Tip Sets	B207
Piezo Tips	B208
Piezo Reference Guide	B210
Characteristics of Tip Movement	B210
Piezo Tip Cleaning and Care	B212
PWR Piezo Reference	B213

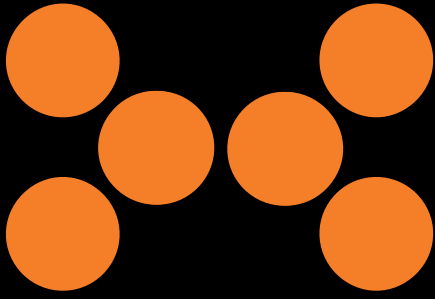

Piezo

Piezoelectric ultrasonic scaling, the dominant technology around the world, is renowned for the gentle yet efficient treatment that it delivers. Discover how our Piezo Tips combine the comfort of piezoelectric scaling with advanced features to elevate your performance and your patients' experience at the same time.



PWR Piezo

Put the PWR in power scaling with the PWR Piezo and PWR Pair Devices and provide a comfortable experience for patients and clinicians. The advanced feedback system gives the clinician perfect control over performance to improve results and increase comfort.



Learn more about all our [PWR Piezo Scaling Devices](#)

PWR Piezo Piezoelectric Scaling Device

Put the PWR in power scaling with the PWR Piezo and provide a comfortable experience for patients and clinicians. The advanced feedback system gives the clinician perfect control over performance to improve results and increase comfort.

Piezo



NEW! PWR Piezo Piezoelectric Scaling Device
UPPIEZO



Did you know? [EverCare Service & Repairs](#) provides regular maintenance, service, and repairs for PWR devices. Learn more by clicking here.

PWR Pair Piezo Scaling & Air Polishing Device

The PWR Pair utilizes PWR Prophylaxis Powder combined with air and water to sub- and supragingivally remove biofilm, and the tough stains caused by everyday foods and beverages. Air polishing also helps remove interproximal biofilm and food debris. The PWR Pair also puts the PWR in power scaling. The Pair's Piezo technology allows for a comfortable experience for patients and clinicians. The advanced feedback system gives the clinician perfect control over performance to improve results and increase comfort.



NEW! PWR Pair Piezo Scaling & Air Polishing Device
APPAIR



Want to know more about PWR Air Polishing? Flip to Page B103



PWR Piezo Accessories included with PWR Piezo and PWR Pair Devices



PWR Piezo LED Handpiece
UPHPLED



PWR Piezo Tip P3
UPP3



PWR Piezo Tip S1-S
UPS1S

• **THE PWR TO CHOOSE**
• For additional PWR Piezo
• Tips sold separately,
• flip to Page B204



PWR Piezo K10 Tip Wrench
UPK10

PWR Foot Pedal	UPFTPEDAL
PWR Piezo Bottle Connection O-Ring Set	UPORING
PWR Plastic Bottle, 500 ml	UPBTL
PWR Bottle Cap, Grey	UPBTLCAPGY
PWR Piezo Peristaltic Water Pump	UPPUMP



PWR Piezo Tips

Your volume of patients varies every day as do their needs. Not all patients are the same. Put the PWR in power scaling with our comprehensive variety of PWR Piezo Tips*, compatible with our PWR Piezo and PWR Pair Devices.

PWR Scaling Piezo Tips

Our selection of PWR Scaling Piezo Tips includes standard piezo tips for calculus removal and biofilm elimination. With six designs to choose from, there is a PWR Piezo Tip no matter the patient.



S1 PWR Piezo Tip
UPS1



S2 PWR Piezo Tip
UPS2



S4 PWR Piezo Tip
UPS4



S1-S PWR Piezo Tip
UPS1S



S3 PWR Piezo Tip
UPS3



S5 PWR Piezo Tip
UPS5



To learn more about PWR Piezo Tip designs, surfaces and treatments by [downloading the PWR Piezo Tip brochure](#) today.



PWR Perio Piezo Tips

Our selection of PWR Perio Piezo Tips includes 10 universal and anatomic piezo tips for calculus and biofilm removal. This diverse collection of PWR Perio Piezo Tip designs is perfect for all of your patients' periodontal treatment needs.



P2 PWR Piezo Tip
UPP2



P10 PWR Piezo Tip
UPP10

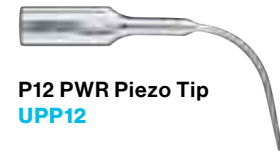

P12 PWR Piezo Tip
UPP12



P3 PWR Piezo Tip
UPP3

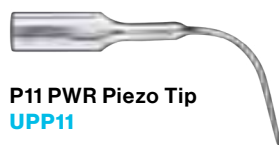

P11 PWR Piezo Tip
UPP11

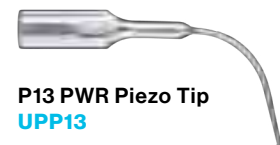

P13 PWR Piezo Tip
UPP13

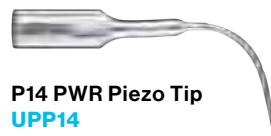

P14 PWR Piezo Tip
UPP14



P16L PWR Piezo Tip
UPP16L



P16R PWR Piezo Tip
UPP16R



P15 PWR Piezo Tip
UPP15

Piezo

PWR Implant Cleaning Piezo Tips

The PWR Implant Cleaning Tip is 100% PEEK (high tech plastics) to safely clean the implant surface. The special shape of the tip holder allows for optional access and a perfect view even in posterior regions.



PWR Piezo Implant Cleaning Tip Holder
UPICTH



PWR piezo Implant Cleaning Tip
(Box of 5)
UPIC1



PWR Endodontic Piezo Tips

Discover the PWR of minimally invasive retrograde root canal preparation. PWR Endodontic Retro Piezo Tips assure a Best in Practice solution to the root canal access issue. Their thin and 90° angled structure allows for a conservative cut through a minimum width bone window. These advantages facilitate wound healing and increase patient comfort.

From exposure and removal of root pins to fast and effective removal of calcification in the coronal third of the root and removal of fractured root inserts—the PWR Endodontic Revision Piezo Tips cover the complete spectrum of endodontic revision treatment.



ER1 PWR Piezo Tip
UPER1



ER4 PWR Piezo Tip
UPER4



RD3 PWR Piezo Tip
UPRD3



ER2 PWR Piezo Tip
UPER2



ER5 PWR Piezo Tip
UPER5



RD4 PWR Piezo Tip
UPRD4



ER3 PWR Piezo Tip
UPER3



RD5 PWR Piezo Tip
UPRD5



To learn more about PWR Piezo Tip designs, surfaces and treatments by [downloading the PWR Piezo Tip brochure](#) today.

PWR Piezo Tip Sets



PWR Piezo Tip Set	UPSETS
Scaling	
S1 PWR Piezo Tip	UPS1
S2 PWR Piezo Tip	UPS2
S3 PWR Piezo Tip	UPS3
S4 PWR Piezo Tip	UPS4
S5 PWR Piezo Tip	UPS5
K10 Tip Wrench (QTY: 5)	UPK10



PWR Piezo Tip Set	UPSETPM
Perio Maintenance	
P10 PWR Piezo Tip	UPP10
P11 PWR Piezo Tip	UPP11
P12 PWR Piezo Tip	UPP12
P13 PWR Piezo Tip	UPP13
P14 PWR Piezo Tip	UPP14
K10 Tip Wrench (QTY: 5)	UPK10

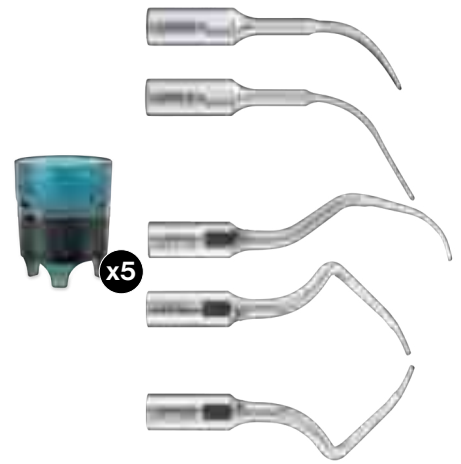

PWR Piezo Tip Set	UPSETPT
Perio Treatment	
P2 PWR Piezo Tip	UPP2
P3 PWR Piezo Tip	UPP3
P15 PWR Piezo Tip	UPP15
P16L PWR Piezo Tip	UPP16L
P16R PWR Piezo Tip	UPP16R
K10 Tip Wrench (QTY: 5)	UPK10



PWR Piezo Tip Set	UPSETM
Maintenance	
S1 PWR Piezo Tip	UPS1
S2 PWR Piezo Tip	UPS2
S5PWR Piezo Tip	UPS5
P2 PWR Piezo Tip	UPP2
P3 PWR Piezo Tip	UPP3
K10 Tip Wrench (QTY: 5)	UPK10

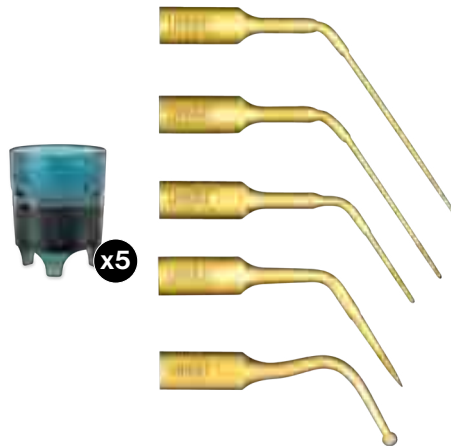

PWR Piezo Tip Set	UPSETER
Endo Revision	
ER1 PWR Piezo Tip	UPER1
ER2 PWR Piezo Tip	UPER2
ER3 PWR Piezo Tip	UPER3
ER4 PWR Piezo Tip	UPER4
ER5 PWR Piezo Tip	UPER5
K10 Tip Wrench (QTY: 5)	UPK10



PWR Piezo Tip Set	UPSETIC
Implant Cleaning	
PWR Piezo Tip	UPIC1
Implant Cleaning (QTY:5)	
PWR Piezo Implant Cleaning Tip Holder	UPICTH
K10 Tip Wrench (QTY: 5)	UPK10



Piezo Tips

Our Symmetry S-Series tips are compatible with Symmetry IQ™ Ultrasonic Scaler along with Satelec® and NSK® devices. E-Series tips are compatible with EMS® handpieces.



Learn more about our [Piezo Tips](#).

Piezo



P Universal Tip

S-Series **USP**

E-Series **UEP**



P10 Tip

S-Series **USP10**

E-Series **UEP10**



P3 Universal Tip

S-Series **USP3**

E-Series **UEP3**



S10 Tip

S-Series **USS10**

E-Series **UES10**



Universal Tip

USU



Replacement S Series Torque Wrench

USRTW



#100 Thin Piezo Tip

S-Series **US100**

E-Series **UE100**



Straight Tip, Diamond Coated

S-Series **US1D**

E-Series **UE1D**



Perio Tip, Left, Diamond Coated

S-Series **US2LD**

E-Series **UE2LD**



Perio Tip, Right, Diamond Coated
S-Series **US2RD**
E-Series **UE2RD**



Perio Tip, Left
US4L



Perio Tip, Right
US4R



After Five™ Tip, Left
USAFL



After Five™ Tip, Right
USAFR



After Five™ Tip, Straight
USAFS



Piezo Reference Guide

Piezo

Characteristics of Tip Movement

The smooth linear movement generated by piezoelectric systems creates a stroke pattern that is similar to hand instrumentation. Adapting the lateral surface of the piezo tip against the tooth surface (similar to a hand instrument) will increase clinical efficiency.

Essentials of Power Dispersion

- Most of the energy is dispersed at the point of tip (1).
- The lateral surfaces of the tip (2) are moving in a linear pattern, similar to the stroke of a bladed hand instrument.
- Adaptation of this lateral surface provides the most efficient deposit removal.
- Adapt the terminal 2–3 mm of tip for optimal performance.
- When concave front or convex back surfaces (3) are adapted to the tooth surface, the instrument will chatter against the surface rather than effectively remove deposit.

Power Dispersion

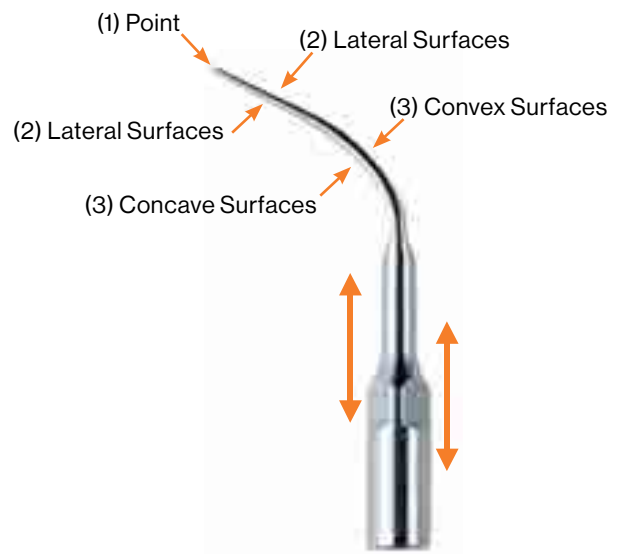



Piezo Tip Adaptation

- Adapt the lateral surface to the tooth for optimal performance.
- Maintain tip angulation near zero degrees — parallel to tooth surface.
- To minimize the risk of root damage, never adapt tip at a 90° angle.
- Use little or no lateral pressure and let the tip do the work for you.
- When concave front or convex back surfaces are adapted to the tooth surface, the instrument will chatter against the surface rather than effectively instrument.

Sensory Observations

- Smooth vibration enhances tactile sense for instrumentation.
- The smooth motion of the tip is an excellent option for patients with root sensitivity.
- Piezo tip vibration is very smooth and quiet when adapted correctly on a lateral surface.
- Deposits are pulverized, resulting in a slurry of debris that is visible in the water at the back of the mouth.
- Calculus is generally not removed in big chunks as commonly seen during magnetostrictive instrumentation.



Lateral surface of tip in use

- **Best in Practice Fact**
- To achieve the greatest efficiency and patient comfort, it is best to adapt the lateral sides of your piezoelectric instrument to the surface of the tooth.



Piezo Tip Cleaning and Care

Cleaning & Sterilization

- Piezo tips remain in the Piezo Torque Wrench during the complete cleaning, disinfection and sterilization reprocessing cycle.
- Clean using ultrasonic cleaner or thermodisinfector.
- Steam sterilize for at least 4 minutes at 270°F/132°C or 30 minutes at 250°F/121°C. Do not heat above 275°F/135°C.
- Recommend at least 30 minute dry time after sterilization cycle.
- Clean, disinfect, inspect and steam sterilize before each use following the respective equipment manufacturer's users instructions.
- Do not expose to phenols, iodophors or dry heat sterilization.
- Detailed care and maintenance instructions are available upon request or go to Hu-Friedy.com.

Tip Installation

1. Your Hu-Friedy Piezo tip comes with its own Piezo Torque Wrench.
2. Attach tip to handpiece using the Piezo Torque Wrench by aligning the threaded end of the tip to the handpiece.
3. Rotate the Piezo Torque Wrench clockwise. Once the instrument is screwed all the way in, give an extra quarter of a turn to obtain the required torque. Incomplete tightening may cause the tip to become loose or lack vibration.
4. When using the Piezo Torque Wrench without a tip previously inserted into the tip carrier, take the following step: place the Piezo Torque Wrench over the tip by slipping tip through the small hole in the bottom, closed end of the tool. This will position the tip within the Piezo Torque Wrench for safety and convenience.

Application Chart	S10	U	100	P10	P3	4R 4L	1D	2RD 2LD	P	AFS AFL AFR
Light to moderate supragingival deposits	•	•	•		•					•
Heavy supragingival deposits	•			•						•
Light to moderate deposits in shallow pockets		•	•		•		•		•	•
Light to moderate deposits in deep periodontal pockets					•		•	•		•
Moderate to heavy deposits in deep periodontal pockets						•				
Furcation areas								•		•

Tip Removal

1. Hold the handpiece vertically. Insert the tip through the hole in the bottom of the Piezo Torque Wrench.
2. Depress wrench slightly while rotating to fully secure tip to wrench.
3. Turn the wrench counter-clockwise to loosen and remove tip from handpiece.
4. Once removed from handpiece, do not remove the tip from the wrench carrier.

Replacement of Worn Tips Actual Size Guide

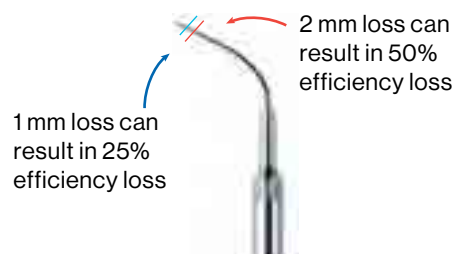

Optimum Efficiency

Scaling efficiency can significantly diminish with worn tips. Inferior performance and poor water delivery can result from worn, damaged, bent, or altered tips. For optimal scaling efficiency, we recommend checking tips regularly for signs of wear.



PWR Piezo Reference

PWR Piezo Power Settings Reference

Tip	PWR Piezo	PWR Pair
	Recommended Power Setting (Perio/Scaler Mode)	
Scaling		
UPS1S	1-2*	1-2*
UPS1 - UPS2 - UPS3 - UPS4 - UPS5	1-6*	1-5*
Perio		
UPP2 - UPP3 - UPP10 - UPP11 - UPP12 - UPP13 - UPP14	1-3*	1-3*
UPP15 - UPP16R - UPP16L	1-3*	1-3*
Implant Cleaning		
UPICTH + UPIC1	1-2*	1-2*
Endo Revision		
UPER1	1-6	1-5
UPER2 - UPER3 - UPER4 - UPER5	1-3	1-3
Endo Retro		
UPRD3 - UPRD4 - UPRD5	1-3	1-3

*Can be used with or without "soft mode" function.

S-Series Power Settings Cross Reference

Hu-Friedy	Application				Power Setting				
	Hu-Friedy	Satelec	Nsk	Power	Hu-Friedy Symmetry	Satelec P5	Satelec Sp Neutron	Nsk Varios	
USS10	Scaling	Scaling	Scaling	MED	● 2-8 ● 1-4	7-9	8-10	Min-3	
USP10	Scaling	Scaling	Scaling	MED	● 1-4	7-8	8-10	Min-3	
USP	Scaling	Scaling	Scaling	MED	● 2-10 ● 1-4	7-9	8-10	Min-3	
US100	Scaling	Scaling	Scaling	MED	● 4-10 ● 1-3	4-6	6-8	Min-1	
USU	Scaling	Scaling	Scaling	MED	● 4-10 ● 1-3	7-8	1-6	Min-4	
USAFS	Scaling	Scaling	Scaling	MED	● 1-5	7-8	8-10	Min-3	
USAFL	Scaling	Scaling	Scaling	MED	● 1-5	7-8	8-10	Min-3	
USAFR	Scaling	Scaling	Scaling	MED	● 1-5	7-8	8-10	Min-3	
USP3	Perio	Perio	Perio	LOW	● 4-10	1-3	1-4	Min-4	
US4R	Perio	Perio	Perio	LOW	● 6-10				
US4L	Perio	Perio	Perio	LOW	● 1-6				
US1D	Perio	Perio	Perio	LOW	● 7-10 ● 1-6				
US2RD	Perio	Perio	Perio	LOW	● 1-5	1-3	1-4	Min-4	
US2LD	Perio	Perio	Perio	LOW	● 1-5	1-3	1-4	Min-4	

Hu-Friedy S-Series Item Code Cross Reference

Hu-Friedy	USS10	US100	USP10	USP	USU	USP3	US4R	US4L	US1D	US2RD	US2LD	USAFS	USAFL	USAFR
Nsk Varios	G1	G6	G4	G5	P20	P10				PD3	PD2	P20	P21L	P21R
Satelec	S1	10Z	10P	1S	PFU	H3	H4R	H4L	H1	H2R	H2L			

Piezo

Insert Options	B302
Magnetostrictive Insert Designs	B302
Swivel Inserts	B304
Swivel Direct Flow™ Inserts	B304
Satin Swivel Inserts	B306
Power Plus Inserts	B306
Ultrasonic Insert Kits	B307
Non-Swivel Inserts	B308
Streamline™ Classic Inserts	B308
Original Prophy and Prophy Plus Inserts	B308
After Five™ and After Five™ Plus Inserts	B309
Streamline™ Direct Flow Inserts	B309
Streamline™ Plus Inserts	B310
Accessories	B311
Insert Wear Guide	B312
Magnetostrictive Cross Reference Guide	B313

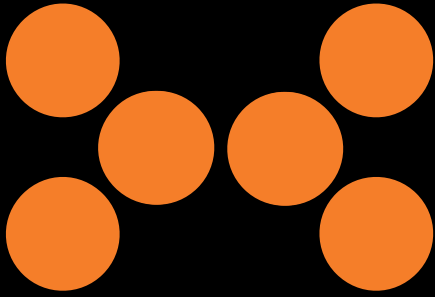

Magneto

Our ultrasonic inserts combine the power, efficiency, and comfort you need to treat a wide range of patients. Available in a variety of different options for tip design, handle style, frequency, and water delivery method, Our ultrasonic inserts allow you to perform at your best.



Insert Options

Our Magneto Ultrasonic Inserts portfolio includes an array of different types of Inserts. Whether choosing a swivel-based Insert or non-swivel, you will find the Insert perfect for you to help you be **The Best in Practice.**

Magnetostrictive Insert Designs

Magneto



Swivel Direct Flow™ Inserts



Swivel™ Inserts



Streamline™ Plus Inserts



Streamline™ Direct Flow Inserts



Streamline™ Inserts



Original Prophy Plus and After Five™ Plus Inserts



Original Prophy and After Five™ Inserts

Replacement O-Rings	
Swivel & Non-Swivel Inserts (package of 12 o-rings)	UBLKORING
Original Prophy Inserts (package of 12 o-rings)	UGRNORING



Swivel Inserts

The only insert that unlocks 360° rotation, Swivel gives you the maneuverability and adaptability you want when power scaling. With a slight rolling motion of your fingertips you can eliminate the “start, stop, readjust, start” routine required with traditional inserts.



Learn more about all our [Ultrasonic Insert](#) portfolio.

Swivel Direct Flow™ Inserts

Magneto



#10 Swivel Direct Flow™ Insert

25 kHz	UI25SD10
30 kHz	UI30SD10



#100 Thin Swivel Direct Flow™ Insert

25 kHz	UI25SD100
30 kHz	UI30SD100



#1000 Triple Bend Swivel Direct Flow™ Insert

25 kHz	UI25SD1000
30 kHz	UI30SD1000



After Five™ Swivel Direct Flow™ Insert, Left

25 kHz **UI25SDL**

30 kHz **UI30SDL**



After Five™ Swivel Direct Flow™ Insert, Right

25 kHz **UI25SDR**

30 kHz **UI30SDR**



After Five™ Swivel Direct Flow™ Insert, Straight

25 kHz **UI25SDS**

30 kHz **UI30SDS**



After Five™ Swivel Direct Flow™ Insert Set

25 kHz **UI25SDSET**

30 kHz **UI30SDSET**



XT Triple Bend Swivel Direct Flow™ Insert

30 kHz **UI30SDXTTB**



Satin Swivel Inserts



#10 Universal Swivel Insert	
25 kHz	UI25SS10
30 kHz	UI30SS10



#100 Thin Swivel Insert	
25 kHz	UI25SS100
30 kHz	UI30SS100



#1000 Triple Satin Swivel Insert	
25 kHz	UI25SS1000
30 kHz	UI30SS1000



Swivel XT Insert	
25 kHz	UI25SSXT
30 kHz	UI30SSXT

Magneeto

Power Plus Inserts

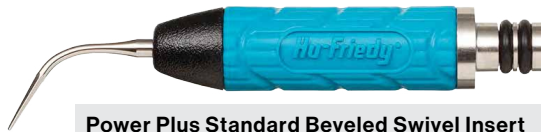

Power Plus Standard Beveled Swivel Insert	
30 kHz	UI30PPSB



Power Plus Standard Conical Swivel Insert	
30 kHz	UI30PPSC



Power Plus Thin Beveled Swivel Insert	
30 kHz	UI30PPTB



Power Plus Thin Conical Swivel Insert	
30 kHz	UI30PPTC

Ultrasonic Insert Kits



Ultrasonic Kit #10 Universal

IMINSRT10

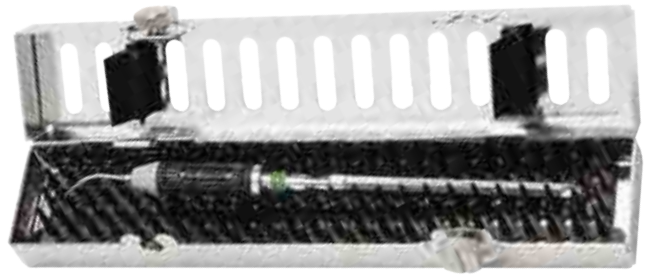

Ultrasonic Kit #100 Thin

IMINSRT100



Ultrasonic Kit #1000 Triple Bend

IMINSR1000



Ultrasonic Kit XT Triple Bend Insert

IMINSRTXTB

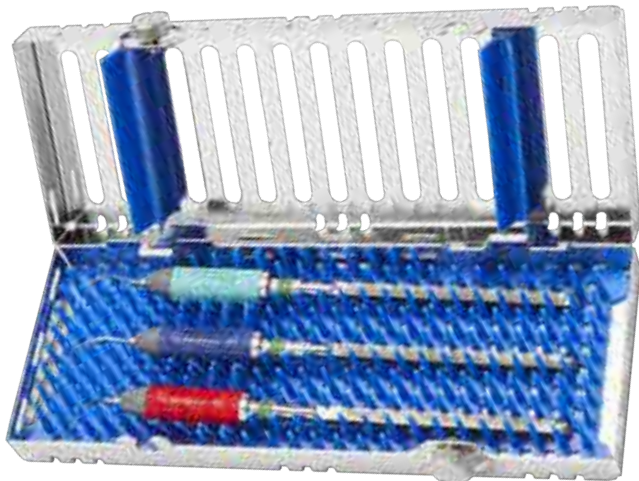

Ultrasonic Insert Kit Left/Right/Straight
Includes Left, Right, and Straight

IMINSRTSET

Magneto



Non-Swivel Inserts

We offer a wide variety of both color-coded resin as well as steel Non-Swivel Inserts that feature through-tip or fixed water delivery.



Not sure which Insert to choose?
We make the decision making easy.

Magneto

Streamline™ Classic Inserts



#1000 Triple Bend Streamline™ Insert

25 kHz [UI100025K](#)
30 kHz [UI100030KX](#)



#10 Universal Streamline™ Insert

25 kHz [UI1025K](#)
30 kHz [UI1030KX](#)



#100 Thin Universal Streamline™ Insert

25 kHz [UI25K100S](#)
30 kHz [UI30K100SX](#)



#3 Beavertail Streamline™ Insert

25 kHz [UI325K](#)
30 kHz [UI330KX](#)

Original Prophy and Prophy Plus Inserts



#10 Original Prophy Style Insert

25 kHz [UI25KP10](#)
30 kHz [UI30KP10](#)



#10 Prophy Plus Insert

25 kHz [UI25KP10P](#)
30 kHz [UI30KP10P](#)



After Five™ and After Five™ Plus Inserts

After Five™ Plus Insert - Left	
25 kHz	UI25KSF10L
30 kHz	UI30KSF10L

After Five™ Plus Insert - Right	
25 kHz	UI25KSF10R
30 kHz	UI30KSF10R

After Five™ Plus Insert - Straight	
25 kHz	UI25KSF10S
30 kHz	UI30KSF10S

After Five™ Plus Inserts - Set	
25 kHz	UI25KSFSET
30 kHz	UI30KSFSET

After Five™ Insert - Left	
25 kHz	UI25KSL10L
30 kHz	UI30KSL10L

After Five™ Insert - Right	
25 kHz	UI25KSL10R
30 kHz	UI30KSL10R

After Five™ insert - Straight	
25 kHz	UI25KSL10S
30 kHz	UI30KSL10S

After Five™ Inserts - Set	
25 kHz	UI25KSLSET
30 kHz	UI30KSLSET

Streamline™ Direct Flow Inserts



10 Universal Streamline™ Direct Flow Insert	
25 kHz	UI25SF10
30 kHz	UI30SF10



100 Thin Streamline™ Direct Flow Insert	
25 kHz	UI25SF100
30 kHz	UI30SF100



1000 Triple Streamline™ Direct Flow Insert	
25 kHz	UI25SF1000
30 kHz	UI30SF1000



Streamline™ Direct Flow Insert, Left	
25 kHz	UI25SFL
30 kHz	UI30SFL



Streamline™ Direct Flow Insert, Right	
25 kHz	UI25SFR
30 kHz	UI30SFR



Streamline™ Direct Flow Insert, Straight

25 kHz	UI25SFS
30 kHz	UI30SFS



Streamline™ Direct Flow Insert Set

25 kHz	UI25SFSET
30 kHz	UI30SFSET



Streamline™ Direct Flow Insert

30 kHz	UI30SFXT
--------	--------------------------



XT Triple Bend Streamline™ DF Insert

30 kHz	UI30SFXTTB
--------	----------------------------

Magneto

Streamline™ Plus Inserts



Streamline™ Plus #10 Insert

30 kHz	UI30SP10
--------	--------------------------



Streamline™ Plus #100 Insert

30 kHz	UI30SP100
--------	---------------------------



Streamline™ Plus #1000 Insert

30 kHz	UI30SP1000
--------	----------------------------



Streamline™ Plus Left Insert

30 kHz

UI30SPL



Streamline™ Plus Right Insert

30 kHz

UI30SPR



Streamline™ Plus Straight Insert

30 kHz

UI30SPS



Streamline™ Plus XTTB Insert

30 kHz

UI30SPXTTB

Accessories



Ultrasonic Insert O-Rings

QTY: 12

Black

UBLKORING

Green

UGRNORING



Learn more about all the different types of **Ultrasonic Inserts** we offer.

Insert Wear Guide

Worn tips can diminish your scaling efficiency. Check your inserts every week to maintain optimal performance.

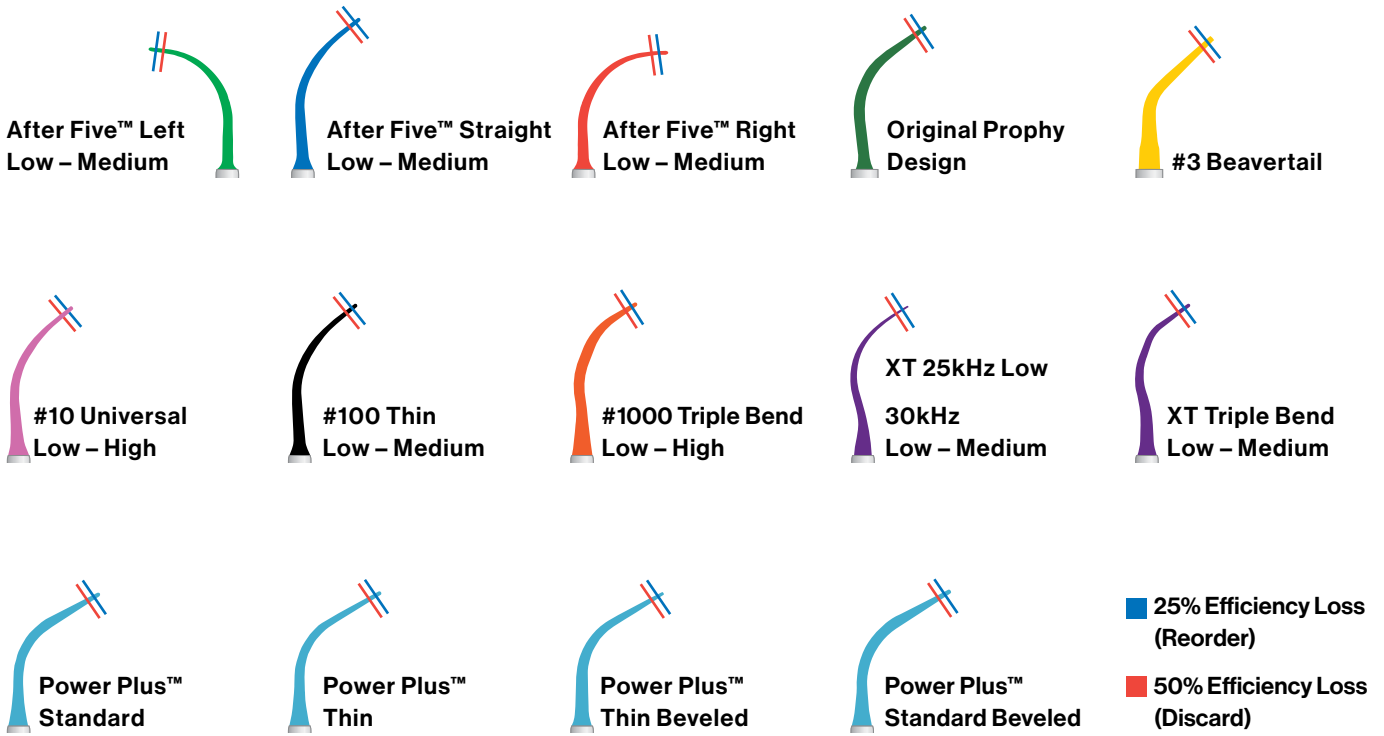

Magneeto

How To Use Your Wear Guide

1. Locate the diagram of the insert to be measured (use color as guide).
2. Position point **A** to point **B** as shown and/or align the curvature of the tip (circled) to match the guide.
3. Rotate insert until tip is flat against the card.
4. Evaluate tip condition, comparing length to red/blue bars.

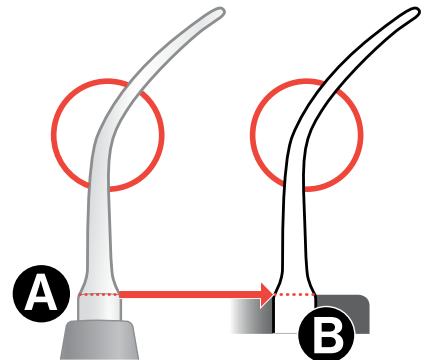

Reorder tips when 25% efficiency loss (blue bar)

Discard tip when 50% efficiency loss (red bar)



Download and print your own
[Inserts Wear Guide.](#)

Magnetostrictive Cross Reference Guide

Hu-Friedy Ultrasonic Inserts

Tip Style	Handle Color	25 kHz	30 kHz
Swivel			
#10 Universal	Lavender	UI25SS10	UI30SS10
#100 Thin	Black	UI25SS100	UI30SS100
#1000 Triple Bend	Orange	UI25SS1000	UI30SS1000
Swivel XT	Purple	UI25SSXT	UI30SSXT

Swivel Direct Flow

#10 Universal	Lavender	UI25SD10	UI30SD10
#100 Thin	Black	UI25SD100	UI30SD100
#1000 Triple Bend	Orange	UI25SD1000	UI30SD1000
XT Triple Bend	Purple	UI25SDXTTB	UI30SDXTTB
After Five Straight	Dark Blue	UI25SDS	UI30SDS
After Five Right	Red	UI25SDR	UI30SDR
After Five Left	Green	UI25SDL	UI30SDL
Set of 3 ¹	Dark Blue Red Green	UI25SDSET	UI30SDSET

Streamline Direct Flow

#10 Universal	Lavender	-	UI30SF10
#100 Thin	Black	-	UI30SF100
#1000 Triple Bend	Orange	-	UI30SF1000
XT Triple Bend	Purple	-	UI30SFXTTB
After Five Straight	Dark Blue	-	UI30SFS
After Five Right	Red	-	UI30SFR
After Five Left	Green	-	UI30SFL
Set of 3 ¹	Dark Blue Red Green	-	UI30SFSET

Streamline

#10 Universal	Lavender	UI1025K	UI1030K
#100 Thin	Black	UI25K100S	UI30K100S
#1000 Triple Bend	Orange	UI100025K	UI100030K
#3 Beavertail	Yellow	UI325K	UI330K

Original Prophy Designs

#10 Universal	Metal	UI25KP10	UI30KP10
#10 Universal PLUS	Green	UI25KP10P	UI30KP10P

After Five – Periodontal Debridement

After Five Straight	Metal	UI25KSL10S	UI30KSL10S
After Five Right	Metal	UI25KSL10R	UI30KSL10R
After Five Left	Metal	UI25KSL10L	UI30KSL10L
Set of 3 ¹	Metal	UI25KSLSET	UI30KSLSET

Dentsply Cavitron² Inserts

Tip Style	25 kHz	30 kHz
TFI #10 Straight	Grey	Black
TFI #1000 Straight Triple	Grey	Black
CTI-10S THINsert		Purple

FSI-10	Dark Blue	Dark Blue
FSI-SLI 10S	Green	Green
FSI-1000	Dark Blue	Dark Blue
FSI-SLI-1000	Green	Green
FSI-SLI 10S	Green	Green
FSI-SLI 10R	Green	Green
FSI-SLI 10L	Green	Green
FSI-SLI Assorted	Green	Green

FSI-10	-	Dark Blue
FSI-SLI 10S	-	Green
FSI-1000	-	Dark Blue
FSI-SLI-1000	-	Green
FSI-SLI 10S	-	Green
FSI-SLI 10R	-	Green
FSI-SLI 10L	-	Green
FSI-SLI Assorted	-	Green

TFI #10 Straight	Grey	Black
TFI #1000 Straight Triple	Grey	Black
Bend TFI #3 Thin Beavertail	Grey	Black

Classic “P10”

	Metal	Metal
--	-------	-------

SLI Slimline²

SLI-10S	Metal	Metal
SLI-10R	Metal	Metal
SLI-10L	Metal	Metal
SLI-10 3 pack	Metal	Metal

IMPORTANT NOTE: Hu-Friedy and Dentsply are competitors. This chart is not intended to suggest that the respective Dentsply and Hu-Friedy ultrasonic inserts are equivalent or comparable. Instead, this chart suggests an alternative Hu-Friedy brand ultrasonic insert based on the experience and recommendations of clinicians who have previously used the listed Dentsply inserts. Cavitron and Dentsply are registered trademarks of Dentsply Sirona.

Clinicians who use FSI[®] and Focused Spray[®] and FSI-SLI Focused Spray Slimline inserts may consider Swivel Direct Flow or Streamline Direct Flow as an alternative.²

- 1) Set of 3 includes a straight, right and left.
- 2) Dentsply, Cavitron, Slimline, Thru Flow, Classic “P”, TFI, SLI, FSI and Focused Spray are trademarks of DENTSPLY Sirona, Inc.



Note: some of the devices, products, and/or programs advertised may not be licensed for sale outside the United States. Contact your local sales or customer care representative for availability details. For full product warranty details, please visit [HuFriedyGroup.com/services/warranties](https://www.hufriedy.com/services/warranties)

The contents of this catalog including, but not limited to, all text, photographs and graphics, are the sole and exclusive property of Hu-Friedy Mfg. Co., LLC its affiliates or related companies and may not be copied, reproduced or distributed without prior written permission.

Hu-Friedy Mfg. Co., LLC, 1666 E. Touhy Ave., Des Plaines, IL 60018 | [HuFriedyGroup.com](https://www.hufriedy.com)

All company and product names are trademarks of Hu-Friedy Mfg. Co., LLC its affiliates or related companies, unless otherwise noted. STATIM® is a registered trademark of SciCan Ltd. Midmark® is a registered trademark of Midmark Corporation. Steelgard® is a registered trademark of Harry Miller Corp. Wash-Checks® is a registered trademark of SteriTec Products Mfg. Co., Inc. Sterillium Comfort Gel® is a registered trademark of Bode Chemie GmbH Co.



Infection Prevention & Instrument Management

Infection prevention is the cornerstone of every successful dental practice. While transmission of infectious agents and diseases in the dental setting is rare, it does happen, which is why it's critical to continually reinforce the importance of best practices and industry standards. We have the solutions you need to create a culture of safety, compliance, and efficiency at your office.

Instrument Management	C101
Instrument Reprocessing & Sterilization	C201
Personal Protective Equipment	C301

The Benefits of the Instrument Management System	C102
Saving with IMS	C103
IMS™ Infiniy Series™ Points of Performance	C104
Cassettes & Accessories	C105
Infinity Series™ & Signature Series™ Cassettes	C105
Accessories & Organization Products	C115
Cassette Replacement Parts	C120
Procedural Kits	C130
ADA CDT Coding Collection Series	C143
Procedural Tubs	C146
Organizational Tubs	C146
Tub Accessories	C148

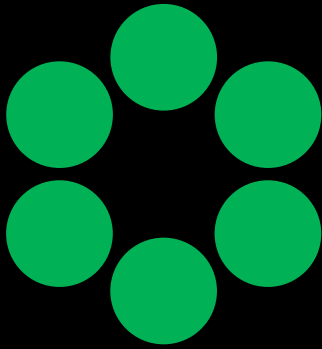

Instrument Management

Our cassette-based Instrument Management System (IMS) allows you to move instruments from cleaning to chairside efficiently and safely through reduced handling of contaminated instruments. By removing multiple time-consuming and potentially dangerous steps in the process, IMS™ Cassettes can save your facility five to ten minutes per procedure, reduce the chance of sharps injuries, and protect your bottom line through instrument integrity and increased productivity - all while promoting compliance to infection prevention standards of care.



The Benefits of the Instrument Management System

1. Chairside: Patient Preview & Presentation

- Organize instruments according to procedure, allowing for more focus on patients and less time spent searching for missing instruments.
- Neatly organized instruments offer a more relaxed and professional appearance to help ease patient anxiety and enhance referrals.

2. Cleaning: Processed & Prepped

- Instruments are kept together throughout cleaning, rinsing and drying, reducing the potential for breakage or loss.
- Handling of instruments is virtually eliminated, saving time and increasing safety.

3. Sterilization: Wrapped & Ready

- Instruments properly separated on rails and held in cassettes, help prevent overloading of the sterilizer and support an optimal environment for sterilization.
- Handling only wrapped cassettes provides a safer and more efficient protocol.

4. Storage: Neat & Complete

- Ready for use or storage until needed for increased time savings.
- Complete procedural set-ups make it simple for onboarding or for anyone to set up or turn over a treatment.



Learn more about
[Whats inside IMS.](#)

Saving with IMS

Save Time

The sterilization area is the heart of a dental clinic, where everything, and everyone flows in and out. An inefficient sterilization area will impact the entire practice. Facilities that implement IMS cassettes, eliminate time consuming and dangerous steps that add up to a savings of 5 to 10 minutes per procedure – up to an hour or more a day.

MANUAL		IMS
 SHARPS HAZARD!	Hand Scrub/ Ultrasonic	
	Rinse	
	Disinfect Tray	
	Dry	
 SHARPS HAZARD!	Sort Instruments	
 SHARPS HAZARD!	Pouch/Wrap	
	Autoclave & Store	
 SHARPS HAZARD!	Prep Tray/Find Instruments	
	Chairside	

Save Space

Below, learn about space requirements and counter space needed for IMS Cassettes vs. traditional trays.

	Cassettes	Trays
Instrument Break Down Area	12"	36"
Ultrasonic Cleaner Area	24"	24"
Sink	24"	24"
Drying and Packaging	18"	36"
Handpiece Maintenance	12"	12"
Sterilizer	24"	24"
Tray Assembly and Storage	18"	36"
Total Space	11 feet	16 feet

	Cassettes	Trays
4-6 Operatories (Stericenter)	11 feet	16 feet
7-8 Operatories (Stericenter)	13 feet	19 feet
9 or More	15 feet	22 feet



Save Money with IMS using our [IMS Savings Calculator](#).



IMS™ Infiniy Series™ Points of Performance

Ergonomic latch with positive locking mechanism is safe and easy-to-use, allows one-handed opening and visual confirmation if the cassette is locked/unlocked.

Revolutionary new hole pattern design provides more access to instruments during cleaning and sterilization and increases compatibility with today's cleaning equipment, including automated washers.

Innovative color-coded silicone rail system, available in 11 color options, significantly reduces instrument contact, allowing for more water flow while protecting the instruments during reprocessing.

High quality, electropolished stainless steel protects against corrosion while providing a professional appearance.

Smooth round corners and slotted edges increase drainage and reduce drying time.

Beveled edge allows for a more ergonomic grasp.

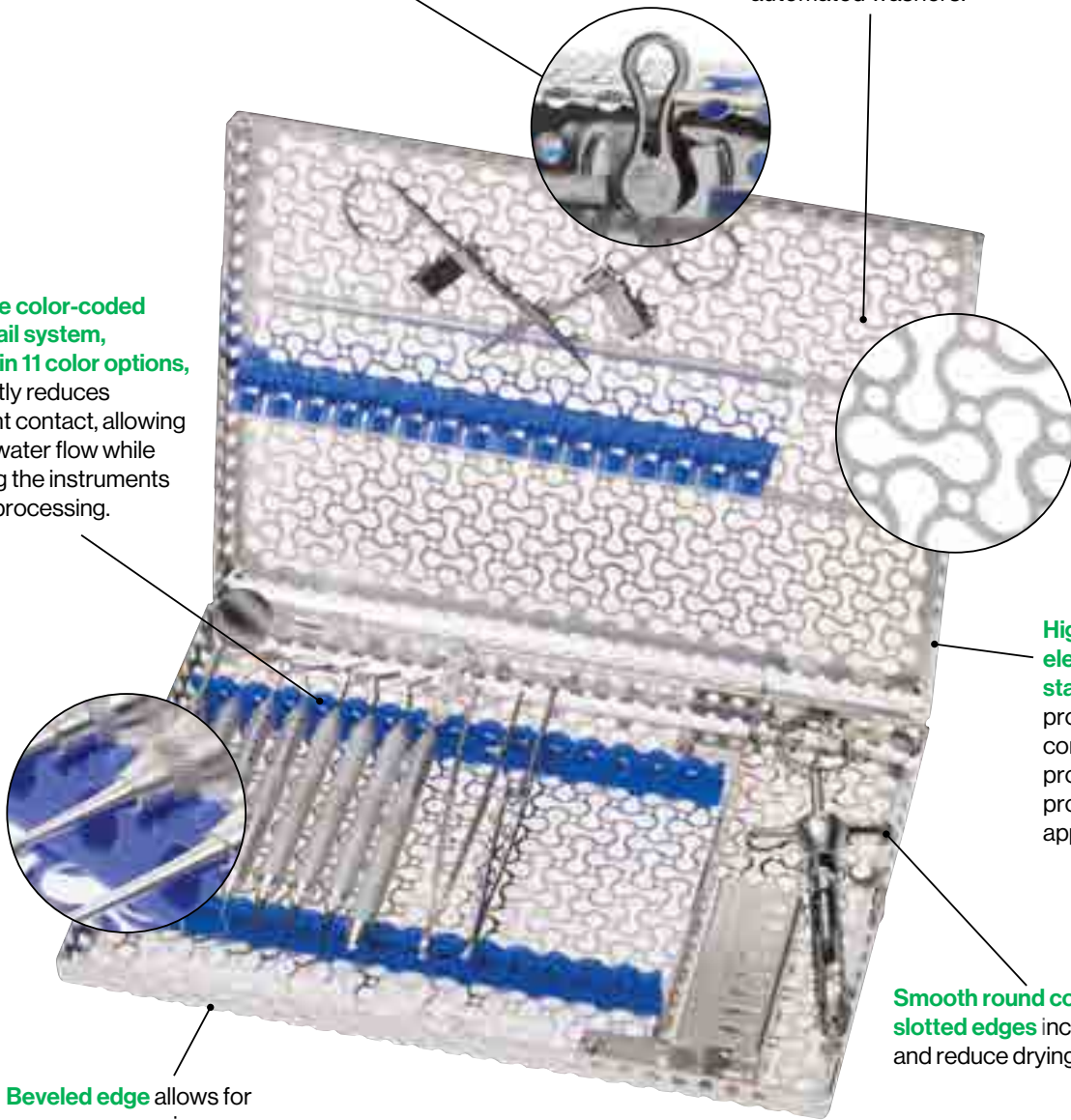



Cassettes & Accessories

Infinity Series™ and Signature Series™ Cassettes are manufactured from high quality, electropolished stainless steel shells to protect against corrosion while providing a long-lasting, professional appearance. IMS™ Cassettes feature medical-grade silicone rails, robust and ergonomic latches with positive locking mechanism, and are available in multiple sizes and colors that can be configured to best fit the needs of your facility.



Learn more about our [Cassette](#) portfolio.

Infinity Series™ & Signature Series™ Cassettes

Exam Cassette



Exam Cassette - 5 Instrument		
<i>Holds 5 instruments</i>		
3" x 8" x 1.25" (76 mm x 203 mm x 32 mm)		
	Infinity Series	Signature Series
● Red	IMN6050	IM6050
● Gray	IMN6051	IM6051
○ White	IMN6052	IM6052
● Orange	IMN6053	IM6053
● Purple	IMN6054	
● Yellow	IMN6055	IM6055
● Lavender	IMN6056	IM6056
● Black	IMN6057	
● Blue	IMN6058	IM6058
● Green	IMN6059	IM6059
● Ocean Blue	IMN60511	



Learn more about our [Instrument Management System](#) and request a consultation today.



Small Cassettes



Small Cassette - 8 Instrument

Holds 8 instruments with an accessory area.
5.5" x 8" x 1.25" (140 mm x 203 mm x 32 mm)

	Infinity Series	Signature Series
● Red	IMN5080	IM5080
● Gray	IMN5081	IM5081
○ White	IMN5082	IM5082
● Orange	IMN5083	IM5083
● Purple	IMN5084	
● Yellow	IMN5085	IM5085
● Lavender	IMN5086	IM5086
● Black	IMN5087	
● Blue	IMN5088	IM5088
● Green	IMN5089	IM5089
● Ocean Blue	IMN50811	



Small Cassette - 10 Instrument

Holds 10 instruments. No accessory area.
5.5" x 8" x 1.25" (140 mm x 203 mm x 32 mm)

	Infinity Series	Signature Series
● Red	IMN5100	IM5100
● Gray	IMN5101	IM5101
○ White	IMN5102	IM5102
● Orange	IMN5103	IM5103
● Purple	IMN5104	
● Yellow	IMN5105	IM5108
● Lavender	IMN5106	IM5106
● Black	IMN5107	
● Blue	IMN5108	IM5108
● Green	IMN5109	IM5109
● Ocean Blue	IMN51011	

Space Saver Seven Cassettes



Space Saver Seven Signature Series™ Cassette

Space Saver Seven Cassettes hold 7 instruments and their compact dimensions help to minimize space constraints in processing equipment.
4.5" x 8" x 1" (114 mm x 203 mm x 25 mm)

● Red	IMSS70
● Gray	IMSS71
○ White	IMSS72
● Orange	IMSS73
● Yellow	IMSS75
● Lavender	IMSS76
● Blue	IMSS78
● Green	IMSS79



12 Instrument Signa-Stat Cassette



Signa-Stat Cassette - 12 Instrument

Holds 12 instruments with an accessory area. Compatible with SciCan® STATIM® Autoclave or Midmark® M3 Autoclave.
6.5" X 10.5" X 1.25" (165 mm x 267 mm x 32 mm)

	Infinity Series	Signature Series
● Red	IMN8120	IM8120
● Gray	IMN8121	IM8121
○ White	IMN8122	IM8122
● Orange	IMN8123	IM8123
● Purple	IMN8124	
● Yellow	IMN8125	IM8125
● Lavender	IMN8126	IM8126
● Black	IMN8127	
● Blue	IMN8128	IM8128
● Green	IMN8129	IM8129
● Ocean Blue	IMN81211	

Large Cassettes



Large Cassette With Accessory Area - 12 Instrument

Holds 12 instruments with large accessory area.
8" X 11" X 1.25" (203 mm x 280 mm x 32 mm)

	Infinity Series	Signature Series
● Red	IMN4120	IM4120
● Gray	IMN4121	IM4121
○ White	IMN4122	IM4122
● Orange	IMN4123	IM4123
● Purple	IMN4124	
● Yellow	IMN4125	IM4125
● Lavender	IMN4126	IM4126
● Black	IMN4127	
● Blue	IMN4128	IM4128
● Green	IMN4129	IM4129
● Ocean Blue	IMN41211	



Large Cassette With Accessory Area - 16 Instrument
Holds 16 instruments with large accessory area.
8" X 11" X 1.25" (203 mm x 280 mm x 32 mm)

	Infinity Series	Signature Series
● Red	IMN4160	IM4160
● Gray	IMN4161	IM4161
○ White	IMN4162	IM4162
● Orange	IMN4163	IM4163
● Purple	IMN4164	
● Yellow	IMN4165	IM4165
● Lavender	IMN4166	IM4166
● Black	IMN4167	
● Blue	IMN4168	IM4168
● Green	IMN4169	IM4169
● Ocean Blue	IMN41611	



Large Cassette With Accessory Area - 20 Instrument
Holds 20 instruments with large accessory area.
8" X 11" X 1.25" (203 mm x 280 mm x 32 mm)

	Infinity Series	Signature Series
● Red	IMN4200	IM4200
● Gray	IMN4201	IM4201
○ White	IMN4202	IM4202
● Orange	IMN4203	IM4203
● Purple	IMN4204	
● Yellow	IMN4205	IM4205
● Lavender	IMN4206	IM4206
● Black	IMN4207	
● Blue	IMN4208	IM4208
● Green	IMN4209	IM4209
● Ocean Blue	IMN42011	



Oral Surgery Cassettes



Oral Surgery Cassette

Accommodates 12 hand instruments, 4 elevators, 3 hinged instruments in the lid and a large accessory area. Hinged instruments should be in open position. Fits in most 10" chamber or larger sterilizers, most instrument washers, and larger ultrasonic baths. 8" X 14.5" X 1.25" (203 mm x 368 mm x 32 mm)

	Infinity Series	Signature Series
● Red	IMNOS0	IMOS0
● Gray	IMNOS1	IMOS1
○ White	IMNOS2	IMOS2
● Orange	IMNOS3	IMOS3
● Purple	IMNOS4	
● Yellow	IMNOS5	IMOS5
● Lavender	IMNOS6	IMOS6
● Black	IMNOS7	
● Blue	IMNOS8	IMOS8
● Green	IMNOS9	IMOS9
● Ocean Blue	IMNOS11	

Instrument Management

Double-Decker™ Cassettes



Double-Decker™ Cassette - 8 Instrument

Two-Tier cassettes, holds 4 instruments on each side for a total of 8 instruments.

3" X 8" X 1.5" (76 mm x 203 mm x 38 mm)

	Infinity Series	Signature Series
● Red	IMN9080	IM9080
● Gray	IMN9081	IM9081
○ White	IMN9082	IM9082
● Orange	IMN9083	IM9083
● Purple	IMN9084	
● Yellow	IMN9085	IM9085
● Lavender	IMN9086	IM9086
● Black	IMN9087	
● Blue	IMN9088	IM9088
● Green	IMN9089	IM9089
● Ocean Blue	IMN90811	



Double-Decker™ Cassette - 14 Instrument

Two-Tier cassettes, holds 7 instruments on each side for a total of 14 instruments.

4.5" X 8" X 1.5" (114 mm x 203 mm x 38 mm)

	Infinity Series	Signature Series
● Red	IMN9140	IM9140
● Gray	IMN9141	IM9141
○ White	IMN9142	IM9142
● Orange	IMN9143	IM9143
● Purple	IMN9144	
● Yellow	IMN9145	IM9145
● Lavender	IMN9146	IM9146
● Black	IMN9147	
● Blue	IMN9148	IM9148
● Green	IMN9149	IM9149
● Ocean Blue	IMN91411	

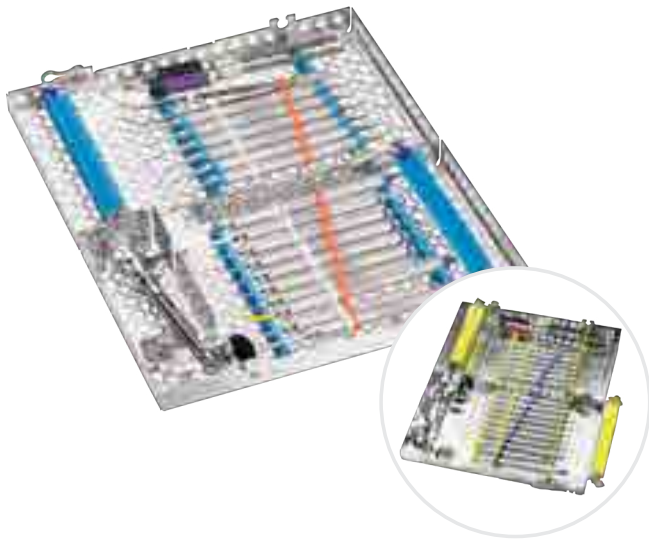

Double-Decker™ Cassette - 20 Instrument

Two-Tier cassettes, holds 10 instruments on each side for a total of 20 instruments. Features an accessory area with a built-in needle cap holder and slot for a winged syringe.

6" X 9.7" X 1.5" (152 mm x 246 mm x 38 mm)

	Infinity Series	Signature Series
● Red	IMN9200	IM9200
● Gray	IMN9201	IM9201
○ White	IMN9202	IM9202
● Orange	IMN9203	IM9203
● Purple	IMN9204	
● Yellow	IMN9205	IM9205
● Lavender	IMN9206	IM9206
● Black	IMN9207	
● Blue	IMN9208	IM9208
● Green	IMN9209	IM9209
● Ocean Blue	IMN92011	



Ultrasonic Insert/Handpiece Cassettes

Small Ultrasonic Insert/Handpiece Cassette holds 2 ultrasonic inserts or 1 handpiece while the Large Ultrasonic Insert/Handpiece Cassette holds up to 3 high-speed handpieces or 5 ultrasonic inserts. Both options feature silicone finger mats for protection of delicate items.



Small Ultrasonic Insert/Handpiece Cassette
 Small Ultrasonic Insert/Handpiece Cassette holds 2 ultrasonic inserts or 1 handpiece and features silicone finger mats for protection of delicate items.
 1.5" X 8" X 1.25" (38 mm x 203 mm x 32 mm)

	Infinity Series	Signature Series
● Red	IMN30HU0	IM30HU0
● Gray	IMN30HU1	IM30HU1
○ White	IMN30HU2	IM30HU2
● Orange	IMN30HU3	IM30HU3
● Purple	IMN30HU4	
● Yellow	IMN30HU5	IM30HU5
● Lavender	IMN30HU6	IM30HU6
● Black	IMN30HU7	
● Blue	IMN30HU8	IM30HU8
● Green	IMN30HU9	IM30HU9
● Ocean Blue	IMN30HU11	



Large Ultrasonic Insert/Handpiece Cassette
 The Large Ultrasonic Insert/Handpiece Cassette holds up to 3 high-speed handpieces or 5 ultrasonic inserts and features silicone finger mat for protection of delicate items.
 3" X 8" X 1.25" (76 mm x 203 mm x 32 mm)

	Infinity Series	Signature Series
● Red	IMN60HU0	IM60HU0
● Gray	IMN60HU1	IM60HU1
○ White	IMN60HU2	IM60HU2
● Orange	IMN60HU3	IM60HU3
● Purple	IMN60HU4	
● Yellow	IMN60HU5	IM60HU5
● Lavender	IMN60HU6	IM60HU6
● Black	IMN60HU7	
● Blue	IMN60HU8	IM60HU8
● Green	IMN60HU9	IM60HU9
● Ocean Blue	IMN60HU11	



Orthodontic Cassettes

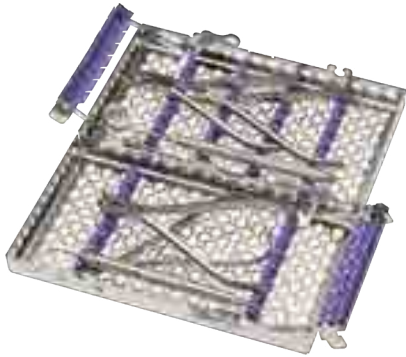

Double-Decker™ Small Orthodontic Cassette
 Holds up to 3 pliers, a Mathieu needle holder, and 2 hand instruments.
 Hinged instruments should be in open position.
 4.5" X 8" X 1.5" (114 mm x 203 mm x 38 mm)

	Infinity Series	Signature Series
● Red	IMN9140-O	IM9140-OR
● Gray	IMN9141-O	IM9141-OR
○ White	IMN9142-O	IM9142-OR
● Orange	IMN9143-O	IM9143-OR
● Purple	IMN9144-O	
● Yellow	IMN9145-O	IM9145-OR
● Lavender	IMN9146-O	IM9146-OR
● Black	IMN9147-O	
● Blue	IMN9148-O	IM9148-OR
● Green	IMN9149-O	IM9149-OR
● Ocean Blue	IMN91411-O	



Double-Decker™ Large Orthodontic Signature Series™ Cassette
 Holds up to 6 pliers, 1 Mathieu needle holder, and 3 hand instruments.
 No accessory area. Hinged instruments should be in open position.
 6" X 8" X 1.5" (152 mm x 203 mm x 38 mm)

● Red	IM5200-OR
● Gray	IM5201-OR
○ White	IM5202-OR
● Orange	IM5203-OR
● Yellow	IM5205-OR
● Lavender	IM5206-OR
● Blue	IM5208-OR
● Green	IM5209-OR



Small Thin Orthodontic Cassette

Holds up to 4 pliers and 3 hand instruments. Hinged instruments should be in open position.

7" X 8" X .75" (178 mm x 203 mm x 19 mm)

	Infinity Series	Signature Series
● Purple	IMNORTHS4	
● Blue	IMNORTHS8	IMORTHSM8
● Green	IMNORTHS9	

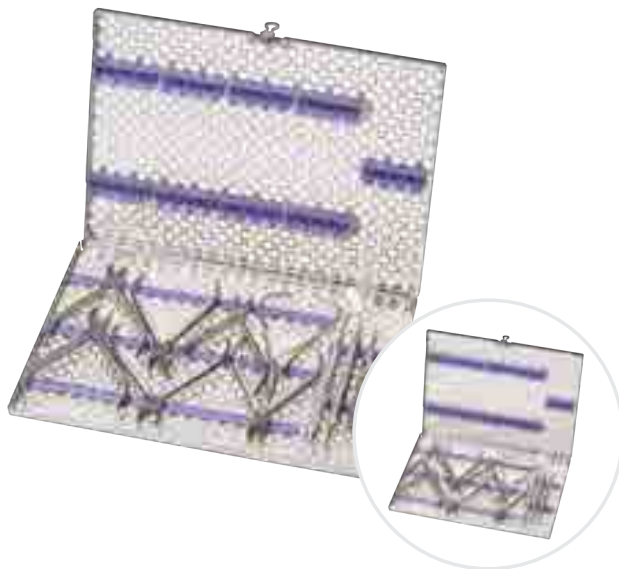

Large Thin Orthodontic Cassette

Holds up to 7 pliers and 4 hand instruments. Hinged instruments should be in open position.

8" X 11" X .75" (203 mm x 280 mm x 19 mm)

	Infinity Series	Signature Series
● Purple	IMNORTHL4	
● Blue	IMNORTHL8	IMORTHLG8
● Green	IMNORTHL9	



Piezo Handpiece Cassettes

Small Piezo Handpiece Cassette holds 1 Piezo Handpiece while the Large Piezo Handpiece Cassette holds 2 Piezo Handpieces.



Piezo Handpiece Cassette

	Single	Double
	1.5" X 8" X 1.25" (38 mm x 203 mm x 32 mm)	3" X 8" X 1.25" (76 mm x 203 mm x 32 mm)

● Blue	IM30IQ8	IM60IQ8
--------	----------------	----------------

Piezo Wrench Cassette

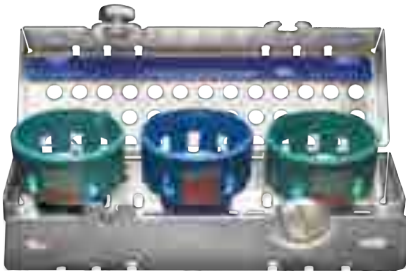

Piezo Wrench Cassette

Holds 3 Piezo Wrenches.
5.63" X 1.95" X 1.77" (143 mm x 50 mm x 45 mm)

● Blue	IMIQ38
--------	---------------

Radiography Cassette



Radiography Cassette

Radiography Cassette. Holds heat sterilizable x-ray accessories.

5.5" X 8" X 1.25" (140 mm x 203 mm x 32 mm)	IMN7000
---	----------------



Accessories & Organization Products

We offer many cassette accessories and organizational products available to support smaller items in a procedure as well as color-coding and tracking needs.



IMS™ Parts Box

Designed to keep small items such as mirror heads, rubber dam clamps and matrix band retainers organized during the sterilization process.

Large
3.5" X 1.12" X 1" (89 mm x 29 mm x 25 mm)

IMS-1273

Small
1.56" X 1.25" X 1" (40 mm x 32 mm x 25 mm)

IMS-1271

Barcode Plates

Metal plate can have barcode label affixed or can be lasermarked with text. Barcodes cannot be lasermarked onto the metal.



Signature Series™ Barcode Plate

.88" X 1.88" X .047" (22 mm x 48 mm x 1.2 mm)

IMS-1378



Infinity Series™ Barcode Plate

.88" X 1.75" X .047" (22 mm x 44 mm x 1.2 mm)

IMS-1379



IMS™ Endodontic Stand

Hinged, double-lid stand holds endodontic files and reamers. Lid is etched with a ruler to measure stop positions easily from either direction.

2.6" X 2.25" X 1.2" (67 mm x 57 mm x 30 mm)

Holds 24 **IMS-1275**

Holds 48 **IMS-1275D**

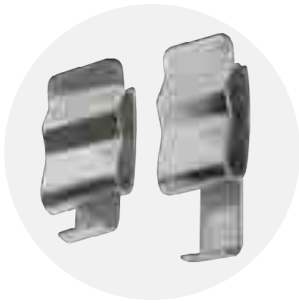

Air/Water Clip

Hold air/water syringe tips securely in place throughout cleaning and sterilization. Clips snap directly onto cassettes. Ask your rep for options to permanently install a/w clips to your cassettes.

For Infinity Series™ Cassette **IM1005N**

For Signature Series™ Cassette **IM1005**

For Infinity Series™ and Signature Series™ Double-Decker™ Cassette **IM1006**

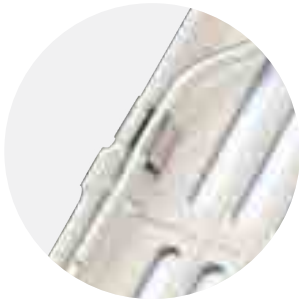

IMS™ Resin Cassette Clip

Large **IMS-1278**

Small **IMS-1279**

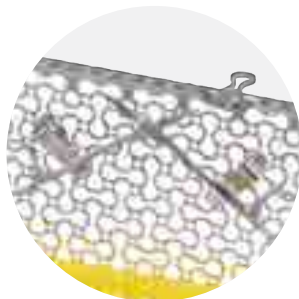

Hinged Instrument Clips

Secure scissors, hemostats, and other hinged instruments in the open position for optimal cleaning and sterilization with hinged instrument clips. Ask your rep for options to permanently install hinged instrument clips to your cassettes.

2 Pack **IM1000**

6 Pack **IM1002**



Needle Cap Holders

Needle cap holds attach to the cassette to help maintain the cap in upright position for one-handed needle recapping. Ask your rep for options to permanently install needle cap holders to your cassettes.

2 Pack **IM1001**

6 Pack **IM1003**

Combination Pack **IM1004**

Includes: 6 snap-in needle cap holders and 6 snap-in hinged instrument clips

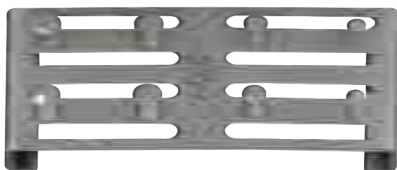

Rubber Dam Clamp Organizing Board

Rubber Dam Clamp Organizing Board. Holds up to 8 clamps during reprocessing. Fits into cassette accessory of most IMS™ Cassettes.

4.6" X 2.4" X .375" (117 mm x 61 mm x 10 mm) **RDCOB**

Bur Cushions

IMS™ Bur Cushions feature a hollow, rectangular, silicone base with a stainless steel lid designed to hold burs securely in place during cleaning and sterilization. Hollow design allows drainage and proper cleaning. Silicone base allows for different size burs. Please check bur manufacturer instructions for use to ensure ability to be reprocessed.



IMS™ 1/2 Bur Cushion, Short Lid

1.75" X 1.3" X .9" (44 mm x 33 mm x 22 mm) **IMS-1372SH**

IMS™ 1/2 Bur Cushion, Tall Lid

1.75" X 2.44" X .9" (44 mm x 62 mm x 22 mm) **IMS-1372TH**

IMS™ Bur Cushion, Short Lid

3.3" X 1.3" X .9" (84 mm x 33 mm x 22 mm) **IMS-1372S**

IMS™ Bur Cushion, Tall Lid

3.3" X 2.44" X .9" (84 mm x 62 mm x 22 mm) **IMS-1372T**



IMS™ Color Code Instrument Rings - Large

Silicone rings used for identifying and organizing instruments. Helpful for maintaining proper instrument order in cassettes or identifying by procedure or clinician. Large rings compatible with #6, #7, #8, and #9 handles. 50 per jar

● Gray	IMS-1281L
○ White	IMS-1282L
● Orange	IMS-1283L
● Brown	IMS-1284L
● Yellow	IMS-1285L
● Red	IMS-1286L
● Green	IMS-1287L
● Blue	IMS-1288L
● Black	IMS-1289L
● Pink	IMS-12810L
● Lavender	IMS-12811L
● Ocean Blue	IMS-12812L
● Purple	IMS-12813L
Assorted Colors (90 per jar)	IMS-1280L

IMS™ Color Code Instrument Rings - Small

Silicone rings used for identifying and organizing instruments. Helpful for maintaining proper instrument order in cassettes or identifying by procedure or clinician. Small rings compatible with #2 and #4 handles. 50 per jar

● Gray	IMS-1281
○ White	IMS-1282
● Orange	IMS-1283
● Brown	IMS-1284
● Yellow	IMS-1285
● Red	IMS-1286
● Green	IMS-1287
● Blue	IMS-1288
● Black	IMS-1289
● Pink	IMS-12810
● Lavender	IMS-12811
● Ocean Blue	IMS-12812
● Purple	IMS-12813
Assorted Colors (90 per jar)	IMS-1280



Cassette I.D. Labels and Marker

Specially designed polyester pressure-sensitive labels for cassette identification. Use the permanent indelible ink marker to write procedural specific information on I.D. labels or on Monitor Tape.

IMS™ Cassette I.D. Labels (50 per package)	IMS-1234
IMS™ I.D. Marker	IMS-1235



ResinEight™ Colors Grips (16)

Used with the #7, #8, #C8 and #9 handles

● Blue	SSGBLUE8
● Gray	SSGGRAY8
● Green	SSGGREEN8
● Lavender	SSGLAVNDR8
● Orange	SSGORANGE8
● Purple	SSGPURPLE8
● Red	SSGRED8
● Yellow	SSGYELLOW8

Grips

Grips are used to identify and organize instruments.

Signature Series Grips (80)

Used with the #7, #8, #C8 and #9 handles

Assorted	SSGMULTI
----------	-----------------

Signature Series Grips (16)

Used with the #7, #8, #C8 and #9 handles

● Gray	SSG1
● Pink	SSG10
● Lavender	SSG11
● Ocean Blue	SSG12
○ White	SSG2
● Orange	SSG3
● Brown	SSG4
● Yellow	SSG5
● Red	SSG6
● Green	SSG7
● Blue	SSG8
● Black	SSG9
Assorted	SSG0



IMS™ Color Tabs

Silicone color tabs fit on cassette lid for color-code identification by procedure or clinician.

5 per package

● Red	IMS-1290N
● Gray	IMS-1291N
○ White	IMS-1292N
● Orange	IMS-1293N
● Purple	IMS-1294N
● Yellow	IMS-1295N
● Lavender	IMS-1296N
● Black	IMS-1297N
● Blue	IMS-1298N
● Green	IMS-1299N
● Pink	IMS-12910N
● Ocean Blue	IMS-12911N
● Brown	IMS-12913N
Assorted Colors (13 per package)	IMS-12912N



Cassette Replacement Parts

There are times where instrument rails or other small cassette components need replaced after a long time of use. Replacement items are available to keep your cassettes looking like new.

Infinity Series™ Replacement Rail Packs

Replacement packs provide both the compression and instrument rails for your Infinity Series™ Cassettes. It is best to replace them all at the same time for consistency. To identify which pack you need, look at the lid of your Infinity Series™ Cassette. If you have two embossed stripes across the lid/infinity pattern, you need to order the replacement pack for the embossed lid.

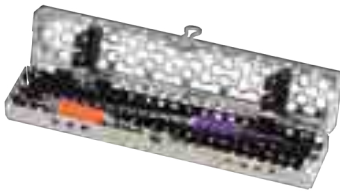

Infinity Series™ Small Handpiece Cassette - Rail Replacement Set

● Red	PK-30HU0RL
● Gray	PK-30HU1RL
○ White	PK-30HU2RL
● Orange	PK-30HU3RL
● Purple	PK-30HU4RL
● Yellow	PK-30HU5RL
● Lavender	PK-30HU6RL
● Black	PK-30HU7RL
● Blue	PK-30HU8RL
● Green	PK-30HU9RL
● Ocean Blue	PK-30HU11R



Plain Lid



Embossed lid

Infinity Series™ Large 12 Instrument Cassette - Rail Replacement Set

	Plain Lid	Embossed lid
● Red	PK-4120RL	PKE-4120R
● Gray	PK-4121RL	PKE-4121R
○ White	PK-4122RL	PKE-4122R
● Orange	PK-4123RL	PKE-4123R
● Purple	PK-4124RL	PKE-4124R
● Yellow	PK-4125RL	PKE-4125R
● Lavender	PK-4126RL	PKE-4126R
● Black	PK-4127RL	PKE-4127R
● Blue	PK-4128RL	PKE-4128R
● Green	PK-4129RL	PKE-4129R
● Ocean Blue	PK-41211RL	PKE-41211R



Plain Lid

Embossed lid

Infinity Series™ Large 16 Instrument Cassette - Rail Replacement Set

	Plain Lid	Embossed lid
● Red	PK-4160RL	PKE-4160R
● Gray	PK-4161RL	PKE-4161R
○ White	PK-4162RL	PKE-4162R
● Orange	PK-4163RL	PKE-4163R
● Purple	PK-4164RL	PKE-4164R
● Yellow	PK-4165RL	PKE-4165R
● Lavender	PK-4166RL	PKE-4166R
● Black	PK-4167RL	PKE-4167R
● Blue	PK-4168RL	PKE-4168R
● Green	PK-4169RL	PKE-4169R
● Ocean Blue	PK-41611RL	PKE-41611R



Plain Lid

Embossed lid

Infinity Series™ Large 20 Instrument Cassette - Rail Replacement Set

	Plain Lid	Embossed lid
● Red	PK-4200RL	PKE-4200R
● Gray	PK-4201RL	PKE-4201R
○ White	PK-4202RL	PKE-4202R
● Orange	PK-4203RL	PKE-4203R
● Purple	PK-4204RL	PKE-4204R
● Yellow	PK-4205RL	PKE-4205R
● Lavender	PK-4206RL	PKE-4206R
● Black	PK-4207RL	PKE-4207R
● Blue	PK-4208RL	PKE-4208R
● Green	PK-4209RL	PKE-4209R
● Ocean Blue	PK-42011RL	PKE-42011R

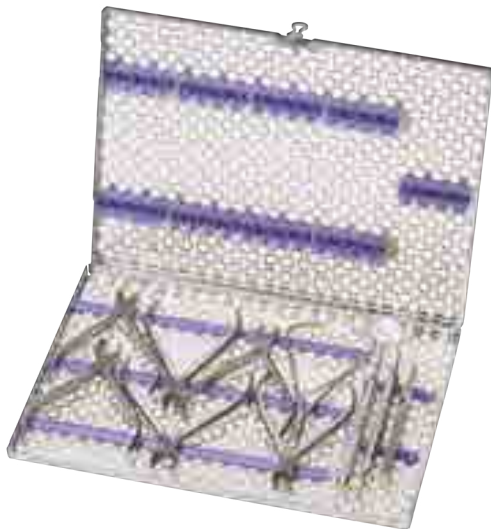

Infinity Series™ Large Thin Ortho Cassette - Rail Replacement Set

● Purple	PK-ORTL4L
● Blue	PK-ORTL8L
● Green	PK-ORTL9L



Infinity Series™ Small Thin Ortho Cassette - Rail Replacement Set

● Purple	PK2-ORTS4L
● Blue	PK2-ORTS8L
● Green	PK2-ORTS9L



Infinity Series™ Small 8 Instrument Cassette - Rail Replacement Set

● Red	PK2-5080RL
● Gray	PK2-5081RL
○ White	PK2-5082RL
● Orange	PK2-5083RL
● Purple	PK2-5084RL
● Yellow	PK2-5085RL
● Lavender	PK2-5086RL
● Black	PK2-5087RL
● Blue	PK2-5088RL
● Green	PK2-5089RL
● Ocean Blue	PK2-50811R

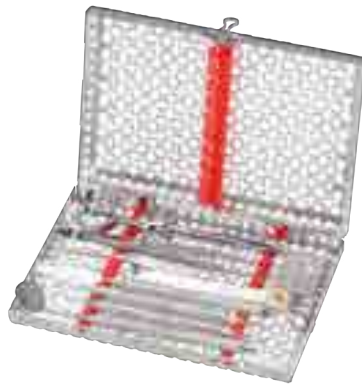

Infinity Series™ Small 10 Instrument Cassette - Rail Replacement Set

● Red	PK2-5100RL
● Gray	PK2-5101RL
○ White	PK2-5102RL
● Orange	PK2-5103RL
● Purple	PK2-5104RL
● Yellow	PK2-5105RL
● Lavender	PK2-5106RL
● Black	PK2-5107RL
● Blue	PK2-5108RL
● Green	PK2-5109RL
● Ocean Blue	PK2-51011R

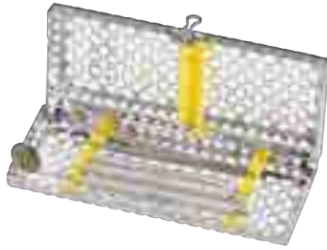

Infinity Series™ Exam Cassette - 5 Instrument - Rail Replacement Set

● Red	PK2-6050RL
● Gray	PK2-6051RL
○ White	PK2-6052RL
● Orange	PK2-6053RL
● Purple	PK2-6054RL
● Yellow	PK2-6055RL
● Lavender	PK2-6056RL
● Black	PK2-6057RL
● Blue	PK2-6058RL
● Green	PK2-6059RL
● Ocean Blue	PK2-60511R



Infinity Series™ Large Handpiece Cassette - Rail Replacement Set

● Red	PK-60H0RL
● Gray	PK-60H1RL
○ White	PK-60H2RL
● Orange	PK-60H3RL
● Purple	PK-60H4RL
● Yellow	PK-60H5RL
● Lavender	PK-60H6RL
● Black	PK-60H7RL
● Blue	PK-60H8RL
● Green	PK-60H9RL
● Ocean Blue	PK-60H11RL

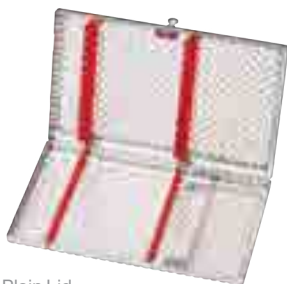

Plain Lid



Embossed lid

Infinity Series™ Signa Stat Cassette - 12 Instrument Rail Replacement Set

	Plain Lid	Embossed lid
● Red	PK-8120RL	PKE-8120R
● Gray	PK-8121RL	PKE-8121R
○ White	PK-8122RL	PKE-8122R
● Orange	PK-8123RL	PKE-8123R
● Purple	PK-8124RL	PKE-8124R
● Yellow	PK-8125RL	PKE-8125R
● Lavender	PK-8126RL	PKE-8126R
● Black	PK-8127RL	PKE-8127R
● Blue	PK-8128RL	PKE-8128R
● Green	PK-8129RL	PKE-8129R
● Ocean Blue	PK-81211RL	PKE-81211R



Infinity Series™ 8 Instrument Double-Decker™ Cassette - Rail Replacement Set

● Red	PK-9080RL
● Gray	PK-9081RL
○ White	PK-9082RL
● Orange	PK-9083RL
● Purple	PK-9084RL
● Yellow	PK-9085RL
● Lavender	PK-9086RL
● Black	PK-9087RL
● Blue	PK-9088RL
● Green	PK-9089RL
● Ocean Blue	PK-90811RL



Infinity Series™ 14 Instrument Double-Decker™ Cassette - Rail Replacement Set

● Red	PK-9140RL
● Gray	PK-9141RL
○ White	PK-9142RL
● Orange	PK-9143RL
● Purple	PK-9144RL
● Yellow	PK-9145RL
● Lavender	PK-9146RL
● Black	PK-9147RL
● Blue	PK-9148RL
● Green	PK-9149RL
● Ocean Blue	PK-91411RL

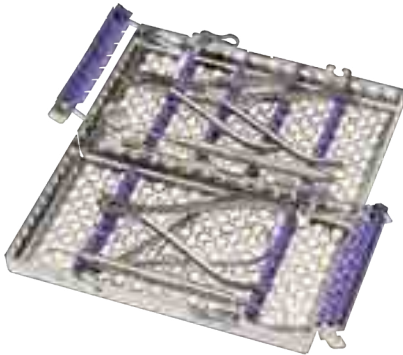

Infinity Series™ Double-Decker™ Small Orthodontic Cassette - Rail Replacement Set

● Red	PK-9140OR
● Gray	PK-9141OR
○ White	PK-9142OR
● Orange	PK-9143OR
● Purple	PK-9144OR
● Yellow	PK-9145OR
● Lavender	PK-9146OR
● Black	PK-9147OR
● Blue	PK-9148OR
● Green	PK-9149OR
● Ocean Blue	PK-91411OR



Infinity Series™ 20 Instrument Double-Decker™ Cassette - Rail Replacement Set
Embossed lid

● Red	PK-9200RL
● Gray	PK-9201RL
○ White	PK-9202RL
● Orange	PK-9203RL
● Purple	PK-9204RL
● Yellow	PK-9205RL
● Lavender	PK-9206RL
● Black	PK-9207RL
● Blue	PK-9208RL
● Green	PK-9209RL
● Ocean Blue	PK-92011RL

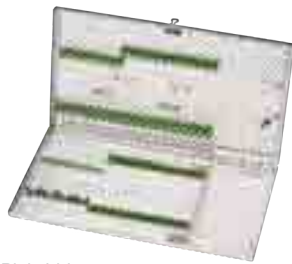

Plain Lid



Embossed lid

Infinity Series™ Oral Surgery Cassette - Rail Replacement Set

	Plain Lid	Embossed lid
● Red	PK-OS0RAIL	PKE-OS0R
● Gray	PK-OS1RAIL	PKE-OS1R
○ White	PK-OS2RAIL	PKE-OS2R
● Orange	PK-OS3RAIL	PKE-OS3R
● Purple	PK-OS4RAIL	PKE-OS4R
● Yellow	PK-OS5RAIL	PKE-OS5R
● Lavender	PK-OS6RAIL	PKE-OS6R
● Black	PK-OS7RAIL	PKE-OS7R
● Blue	PK-OS8RAIL	PKE-OS8R
● Green	PK-OS9RAIL	PKE-OS9R
● Ocean Blue	PK-OS11RAI	PKE-OS11R

Double Decker Replacement Arm

8 Instrument Double Decker Arm	PTI-0008
14 Instrument Double Decker Arm	PTI-0029
20 Instrument Double Decker Arm	PTI-0050

Signature Series™ Replacement Latches

Cassette Latch Kit	LT
10 Cassette Latch Kit	LRK

Infinity Series™ Replacement Latches

Cassette Latch Kit	LTN
10 Cassette Latch Kit	LRKN

IMS Cassette Tools

[LRKTOOLS](#)



Signature Series™ Replacement Rails & Packs

Replacement packs provide both the compression and instrument rails for your Signature Series™ Cassettes. It is best to replace them all at the same time for consistency.



Signature Series™ Small Handpiece Cassette - Rail Replacement Set

● Red	IM30HU0RL
● Gray	IM30HU1RL
○ White	IM30HU2RL
● Orange	IM30HU3RL
● Yellow	IM30HU5RL
● Lavender	IM30HU6RL
● Blue	IM30HU8RL
● Green	IM30HU9RL



Signature Series™ Small 8 Instrument Cassette - Rail Replacement Set

● Red	IM5080RAIL
● Gray	IM5081RAIL
○ White	IM5082RAIL
● Orange	IM5083RAIL
● Yellow	IM5085RAIL
● Lavender	IM5086RAIL
● Blue	IM5088RAIL
● Green	IM5089RAIL



Signature Series™ Small 10 Instrument Cassette - Rail Replacement Set

● Red	IM5100RAIL
● Gray	IM5101RAIL
○ White	IM5102RAIL
● Orange	IM5103RAIL
● Yellow	IM5105RAIL
● Lavender	IM5106RAIL
● Blue	IM5108RAIL
● Green	IM5109RAIL



Signature Series™ Large 16 Instrument Cassette - Rail Replacement Set

● Red	IM4160RAIL
● Gray	IM4161RAIL
○ White	IM4162RAIL
● Orange	IM4163RAIL
● Yellow	IM4165RAIL
● Lavender	IM4166RAIL
● Blue	IM4168RAIL
● Green	IM4169RAIL



Signature Series™ Large 20 Instrument Cassette - Rail Replacement Set

● Red	IM4200RAIL
● Gray	IM4201RAIL
○ White	IM4202RAIL
● Orange	IM4203RAIL
● Yellow	IM4205RAIL
● Lavender	IM4206RAIL
● Blue	IM4208RAIL
● Green	IM4209RAIL



Signature Series™ Large Double-Decker™ - Ortho Cassette - Rail Replacement Set

● Red	IM5200-ORR
● Gray	IM5201-ORR
○ White	IM5202-ORR
● Orange	IM5203-ORR
● Yellow	IM5205-ORR
● Lavender	IM5206-ORR
● Blue	IM5208-ORR
● Green	IM5209-ORR

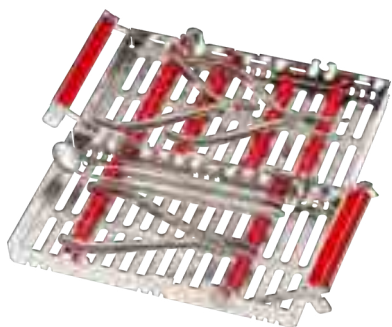

Signature Series™ Small Double-Decker™ - Ortho Cassette - Rail Replacement Set

● Red	IM9140ORL
● Gray	IM9141ORL
○ White	IM9142ORL
● Orange	IM9143ORL
● Yellow	IM9145ORL
● Lavender	IM9146ORL
● Blue	IM9148ORL
● Green	IM9149ORL

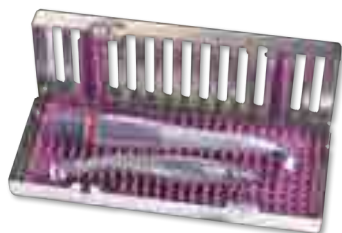

Signature Series™ Large Handpiece Cassette - Rail Replacement Set

● Red	IM60H0RAIL
● Gray	IM60H1RAIL
○ White	IM60H2RAIL
● Orange	IM60H3RAIL
● Yellow	IM60H5RAIL
● Lavender	IM60H6RAIL
● Blue	IM60H8RAIL
● Green	IM60H9RAIL



Signature Series™ Exam Cassette - 5 Instrument - Rail Replacement Set

● Red	IM6050RAIL
● Gray	IM6051RAIL
○ White	IM6052RAIL
● Orange	IM6053RAIL
● Yellow	IM6055RAIL
● Lavender	IM6056RAIL
● Blue	IM6058RAIL
● Green	IM6059RAIL



Signature Series™ 8 Instrument Double-Decker™ Cassette - Rail Replacement Set

● Red	IM9080RAIL
● Gray	IM9081RAIL
○ White	IM9082RAIL
● Orange	IM9083RAIL
● Yellow	IM9085RAIL
● Lavender	IM9086RAIL
● Blue	IM9088RAIL
● Green	IM9089RAIL



Signature Series™ 14 Instrument Double-Decker™ Cassette - Rail Replacement Set

● Red	IM9140RAIL
● Gray	IM9141RAIL
○ White	IM9142RAIL
● Orange	IM9143RAIL
● Yellow	IM9145RAIL
● Lavender	IM9146RAIL
● Blue	IM9148RAIL
● Green	IM9149RAIL

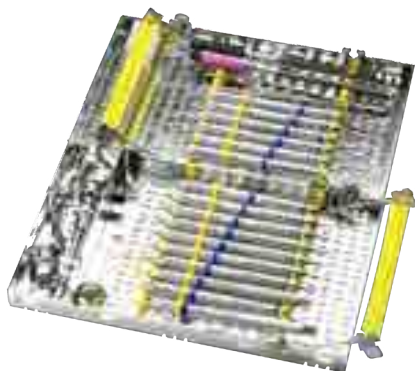

Signature Series™ 20 Instrument Double-Decker™ Cassette - Rail Replacement Set

● Red	IM9200RAIL
● Gray	IM9201RAIL
○ White	IM9202RAIL
● Orange	IM9203RAIL
● Yellow	IM9205RAIL
● Lavender	IM9206RAIL
● Blue	IM9208RAIL
● Green	IM9209RAIL



Signature Series™ Signa Stat Cassette - 12 Instrument - Rail Replacement Set

● Red	IM8120RAIL
● Gray	IM8121RAIL
○ White	IM8122RAIL
● Orange	IM8123RAIL
● Yellow	IM8125RAIL
● Lavender	IM8126RAIL
● Blue	IM8128RAIL
● Green	IM8129RAIL



Signature Series™ Oral Surgery Cassette - Rail Replacement Set

● Red	IMOS0RAIL
● Gray	IMOS1RAIL
○ White	IMOS2RAIL
● Orange	IMOS3RAIL
● Yellow	IMOS5RAIL
● Lavender	IMOS6RAIL
● Blue	IMOS8RAIL
● Green	IMOS9RAIL

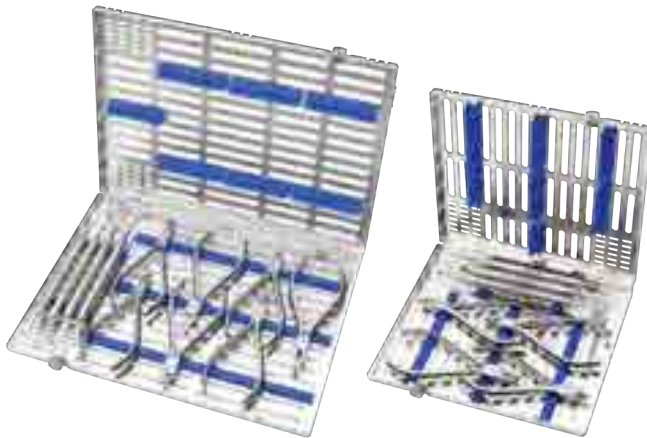

Signature Series™ Thin Ortho Cassette - Rail Replacement Set

● Blue (Small)	IMORTS8RL
● Blue (Large)	IMORTL8RL

Space Saver Seven Replacement Rail Set

Replacement packs provide both the compression and instrument rails for your Space Saver Seven Cassettes. It is best to replace them all at the same time for consistency.



Signature Series™ Space Saver Seven Cassette - Rail Replacement Set

● Red	IMSS70RAIL
● Gray	IMSS71RAIL
○ White	IMSS72RAIL
● Orange	IMSS73RAIL
● Yellow	IMSS75RAIL
● Lavender	IMSS76RAIL
● Blue	IMSS78RAIL
● Green	IMSS79RAIL



Procedural Kits

The IMS™ Collection Series Kits feature a compilation of the most popular procedural set-ups. One part code for a full procedure consisting of a cassette and instruments is provided at a reduced price vs a la carte ordering. An ideal solution for recent dental graduates.



Learn more about our [Procedural Kits](#).



Exam Standard Set-Up 3" x 8" x 1.25" (76 mm x 203 mm x 32 mm)	Infinity Series™ Set-Up	Signature Series™ Set-Up
	IMNEXAM	IMEXAM
Exam Cassette - 5 Instrument, Yellow	IMN6055	IM6055
#5 Front Surface Rhodium Single- Sided Mirror (qty: 3)	MIR5/3	MIR5/3
#6 Cone Socket Mirror Handle	MH6	MH6
Quix SE Probe, 3-6-9-12, #6 Handle	PCP126	PCP126
#5 DE Explorer, #6 Handle	EXD56	EXD56
Dressing Pliers, Utility Pick-Up	DPU17	DPU17



	Total Restorative Standard Set-Up (Composite, Crown & Bridge, Amalgam) 8" x 11" x 1.25" (203 mm x 280 mm x 32 mm)	
	Infinity Series™ Set-Up IMNRESTOR	Signature Series™ Set-Up IMRESTOR
Large 16 Instrument Cassette, Yellow	IMN4165	IM4165
#6 Cone Socket Mirror Handle	MH6	MH6
#5 Front Surface Rhodium Single-Sided Mirror (qty: 3)	MIR5/3	MIR5/3
#23/CP-12 Expro, #6 Handle	XP23/126	XP23/126
18 Excavator, #6 Handle	EXC186	EXC186
113 Gingival Cord Packer, Serrated, #6 Handle	GCP1136	GCP1136
Calcium Hydroxide Placer, #6 Handle	PICH6	PICH6
0/1 Serrated Marquette Condenser, #6 Handle	PLG0/16	PLG0/16
1/2 Serrated Plugger, #6 Handle	PLG1/26	PLG1/26
3/6 Carver, #6 Handle	CD3/66	CD3/66
8 Wiland, #6 Handle	CVWI86	CVWI86
1/2 Hollenback, #6 Handle	CVHL1/26	CVHL1/26
Interproximal Carver, XTS™ Handle	TNCVIPC	TNCVIPC
Goldstein Flexi-Thin #2, XTS™ Handle	TNCIGFT2	TNCIGFT2
Goldstein Flexi-Thin, Extra-Flex #3, XTS™ Handle	TNCIGFT3	TNCIGFT3
27/29 Burnisher, #6 Handle	BB27/296	BB27/296
24 Flexible Spatula, #6 Handle	CS246	CS246
#2 Dressing Pliers (College)	DP2	DP2
Miller Articulating Paper Forceps	APF2	APF2
18 Iris Scissors, Curved	S18	S18
Cook-Waite Anesthetic Aspirating Syringe	SYRCW	SYRCW
IMS™ Bur Cushion, Short Lid	IMS-1372S	IMS-1372S
Hinged Instrument Clips, 2 Pack	IM1000	IM1000
Air/Water Clip	IM1005N	IM1005



Prophy Standard Set-Up

5.5" x 8" x 1.25" (140 mm x 203 mm x 32 mm)

	Infinity Series™ Set-Up	Signature Series™ Set-Up
	IMNPROPHY	IMPROPHY
10 Instrument Cassette, Lavender	IMN5106	IM5106
#6 Cone Socket Mirror Handle	MH6	MH6
#5 Front Surface Rhodium Single- Sided Mirror (QTY: 3)	MIR5/3	MIR5/3
Quix SE Probe, 3-6-9-12, #6 Handle	PCP126	PCP126
#11/12 ODU DE Explorer, #6 Handle	EXD11/126	EXD11/126
H6/7 Sickle Scaler, #9 Handle	SH6/79E2	SH6/79E2
Gracey 11/12 Standard Curette, #9 Handle	SG11/129E2	SG11/129E2
Gracey 13/14 Standard Curette, #9 Handle	SG13/149E2	SG13/149E2
Columbia 13/14 Standard Curette, #9 Handle	SC13/149E2	SC13/149E2
#3 Ceramic Stone	SS3C	SS3C
Air/Water Clip	IM1005N	IM1005



	Infinity Series™ Set-Up	Signature Series™ Set-Up
	IMNPERIO	IMPERIO
Perio Standard Set-Up 4.5" x 8" x 1.5" (114 mm x 203 mm x 38 mm)		
Double-Decker™ Cassette - 14 Instrument, Blue	IMN9148	IM9148
#6 Cone Socket Mirror Handle	MH6	MH6
#5 Front Surface Rhodium Single- Sided Mirror (qty: 3)	MIR5/3	MIR5/3
Quilix SE Probe, 3-6-9-12, #6 Handle	PCP126	PCP126
#11/12 ODU After Five DE Explorer, #6 Handle	EXD11/12A6	EXD11/12A6
H6/7 Sickle Scaler, #9 Handle	SH6/79E2	SH6/79E2
204S Posterior Sickle Scaler, #9 Handle	S204S9E2	S204S9E2
Gracey 1/2 Mini Five™ Curette, #9 Handle	SAS1/29E2	SAS1/29E2
Gracey 7/8 After Five™ Curette, #9 Handle	SRPG7/89E2	SRPG7/89E2
Gracey 11/12 After Five™ Curette, #9 Handle	SRPG11/129E2	SRPG11/129E2
Gracey 13/14 After Five™ Curette, #9 Handle	SRPG13/149E2	SRPG13/149E2
Columbia 4R/4L Curette, #9 Handle	SC4R/4L9E2	SC4R/4L9E2
#3 Ceramic Stone	SS3C	SS3C
Air/Water Clip	IM1006	IM1006



Composite/Crown Prep Standard Set-Up

8" x 11" x 1.25" (203 mm x 280 mm x 32 mm)

	Infinity Series™ Set-Up	Signature Series™ Set-Up
	IMNCMPOSIT	IMCOMPOSIT
16 Instrument Cassette, Blue	IMN4168	IM4168
#6 Cone Socket Mirror Handle	MH6	MH6
#5 Front Surface Rhodium Single- Sided Mirror (qty: 3)	MIR5/3	MIR5/3
#5 DE Explorer, #6 Handle	EXD56	EXD56
#18 DE Excavator, #6 Handle	EXC186	EXC186
#113 Gingival Cord Packer, Serrated, #6 Handle	GCP1136	GCP1136
Interproximal Carver, XTS™ Handle	TNCVIPC	TNCVIPC
Goldstein Flexi-Thin #2, XTS™ Handle	TNCIGFT2	TNCIGFT2
Goldstein Flexi-Thin, Extra-Flex #3, XTS™ Handle	TNCIGFT3	TNCIGFT3
24 Flexible Spatula, #6 Handle	CS246	CS246
#2 Dressing Pliers (College)	DP2	DP2
Miller Articulating Paper Forceps	APF2	APF2
Cook-Waite Anesthetic Aspirating Syringe	SYRCW	SYRCW
18 Iris Scissors, Curved	S18	S18
IMS™ Bur Cushion, Short Lid	IMS-1372S	IMS-1372S
Hinged Instrument Clips, 2 Pack	IM1000	IM1000
Air/Water Clip	IM1005N	IM1005



Endo Standard Set-Up 8" x 11" x 1.25" (203 mm x 280 mm x 32 mm)	Infinity Series™ Set-Up	Signature Series™ Set-Up
	IMNENDO	IMENDO
Large Cassette - 12 Instrument, Gray	IMN4121	IM4121
#6 Cone Socket Mirror Handle	MH6	MH6
#4 Front Surface Rhodium Single-Sided Mirror, Cone Socket (qty: 3)	MIR4/3	MIR4/3
DG16 DE Endo Explorer, #6 Handle	EXDG166	EXDG166
1 Endo Locking Pliers	EPL1	EPL1
31L DE Endo Excavator, #6 Handle	EXC31L6	EXC31L6
D11NT SE Root Canal Spreader	RCSD11NT	RCSD11NT
1/3 DE Root Canal Plugger	RCP1/3	RCP1/3
5/7 DE Root Canal Plugger	RCP5/7	RCP5/7
9/11 DE Root Canal Plugger	RCP9/11	RCP9/11
1 DE Glick Plastic Plugger	RCPGL1	RCPGL1
Miller Articulating Paper Forceps	APF2	APF2
Cook-Waite Anesthetic Aspirating Syringe	SYRCW	SYRCW
Rubber Dam Forceps #4	RDF	RDF
Rubber Dam Clamp #1	RDCM1	RDCM1
Rubber Dam Clamp #2	RCDM2	RCDM2
Rubber Dam Clamp #9	RDCM9	RDCM9
Rubber Dam Clamp #26N	RDCM26N	RDCM26N
IMS Endodontic Stand - Holds 24	IMS-1275	IMS-1275
IMS Small Parts Box	IMS-1271	IMS-1271
IMS Bur Cushion, Short Lid	IMS-1372S	IMS-1372S
Air/Water Clip	IM1005N	IM1005



Suture Removal Standard Set-Up

5.5" x 8" x 1.25" (140 mm x 203 mm x 32 mm)

	Infinity Series™ Set-Up	Signature Series™ Set-Up
	IMNSUTURE	IMSUTURE
Small Cassette - 10 Instrument, Orange	IMN5103	IM5103
#6 Cone Socket Mirror Handle	MH6	MH6
#5 Front Surface Rhodium Single-Sided Mirror (qty: 3)	MIR5/3	MIR5/3
#5 DE Explorer, #6 Handle	EXD56	EXD56
#13S Suture Scissors	S13S	S13S
2 College Dressing Pliers	DP2	DP2
Air/Water Clip	IM1005N	IM1005
Hinged Instrument Clips, 2 Pack	IM1000	IM1000
13/14 Columbia Curette, EE2 #9 Handle	SC13/149E2	SC13/149E2



Cement (Crown Seat) Standard Set-Up

5.5" x 8" x 1.25" (140 mm x 203 mm x 32 mm)

	Infinity Series™ Set-Up	Signature Series™ Set-Up
	IMNCEMENT	IMCEMENT
Small Cassette - 10 Instrument, Red	IMN5100	IM5100
#6 Cone Socket Mirror Handle	MH6	MH6
#5 Front Surface Rhodium Single-Sided Mirror (qty: 3)	MIR5/3	MIR5/3
#5 DE Explorer, #6 Handle	EXD56	EXD56
8 Wiland, #6 Handle	CVW186	CVW186
24 Flexible Spatula, #6 Handle	CS246	CS246
Miller Articulating Paper Forceps	APF2	APF2
Cook-Waite Anesthetic Aspirating Syringe	SYRCW	SYRCW
2 College Dressing Pliers	DP2	DP2
IMS™ 1/2 Bur Cushion, Short Lid	IMS-1372SH	IMS-1372SH
Air/Water Clip	IM1005N	IM1005



Crown & Bridge Standard Set-Up 8" x 11" x 1.25" (203 mm x 280 mm x 32 mm)	Infinity Series™ Set-Up	Signature Series™ Set-Up
	IMNCROWN	IMCROWN
Large Cassette With Accessory Area - 12 Instrument, Green	IMN4169	IM4169
#6 Cone Socket Mirror Handle	MH6	MH6
#5 Front Surface Rhodium Single-Sided Mirror (qty: 3)	MIR5/3	MIR5/3
#5 DE Explorer, #6 Handle	EXD56	EXD56
Quilix SE Probe, 3-6-9-12, #6 Handle	PCP126	PCP126
8 Wiland, #6 Handle	CVW186	CVW186
18 Excavator, #6 Handle	EXC186	EXC186
113 Gingival Cord Packer, Serrated, #6 Handle	GCP1136	GCP1136
Goldstein Flexi-Thin #2, XTS™ Handle	TNCIGFT2	TNCIGFT2
24 Flexible Spatula, #6 Handle	CS246	CS246
2 College Dressing Pliers	DP2	DP2
Miller Articulating Paper Forceps	APF2	APF2
Cook-Waite Anesthetic Aspirating Syringe	SYRCW	SYRCW
18 Iris Scissors, Curved	S18	S18
IMS Bur Cushion, Short Lid	IMS-1372S	IMS-1372S
Hinged Instrument Clips, 2 Pack	IM1000	IM1000
Air/Water Clip	IM1005N	IM1005



Amalgam Standard Set-Up

8" x 11" x 1.25" (203 mm x 280 mm x 32 mm)

	Infinity Series™ Set-Up	Signature Series™ Set-Up
	IMNAMALGAM	IMAMALGAM
Large Cassette With Accessory Area - 12 Instrument, White	IMN4162	IM4162
#6 Cone Socket Mirror Handle	MH6	MH6
#5 Front Surface Rhodium Single-Sided Mirror (qty: 3)	MIR5/3	MIR5/3
#5 DE Explorer, #6 Handle	EXD56	EXD56
18 Excavator, #6 Handle	EXC186	EXC186
Calcium Hydroxide Placer, #6 Handle	PICH6	PICH6
0/1 Serrated Marquette Condenser, #6 Handle	PLG0/16	PLG0/16
1/2 Serrated Plugger, #6 Handle	PLG1/26	PLG1/26
3/6 Carver, #6 Handle	CD3/66	CD3/66
89/92 Carver, #6 Handle	CD89/926	CD89/926
1/2 Hollenback, #6 Handle	CVHL1/26	CVHL1/26
21B Burnisher, #6 Handle	BB21B6	BB21B6
27/29 Burnisher, #6 Handle	BB27/296	BB27/296
2 College Dressing Pliers	DP2	DP2
Miller Articulating Paper Forceps	APF2	APF2
Cook-Waite Anesthetic Aspirating Syringe	SYRCW	SYRCW
IMS Bur Cushion, Short Lid	IMS-1372S	IMS-1372S
Air/Water Clip	IM1005N	IM1005



Sinus Lift Standard Set-Up 8" x 11" x 1.25" (203 mm x 280 mm x 32 mm)	Infinity Series™ Set-Up	Signature Series™ Set-Up
	IMNSINUS	IMSINUS
Large Cassette - 12 Instrument, Gray	IMN4121	IM4121
Hinged Instrument Clips, 2 Pack	IM1000	IM1000
Buser Periosteal, #6 Handle	PPBUSER6	PPBUSER6
Palti Bone Graft Scoop	IMP6522	IMP6522
Bone Rasp	RASP	RASP
Sinus Retractor Misch 10	SRM10	SRM10
1 Sinus Curette	SINC1	SINC1
2 Sinus Curette	SINC2	SINC2
Bone Grafting Syringe	SYBG	SYBG
#1 Mead Immunity Mallet	MAL1	MAL1
Crile-Wood Perma Sharp® Needle Holder	NH5038	NH5038
2/4 Molt DE Curette	CM2/4	CM2/4
#UNC12 Colorvue™ Probe Kit (1-2-3-4-5- 6-7-8-9-10-11-12)	PCVNCKIT6	PCVNCKIT6
23 Seldin Periosteal Retractor	P23	P23
Bone Packer DE	BPACK	BPACK

Instrument Management



Ortho Banding/Bonding Standard Set-Up **IMORTHOBB**
8" x 11" x 1.25" (203 mm x 280 mm x 32 mm)

Double-Decker™ Large Orthodontic Cassette, Orange	IM5203-OR
#6 Cone Socket Mirror Handle	MH6
#5 Front Surface Rhodium Single-Sided Mirror (qty: 3)	MIR5/3
Ligature Director/Band Pusher	678-912
1/2 Hollenback, #6 Handle	CVHL1/26
#18 Dressing Pliers	DP18
Universal Cut & Hold Distal End Cutter, Long Handle	678-101L
Micro Mini Pin & Ligature Cutter	678-107
Weingart Pliers, Long Handle	678-201L
Direct Bond Bracket Holder	678-212
Mathieu Pliers	678-330

Available in Signature Series only



Ortho Archwire Adjustment Standard Set-Up **IMORTHOAA**
6" x 8" x 1.5" (152 mm x 203 mm x 38 mm)

Double-Decker™ Large Orthodontic Cassette, Green	IM5209-OR
#6 Cone Socket Mirror Handle	MH6
#5 Front Surface Rhodium Single-Sided Mirror (qty: 3)	MIR5/3
Ligature Director/Scaler	678-905
Universal Cut & Hold Distal End Cutter, Long Handle	678-101L
Hard Wire Cutter, 15°	678-103
Micro Mini Pin & Ligature Cutter	678-107
Weingart Pliers, Long Handle	678-201L
Direct Bond Bracket Holder	678-212
Bird Beak Pliers	678-304
Three Jaw Pliers	678-302
Mathieu Pliers	678-330

Available in Signature Series only



Basic Extraction Standard Set-Up	IMEXTRACTB
8" x 11" x 1.25" (203 mm x 280 mm x 32 mm)	
Special Large Signature Series 16 Instrument Cassette, 2 Elevator Rails, 4 Posted Hinged Instrument Clips, Orange	IM4163E2C4
Posted Hinged Instrument Clips (2 packs of 2)	I1000
Cone Socket Mirror Handle, Satin Steel Handle	MH6
4 Front Surface Cone Socket Mirror, Single	MIR4
5 Round Scalpel Handle	10-130-05
9 Molt Periosteal Elevator, Satin Steel Handle	P96
13/14 Heidbrink DE Root Pick, Satin Steel Handle	EHB13/146
86 Lucas Surgical Curette, Satin Steel Handle	CL866
1X Miller-Colburn Bone File	BF1X6
2 Dressing Pliers (college)	DP2
Retractor U of Minnesota	CRM
Crile-Wood Needle Holder	NHCW
34 Seldin Elevator	E34S
301 Apexo Elevator	E301
42 Adson 1/X Tissue Pliers	TP42
Anesthetic Syringe Cook-Waite	SYRCW
1 Kelly Scissor, Curved	S1
Child Mouth Prop (1 pack of 2)	MP52

Available in Signature Series only



Full Extraction Standard Set-Up 8" x 14.5" x 1.25" (203 mm x 368 mm x 32 mm)	IMEXTRACTF
Special Signature Series Oral Surgery Cassette, 2 Elevator Rails, 4 Posted Hinged Instrument Clips, 6 Low Profile Rails, Lavender	IMOS6E2C4L
Posted Hinged Instrument Clips (2 packs of 2)	I1000
Cone Socket Mirror Handle, Satin Steel Handle	MH6
4 Front Surface Cone Socket Mirror, Single	MIR4
5 Round Scalpel Handle	10-30-05
9 Molt Periosteal Elevator, Satin Steel Handle	P96
13/14 Heidbrink DE Root Pick, Satin Steel Handle	EHB13/146
86 Lucas Surgical Curette, Satin Steel Handle	CL866
2/4 Molt DE Curette, Satin Steel Handle	CM2/46
1X Miller-Colburn Bone File	BF1X6
2 Dressing Pliers (college)	DP2
Retractor U of Minnesota	CRM
Crile-Wood Perma Sharp Needle Holder	NHCW
34S Seldin Elevator	E34S
E301 Apexo Elevator	E301
42 Adson 1/X Tissue Pliers	TP42
Anesethetic Syringe Cook-Waite	SYRCW
1 Kelly Scissor, Curved	S1
Child Mouth Prop (1 pack of 2)	MP52
150 Cryer Forceps	F150
151 Cryer Forceps	F151

Available in Signature Series only



ADA CDT Coding Collection Series

We have created a collection of procedural instrument kits that follow American Dental Association (ADA) — Current Dental Terminology (CDT) Coding. Start pairing patients and insurance codes more effectively to move from standardized care to personalized care. Each kit, uniquely color-coded, offers the highest quality, technology, and ergonomic instrumentation within a small, space-efficient cassette for ensured equipment compatibility and safety.



Evaluation Kit	IM-D0120/80
3" x 8" x 1.25" (76 mm x 203 mm x 32 mm)	
Exam Cassette - 5 Instrument, Blue	IM6058
#6 Cone Socket Mirror Handle	MH6
#5 HD Double-Sided Mirror	MIR5DSHD
Quilix SE UNC Probe, 1-12, #6 Handle	PCPUNC126
#5 DE Explorer, #6 Handle	EXD56
#11/12 ODU After Five DE Explorer, #6 Handle	EXD11/12A6
#2 Color Coded Nabers DE Probe 3-6-9-12, #6 Handle	PQ2N6

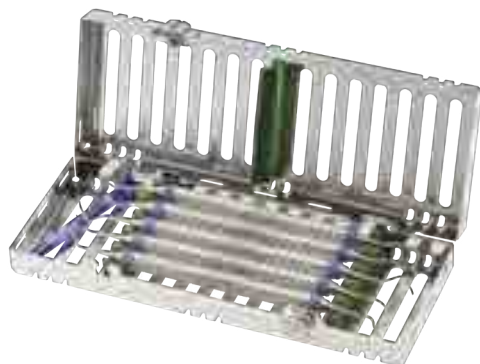

Prophylaxis Kit	IM-D1110
3" x 8" x 1.25" (76 mm x 203 mm x 32 mm)	
Exam Cassette - 5 Instrument, Green	IM6059
Plastic Test Stick	PTS-IND
Nevi™ 2 Posterior Sickle Scaler, #9 Handle	SCNEVI29E2
Nevi™ 4 Posterior Sickle Scaler, #9 Handle	SCNEVI49E2
Barnhart 5/6 Curette, #9 Handle	SBH5/69E2
Gracey 15/16 Curette, #9 Handle	SG15/169E2
Gracey 13/14 Standard Curette, #9 Handle	SG13/149E2

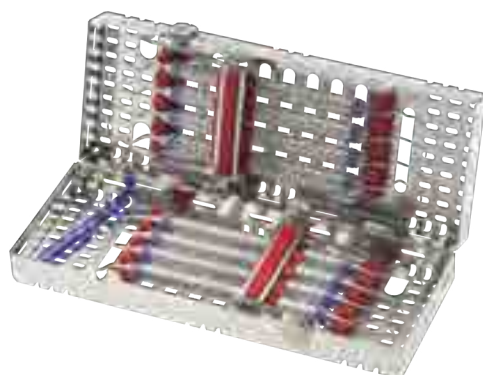

Scaling And Root Planing Kit	IM-D4341/42
3" x 8" x 1.5" (76 mm x 203 mm x 38 mm)	
Double-Decker™ Cassette - 8 Instrument, Red	IM9080
Plastic Test Stick	PTS-IND
Langer 3/4 After Five™ Curette, #9 Handle	SL3/4AF9E2
Nevi™ 2 Posterior Sickle Scaler, #9 Handle	SCNEVI29E2
Nevi™ 4 Posterior Sickle Scaler, #9 Handle	SCNEVI49E2
Gracey 1/2 Mini Five™ Curette, #9 Handle	SAS1/29E2
Gracey 7/8 After Five™ Curette, #9 Handle	SRPG7/89E2
Gracey 15/16 After Five™ Curette, #9 Handle	SRPG15/169E2
Gracey 13/14 After Five™ Curette, #9 Handle	SRPG13/149E2
Gracey 17/18 Curette, #9 Handle	SG17/189E2

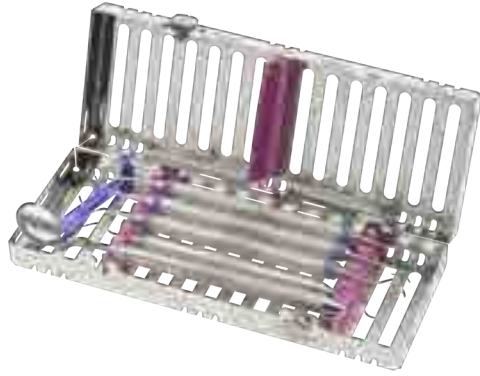

Pedo Propy Kit 3" x 8" x 1.25" (76 mm x 203 mm x 32 mm)	IM-D1120
Exam Cassette - 5 Instrument, Lavender	IM6056
#6 Cone Socket Mirror Handle	MH6
#5 HD Double-Sided Mirror	MIR5DSHD
#5 DE Explorer, #6 Handle	EXD56
Gracey 13/14 Standard Curette, #9 Handle	SC13/149E2
Nevi™ 3 Posterior Sickle Scaler, #9 Handle	SCNEVI39E2
Nevi™ 1 Anterior Sickle Scaler, #9 Handle	SCNEVI19E2
Plastic Test Stick	PTS-IND

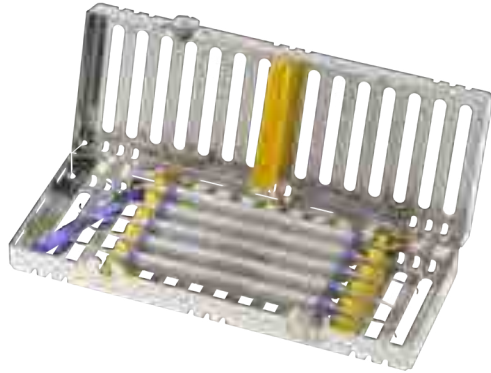

Presence Of Gingival Inflammation Kit 3" x 8" x 1.25" (76 mm x 203 mm x 32 mm)	IM-D4346
Exam Cassette - 5 Instrument, Yellow	IM6055
Plastic Test Stick	PTS-IND
Nevi™ 3 Posterior Sickle Scaler, #9 Handle	SCNEVI39E2
Nevi™ 4 Posterior Sickle Scaler, #9 Handle	SCNEVI49E2
Gracey 1/2 Mini Five™ Curette, #9 Handle	SAS1/29E2
Gracey 15/16 After Five™ Curette, #9 Handle	SRPG15/169E2
Gracey 13/14 After Five™ Curette, #9 Handle	SRPG13/149E2

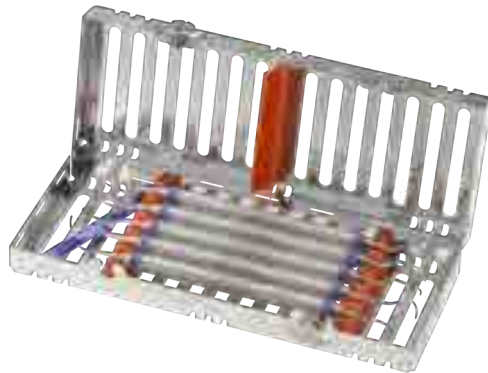

Debridement For Comprehensive Evaluation Kit 3" x 8" x 1.25" (76 mm x 203 mm x 32 mm)	IM-D4355
Exam Cassette - 5 Instrument, Orange	IM6053
Plastic Test Stick	PTS-IND
Nevi™ 4 Posterior Sickle Scaler, #9 Handle	SCNEVI4E92
McCall 17/18 Curette, #9 Handle	SM17/189E2
Gracey 1/2 Mini Five™ Curette, #9 Handle	SAS1/2R9E2
Gracey 15/16 After Five™ Curette, #9 Handle	SRP15/16R9E2
Gracey 13/14 After Five™ Curette, #9 Handle	SRP13/14R9E2

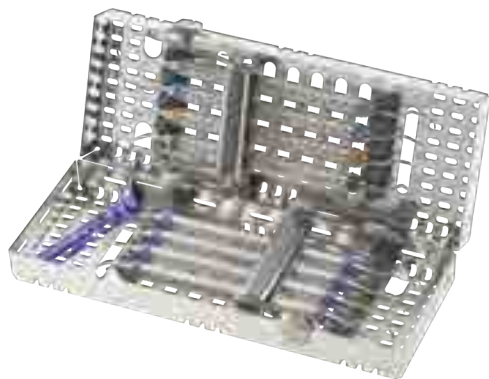

Periodontal Maintenance Kit	IM-D4910
3" x 8" x 1.5" (76 mm x 203 mm x 38 mm)	
Double-Decker™ Cassette - 8 Instrument, Gray	IM9081
Plastic Test Stick	PTS-IND
Langer 3/4 Curette, #9 Handle	SL3/49E2
Nevi™ 2 Posterior Sickle Scaler, #9 Handle	SCNEVI29E2
Nevi™ 4 Posterior Sickle Scaler, #9 Handle	SCNEVI49E2
Gracey 15/16 Curette, #9 Handle	SG15/169E2
Pattison Gracey Lite 1/2 Curette, #9 Handle, Gray	SG1/29APE2
Pattison Gracey Lite 7/8 Curette, #9 Handle, Green	SG7/89APE2
Pattison Gracey Lite 11/12 Curette, #9 Handle, Orange	SG11/129APE2
Pattison Gracey Lite 13/14 Curette, #9 Handle, Blue	SG13/149APE2



Implant Maintenance Kit	IM-D6080
3" x 8" x 1.25" (76 mm x 203 mm x 32 mm)	
Exam Cassette - 5 Instrument, White	IM6052
Colorvue™ Probe Kit 12 University of North Carolina	PCVPROMNC
Titanium Implant Scaler 204SD	IMP204SDT
Titanium Implant Scaler Langer 1/2	IMPLG1/2T
Titanium Implant Scaler Mini Five™ 1/2	IMPM1/2T
Implacare™ II H6/7 Scaler	IMPLH6/76
Plastic Test Stick	PTS-IND



Procedural Tubs

Together, procedure tubs and cassettes are an efficient and organized system for managing instruments and disposables by procedure. The time savings achieved by using IMS™ Cassettes and procedural tubs allows staff to spend more time on value added activities in the facility. Tub colors are designed to match the IMS™ Cassette rail colors and are treated with Sanafor® P0-5 antimicrobial* to protect the product by helping prevent the growth of stain and odor causing bacteria.

Organizational Tubs

Organizational tubs are available as complete tubs with accessories or can be ordered separately. Tubs available in 11 colors to match IMS™ Cassette rail colors.



Signature Series™ Complete Tub

Each Tub includes: Tub Liner, Dividers, Single Tub Cup With Cover, Double Tub Cup With Cover, Divided Slide Tray, Locking Tub Cover
12-3/4" X 11-3/16" X 4" (323.85 mm x 284.162 mm x 101.6 mm)

● Red	IMS-1400
● Gray	IMS-1401
○ White	IMS-1402
● Orange	IMS-1403
● Purple	IMS-1404
● Yellow	IMS-1405
● Lavender	IMS-1406
● Black	IMS-1407
● Blue	IMS-1408
● Green	IMS-1409
● Ocean Blue	IMS-14011

*These antimicrobial properties are built in to protect the product. This product does not protect users against bacteria, viruses, germs or other disease organisms. Clear components and tub liner do not contain antimicrobial product protection.



Signature Series™ Tub

Tub available in 11 color options. Lid ordered separately.
 12-1/4" x 10-7/8" x 2-3/4" (311.15 mm x 276.225 mm x 69.85 mm)

● Red	IMS-1410
● Gray	IMS-1411
○ White	IMS-1412
● Orange	IMS-1413
● Purple	IMS-1414
● Yellow	IMS-1415
● Lavender	IMS-1416
● Black	IMS-1417
● Blue	IMS-1418
● Green	IMS-1419
● Ocean Blue	IMS-14111

Quick Tip: Red Signature Series™ Tubs can also be used as a solution to transport your contaminated instruments and small cassettes.



Locking Tub Cover **IMS-1420**

Locking tub cover protects items from airborne materials during use, transportation, and storage.
 12-3/4" x 11-3/16" x 2" (323.85 mm x 284.162 mm x 50.8 mm)

Tub Racks



Adjustable 3 Tub Rack **IMS-1433**

Fits most standard storage cabinets. Holds a maximum of 3 tubs with lids or 6 cassettes. Non-slip feet. Sturdy metal construction. No screws, tools nuts or bolts needed.
 Min 9-3/4" Max 16-3/4" x 11-3/4" x 13-11/16"
 (Min 247.65 mm Max 425.45 mm x 298.45 mm x 347.66 mm)



Adjustable 4 Tub Rack **IMS-1434**

Holds a maximum of 4 tubs with lids or 8 cassettes. Sturdy metal construction. Non-slip feet.
 Min 9-3/4" Max 16-3/4" x 11-3/4" x 18"
 (Min 247.65 mm Max 425.45 mm x 298.45 mm x 457.2 mm)



Tub Accessories

Several accessories are available to support organization of disposables needed for each procedure.



Tub Insert

Features 10 compartments for easy organization of tub materials. Sits on rim of tub allowing for storage underneath.

9-3/4" x 10-3/4" x 11/32" (247.65 mm x 273.05 mm x 0.0129 mm)

IMS-1423



Divided Slide Tray

Stores cotton rolls, cotton squares, clamps, syringe tips and more.

9-3/4" x 5-3/8" x 11/16" (247.65 mm x 136.525 mm x 17.463 mm)

IMS-1421



Flat Slide Tray

Can be used to store discs, strips, tofflemire, articulating paper, etc.

9-3/4" x 5-3/16" x 1-3/8" (247.65 mm x 131.762 mm x 34.925 mm)

IMS-1422



Dividers

Includes 8 dividers.

12-3/4" x 11-3/16" X 1-3/8" (323.85 mm x 284.162 mm x 34.925 mm)

IMS-1427



Tub Liner

Non-slip liner prevents small items from slipping under divider sections.

9-5/8" x 8-7/8" X 1/8" (244.475 mm x 225.425 mm x 3.175 mm)

IMS-1428



Capsule Clip-On Holder

Allows quick access to composite material during procedure. Conveniently clips on any side of tub. Holds up to 8 capsules, 4 syringe tubes, and capsule/gun dispenser.

8" x 2-1/2" x 3/4" (203.2 mm x 63.5 mm x 19.05 mm)

IMS-1429



Syringe Clip-On Holder

Allows quick access to composite material during procedure. Conveniently clips on any side of tub. Holds up to 15 syringe tubes and 3 applicator tips.

8" x 2-5/8" x 3/4" (203.2 mm x 66.675 mm x 19.05 mm)

IMS-1430



10-Unit Syringe Add On

An add-on for the Syringe 20 unit stand. Provides additional space for syringe storage. Holds up to 10 syringe tubes.

8-1/2" x 2-3/8" x 3/4" (215.9 mm x 60.325 mm x 19.05 mm)

IMS-1432



20-Unit Syringe Stand

Stands up for easy access to syringes. Lays flat to fit inside a tub or drawer. Holds up to 20 syringe tubes.

9" x 4-3/4" x 2-1/2" (228.6 mm x 120.65 mm x 63.5 mm)

IMS-1431

Tub Cups & Covers

Used to store brushes, clamps, cotton pellets, syringe tips, prophylaxis paste, prophylaxis angle tips, pumice, implant tools, etc. Long tub Cup Cover provides five storage compartments. Dividers are removable for customization. Perfect for storing capsules, discs, abrasive strips, wedges, matrix bands, etc.



Single Tub Cup With Cover

2-1/4" x 1-5/8" x 1-1/8"
(57.15 mm x 41.275 mm x 28.575 mm)

IMS-1424



Double Tub Cup With Cover

3-3/8" x 2-1/4" x 1-1/8"
(85.725 mm x 57.15 mm x 28.575 mm)

IMS-1425



Long Tub Cup With Cover

8-1/3" x 2-1/4" x 1-1/8"
(211.582 mm x 57.15 mm x 28.575 mm)

IMS-1426

Cleaning & Care	C202	Sterilization Wrap	C215
Enzymatic Solutions	C202	IMS™ Autoclave Sterilization Wrap	C215
General Purpose Solutions	C204	IMS™ Universal Sterilization Wrap	C216
Instrument Care and Accessories	C205	Bonded Double Sterilization Wrap	C216
Cleaning Monitoring	C205	Crosstex™ CSR Sterilization Wrap	C217
High-Level Disinfectants & Sterilants	C206	Sterilization Pouches	C218
Rapicide™ OPA/28 High-Level Disinfectant	C206	Bagette™ Self-Sealing Sterilization Pouches	C218
Sani Glut™ Glutaraldehyde 3%	C207	Duo-Check™ Self-Seal Sterilization Pouches	C219
Biological Monitoring	C208	Sure-Check™ Self-Seal Sterilization Pouches	C220
ConFirm Rapid Read 20 Minute Biological Monitoring System	C208	Nylon Self-Seal Sterilization Pouches	C221
Mail-In Biological Monitoring Service	C208	Steri-Coil™ Pouch Dividers	C221
In-Office	C210	Sani-Tube™ Nylon Sterilization Tubing	C222
Chemical Monitoring	C211	Paper Self-Sealing Autoclave Bags	C222
Multi-Parameter & Integrating Indicators	C211	Sterilization Containers	C223
Process Indicators	C212	Containers	C223
Bowie Dick Test Pack	C212	Container Accessories	C224
Sterilization Tape	C213	Labeling & Accessories	C225
Lead-Free Steam Indicator Tape	C213		
IMS™ Autoclave Tape	C214		
Tape Dispensers	C214		

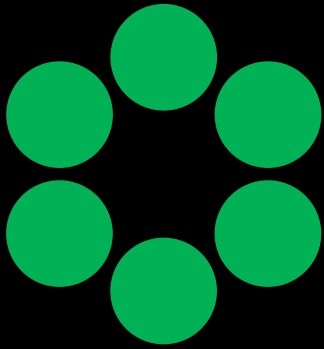

Instrument Reprocessing & Sterilization

Instrument reprocessing is a key part of any office infection control program and must be performed properly to help ensure patient safety. We offer a full line of cleaning and sterilization products to help you optimize staff and patient safety while maximizing office efficiency.



Cleaning & Care

The cleaning step is the essential first step in instrument reprocessing. Cleaning uses specialized solutions, such as enzymatic detergents, to aid in the removal of organic and inorganic matter from instruments. The cleaning efficacy of an automated washer-disinfector and/or an ultrasonic bath can be easily checked with the use of specialized monitors.



Learn more about our [Cleaning & Care products](#).

Enzymatic Solutions

Enzymatic cleaners are used to aid in the cleaning and decontamination of instrumentation and contain enzymes, which help to break down soils, including blood, protein and other proteinaceous debris. These solutions can be used for both manual and automated cleaning processes.



EfferZyme™ Enzymatic and Evacuation Line Cleaning Tablets

Box of 52

JET



Enzymax™ Dual Enzyme Ultrasonic Detergent

Enzymax™ Dual Enzyme Ultrasonic Detergent is specifically formulated for efficient ultrasonic cleaning or pre-soaking of cassettes and instruments. Contains Steelgard® Agents to protect instruments from harmful minerals naturally found in water that contribute to buildup, spotting and corrosion. Can also be used as an evacuation system cleaner. Available in a variety of formats to meet your office needs.



Enzymax™ Liquid Ultrasonic Detergent and Presoak Bottle

Makes 128 gal (485 L)
Gallon (3.785 L)

IMS-1226



Enzymax™ Spray Gel Ready-to-Use Instrument Pre-Cleaner

24 fl oz (709 mL)

IMS-1229



Enzymax™ Liquid Concentrated Ultrasonic Detergent and Presoak

Makes 400 gal (150 L)
40 liquid packets

IMS-1222



Enzymax™ Liquid Concentrated Ultrasonic Detergent and Presoak

Makes 400 gal (150 L)

10 boxes of 40 liquid packets

IMS-1222C



CrossZyme™ Concentrated Ultrasonic Cleaner

Gallon (3.785 L)

JEZ



Sani ProZyme™ Enzymatic Detergent

Gallon (3.8 L)

JED



General Purpose Solutions

General Purpose Ultrasonic Cleaner Concentrate

Ultrasonic solution used for the removal of buffing compounds, pumice, rouge, Tripoli, food particles, foreign matter, and soils of all types. Free rinsing formula leaves instruments/ devices spotless. Use on dentures, burs, bridges, crowns, orthodontic appliances, instruments, diamonds, and glass slides. Concentrated solution: makes 10 gallons.



General Purpose Ultrasonic Cleaner Non-Ammoniated Concentrate

Gallon (3.785 L)

JEZNA

IMS™ Daily Clean

Concentrated powder detergent specifically formulated for efficient ultrasonic cleaning or presoaking of cassettes and instruments.



IMS™ Daily Clean General Purpose Detergent

Makes 160 gal (606 L)

5 lb (2.27 kg)

IMS-1218



IMS™ Daily Clean General Purpose Detergent

Makes 35 gal (132 L)

1.1 lb (500 g)

IMS-1220



Instrument Care and Accessories

Instrument care and maintenance products ensures the proper functioning of instruments, while also minimizes wear.



Instrument Lubricant Spray

Keeps hinged instruments moving freely.

8 oz (236 mL)

ILS



Shine reNEW™ Instrument Wipes

Instrument wipe that effectively removes stain and rust, restoring the luster to stainless steel and tungsten carbide instruments.

20 wipes per canister

IMS-1455

Cleaning Monitoring

Cleaning Monitors are used to monitor the effectiveness of the cleaning process in ultrasonic cleaners and automated washer-disinfectors and provide assurance that your instrumentation has been cleaned properly.



Washer-Disinfector Cleaning Monitor

Used to monitor the effectiveness of the instrument cleaning process in washer-disinfectors.

50 per box

IMS-1200W



Ultrasonic Cleaning Monitor

Used to monitor the effectiveness of the instrument cleaning process in ultrasonic cleaning equipment.

50 per box

IMS-1200U

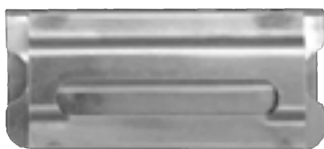

Cleaning Monitor Holder

IMS-1200H



High-Level Disinfectants & Sterilants

High-level disinfectants, also referred to as chemical sterilants or cold sterile solutions, are used to disinfect instruments that cannot be autoclaved.



Learn more about our [High Level Disinfectants & Sterilants](#).

Rapicide™ OPA/28 High-Level Disinfectant

For reprocessing heat-sensitive, semi-critical medical devices that are unsuitable for heat sterilization. High-level disinfection in just 10 minutes at room temperature - 68°F/20°C - with a reuse period of up to 28 days. Use only Rapicide™ Test Strips to verify MRC (minimum recommended concentration) prior to each use.



Rapicide™ OPA/28 High Level Disinfectant
Gallon (3.785 L)
[ML02-0127](#)



Rapicide™ OPA/28 Test Strips
50 per jar
[ML02-0137](#)



Sani Glut™ Glutaraldehyde 3%

Biodegradable and formaldehyde-free reusable liquid chemical sterilant and high-level disinfectant, for use with immersible and heat-sensitive instruments and/or devices. Provides up to 28 days of reuse.



Sani Glut™ Glutaraldehyde 3%
Gallon (3.8L)
JGLUT



SANI HLD Holder
Holds 1 gallon
JHOLD



Biological Monitoring

Biological indicators are the gold standard of sterilization monitoring because they directly determine whether microorganisms are destroyed from the steam sterilization process. We offer a wide range of biological monitoring products for both in-office and mail-in sterilizer monitoring.



Learn more about our [Biological Monitoring](#) products.

ConFirm Rapid Read 20 Minute Biological Monitoring System

Determines the efficacy of steam sterilization cycles in just 20 minutes. Results are automatically provided on the reader LCD display screen, eliminating the need to interpret results.



ConFirm™ Rapid Read 20-Minute Reader
Compact, 8-well, tabletop incubator incubates and automatically reads ConFirm™ Rapid Read Steam BIs at 57°C (135° F)

Each **RR20READER**

ConFirm™ Rapid Read 20-Minute Biological Indicators
Self-contained biological indicators. Determines steam sterilization efficacy of commonly used cycles

25 Count **RR20BI**



Mail-In Biological Monitoring Service

The most comprehensive mail-in service in healthcare committed to protecting your patients, staff and practice. Results available online 24/7 on our secure, confidential website. Immediate test failure notification and complimentary reminder service of missed test date.



ConFirm™ Premium Mail-in Biological Monitoring Service
Includes pre-paid postage. Test strips can not be split between two sterilizers. (Each Packet Contains 2 Test Strips & 1 Control Strip)

6 tests	CST060
12 tests	CST120
48 tests	CST480

ConFirm™ Value Mail-in Biological Monitoring Service
Does not include postage. (Each Packet Contains 1 Test Strip & 1 Control Strip)

12 tests	CVT120
52 tests	CVT520

ConFirm™ Rapid Read 20-Minute System



Twist & Flick Activation
reduces contamination
potential and **eliminates**
need for a separate
activator device

When frequent sterilizer testing is needed and time is of the essence, release an instrument load into service in just 20 minutes.

- An enzyme-based detection system between the biological indicator and reader provides results in just 20 minutes
- Glass-free design helps ensure staff safety
- Simple Twist & Flick activation reduces contamination potential and eliminates need for a separate activator device
- Results are read automatically and indication given via lights at each well of the incubator



To learn more, visit www.hufriedygroup.com/en/sterilization-testing



In-Office

To test if a sterilizer is functioning properly, simply process a test indicator vial in a normal steam sterilization cycle, remove, crush vial and place in incubator along with an unprocessed and crushed control vial for the required incubation period. Media in test vial will stay purple signifying a passed test and will turn yellow if any spores remain alive, indicating a failed test. Growth of surviving spores has been observed in as little as 2.5 hours.

Instrument Reprocessing & Sterilization



ConFirm™ 10 Biological Monitoring System

In-office biological monitoring system that provides final results in 10 hours. ISO 11138-1 and ISO 11138-3 Compliant

ConFirm™ 10 Steam Biological Indicators **C10BI25**
25 per box

Digital Incubator **C10SK**
Includes built-in vial crusher and record keeper booklet

Record Keeper Booklet **CRK02**

Ampule Crusher/Activator **VC-001**



ConFirm™ 24 Biological Monitoring System

In-office biological monitoring system that provides final results in 24 hours. ISO 11138-1 and ISO 11138-3 Compliant

Steam System Starter Kit **CBMS10**
Includes 25 Biological Indicators, Incubator, and Record Keeper

ConFirm™ 24 Steam Biological Indicators **CSBI25**
25 per box

Record Keeper Booklet **CRK02**

Ampule Crusher/Activator **VC-001**



SporeCheck™ 24 Steam System

In-office biological monitoring system that provides final results in 24 hours. ISO 11138-1 and ISO 11138-3 Compliant

Starter Kit **IMS-1376**
Includes 25 Indicators, Dry Block Incubator and Record Notebook

Indicator Vials **IMS-1373**
25 per box

Indicator Vials **IMS-1373H**
100 per box

SporeCheck™ 55-60 Dry Block Incubator **IMS-1374**
Includes built-in vial crusher

Sterilizer Record Notebook **IMS-1375**

Ampule Crusher/Activator **IMS-1377**



Chemical Monitoring

Chemical indicators are used to monitor the sterilization process by changing color or form with exposure to one or more physical conditions of the sterilization process. We offer a range of chemical indicators, from single variable process indicators to more advanced integrating indicators which react to all critical variables.



Learn more about our [Chemical Indicators](#).

Multi-Parameter & Integrating Indicators



Type 5 STEAMPlus™ Integrators

Type 5, multi-variable sterilization monitor designed to react to all critical variables in the sterilization cycle: time, temperature and presence of steam. Utilizes a moving front indicator technology, which is an advancing color bar moving from reject to accept, eliminating the need to interpret or match colors.
4" x 0.75" (101.6 mm x 19.5 mm)

100 per pack

SSI-100

1000 per pack

SSI-1000



STEAMPlus™ Sterilizer Test Pack

Contains a Type 5 STEAMPlus™ Sterilization Integrator inside a challenge pack. Features the SteamPlus™ Type 5 Integrator placed inside of a single use process challenge device test pack. Reacts to all three critical process variables; time, temperature and presence of saturated steam. FDA cleared as equivalent in performance to an AAMI BI Test Pack (PCD). ISO 11140-1 Type 5 Compliant.
6.5" x 4.75" (165.1 mm x 120.65 mm)

25 per box

STP-025



Type 4 Steam Indicator Strips

For use to monitor gravity and prevacuum steam sterilization cycles 121-135C (250-275F). Multi-parameter - indicates if all conditions for steam sterilization have been met, during steam sterilization the check mark turns from white to black.
3.75" x 6.25" (95.25 mm x 158.75 mm)

100 per pack

SCK

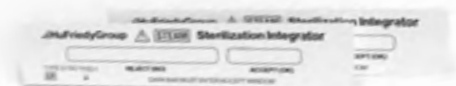

Type 5 IMS Steam Sterilization Integrators

Type 5, multi-variable sterilization monitor designed to react to all critical variables in the sterilization cycle: time, temperature and presence of steam. Utilizes a moving front indicator technology, which is an advancing color bar moving from reject to accept, eliminating the need to interpret or match colors.
4" x 0.75" (101.6 mm x 19.5 mm)

100 per pack

IMS-1241



Process Indicators



Dry Heat Chemical Indicator Strips

Process indicator for use in dry heat sterilizers. Provides a distinct color change from green to dark when processed in dry heat. Writable strip for record keeping. ISO 11140-1 Type 1 Compliant. 3.94" x 0.62" (100mm x 16mm)

100 per pack

DIS-100



IMS Steam Sterilization Indicators

Indicator strips verify that steam sterilization parameters of time and temperature have been met. Use one in each cassette or pouch sterilized and retain for office records. For use in steam sterilizers 250°F–285°F (121°C–141°C). ISO 11140-1 Type 1 Compliant. 4" x .56" (101.6mm x 14.2mm)

250 per box

IMS-1240

Bowie Dick Test Pack



Type 2 AirView™ II Bowie-Dick Test Pack

The Bowie Dick Test Pack detects the presence of air in pre-vacuum (type B) steam sterilizers. Its easy-to-read test sheet clearly identifies failures and can be filed for record keeping. Includes lead-free ink that reduces amount of hazardous waste and can be disposed in regular trash. Compact size of the Bowie Dick Test Pack reduces waste and storage and is ISO 11140-1 Type 2 Compliant. 5" x 3.75" (127 cm x 95.25 cm)

30 per box

MBD030



Sterilization Tape

Indicator tape is designed to hold wrapped packs together and to demonstrate that the pack has been exposed to the steam sterilization process. The chemical process indicator ink provides a distinct ink color change from beige to dark brown/black which easily distinguishes between processed and unprocessed packs. Pre-printed tape is available with specific procedural set-ups, colors or blank.



Learn more about our [Sterilization Tape](#).

Lead-Free Steam Indicator Tape

Made with adhesive and ink that is free of natural rubber latex, lead or solvents; safer for your patients, staff and the environment. Validated for use with all common dynamic-air-removal (pre-vacuum / SFPP) and gravity steam sterilization cycles. Available in 3/4" (18 mm) and 1" (24 mm) width by 60 yd (55 m.)



Lead Free Blank Indicator Tape

Made with adhesive and ink that is free of natural rubber latex, lead, or solvents. Safer for patients, staff, and the environment. Validated for use with all common dynamic air removal (pre-vacuum/SFPP) and gravity steam sterilization cycles.

.75" x 60 yds (18 mm x 55 m)

IMS-1461

1" x 60 yds (24 mm x 55 m)

STLF24MM

.75" x 60 yds (18 mm x 55 m)

STLF18MM



IMS™ Autoclave Tape

Pre-printed indicator tape with specific procedural set-ups or colors, helps to organize and identify pack contents. Available in 3/4" (19 mm) x 60 yards (55 m) per roll.



Pre-printed indicator tape with specific procedural set-ups or colors to help organize and identify pack contents.

Lead Free Blank Indicator Tape .75" x 60 yds (18 mm x 55m)

Procedure	
Cement	IMS-1253
Composite	IMS-1254
Endo	IMS-1255
Exam	IMS-1256
Extraction	IMS-1257
Perio	IMS-1258
Prophy	IMS-1259
Pedo	IMS-1260
Orthodontic	IMS-1243
Restorative	IMS-1247
Surgery	IMS-1248
Amalgam	IMS-1251
C and B	IMS-1252
Color	
Gray	IMS-1262
Orange	IMS-1263
Purple	IMS-1264
Yellow	IMS-1265
Red	IMS-1266
Green	IMS-1267
Blue	IMS-1268
Black	IMS-1269

Tape Dispensers

Tape dispensers hold nine or four rolls of indicator tape. Rubber suction cups on the base secure dispenser to table or counter. Dispenser can also be mounted under cabinet.



IMS™ Tape Dispenser
10.75" x 6.25" x 7.6" (273 mm x 159 mm x 194 mm)
Holds 9 rolls
[IMS-1270](#)



IMS™ Mini Tape Dispenser
4.4" x 6.25" x 7.6" (111 mm x 159 mm x 194 mm)
Holds 4 rolls
[IMS-1270H](#)



Sterilization wraps are used to wrap instrument sets and cassettes for sterilization. Wraps allow the penetration of steam to sterilize the contents and maintain sterility of the processed item after sterilization. We offer a number of wrap options to meet your needs.



Learn more about our [Sterilization Wrap](#).

IMS™ Autoclave Sterilization Wrap

Our IMS™ Autoclave Sterilization Wrap is engineered to withstand the harsh conditions of steam sterilization, and offers the best combination of softness and added strength. Its low linting helps minimize potential sterilizer malfunction. Its memory free wrap lays flat once opened post sterilization.



Autoclave Sterilization Wrap	
12" X 12" (305 mm x 305 mm), 1000 sheets	IMS-1213
12" X 12" (305 mm x 305 mm), 100 sheets	IMS-1213H
15" X 15" (380 mm x 380 mm), 1000 sheets	IMS-1211
15" X 15" (380 mm x 380 mm), 100 sheets	IMS-1211H
20" X 20" (508 mm x 508 mm), 500 sheets	IMS-1212
20" X 20" (508 mm x 508 mm), 100 sheets	IMS-1212H
24" X 24" (610 mm x 610 mm), 500 sheets	IMS-1210
24" X 24" (610 mm x 610 mm), 100 sheets	IMS-1210H



IMS™ Universal Sterilization Wrap

Our unique compilation of textiles is designed to be strong and soft for durability and easy wrapping. Universal Wrap provides great performance at a lower cost.



Universal Sterilization Wrap

12" X 12" (305 mm x 305 mm), 1000 sheets	IMS-1217
12" X 12" (305 mm x 305 mm), 100 sheets	IMS-1217H
15" X 15" (380 mm x 380 mm), 1000 sheets	IMS-1215
15" X 15" (380 mm x 380 mm), 100 sheets	IMS-1215H
20" X 20" (508 mm x 508 mm), 500 sheets	IMS-1216
20" X 20" (508 mm x 508 mm), 100 sheets	IMS-1216H
24" X 24" (610 mm x 610 mm), 500 sheets	IMS-1214
24" X 24" (610 mm x 610 mm), 100 sheets	IMS-1214H

Bonded Double Sterilization Wrap

Bonded Double Wrap is made from two bonded sheets of SMS polypropylene material allowing dental practitioners to be in compliance with the most stringent sterilization standards for healthcare settings set forth by ANSI/ AAMI ST79 and CDC Guidelines. Its edges are ultrasonically bonded together to form a single, two-ply application that provides enhanced safety and increased efficiency and productivity during wrapping and unwrapping. The two sheets are different colors which aids in identifying breaches in the packaging post sterilization and allows package differentiation by color. High strength and durability aid in resistance to tears and punctures, protecting contents of the package during storage and transportation. Compatible with the most common sterilization cycles, the material is also recyclable for reduced waste. Manufactured for single use only.



Bonded Double Sterilization Wrap

15" X 15" (380 mm x 380 mm), 480 sheets	IMS-2215
20" X 20" (508 mm x 508 mm), 480 sheets	IMS-2220
24" X 24" (610 mm x 610 mm), 240 sheets	IMS-2224



Crosstex™ CSR Sterilization Wrap

Our Crosstex™ CSR Sterilization Wrap is manufactured from environmentally-friendly cellulose material made from wood pulp, not petroleum, eliminating skin sensitivity issues associated with oily residues inherent in plastic based wrappers. This wrap serves as a bacterial barrier to both airborne and waterborne contamination.



Crosstex™ CSR Sterilization Wrap	
12" x 12" (300 mm x 300 mm), 1000 sheets	SW12
15" x 15" (380 mm x 380 mm), 500 sheets	SW15
18" x 18" (460 mm x 460 mm), 500 sheets	SW18
20" x 20" (510 mm x 510 mm), 500 sheets	SW20
24" x 24" (610 mm x 610 mm), 500 sheets	SW24
30" x 30" (760 mm x 760 mm), 250 sheets	SW30
36" x 36" (910 mm x 910 mm), 250 sheets	SW36



Sterilization Pouches

Sterilization Pouches are used to package instruments for sterilization. They allow sterilization of the enclosed instrumentation and maintain sterility post sterilization, while providing aseptic delivery. Sterilization pouches are designed to contain a single instrument, multiple instruments or instrument cassettes depending upon the pouch size.

Bagette™ Self-Sealing Sterilization Pouches

Bagette™ Self-Sealing Sterilization Pouches include process indicators located both internal and external to the instrument/cassette area that respond to all sterilization variables: time, temperature and saturated steam. Thick, strong seals protect against cassette and instrument breaches. Medical grade paper provides strength and durability. Multi-layer blue film allows user to easily see any tears in film. Their thumb notch allows for easy opening of the pouch. A wide self-seal adhesive strip easily and securely seals pouch to provide reliable seal. Not made with lead or natural rubber latex.

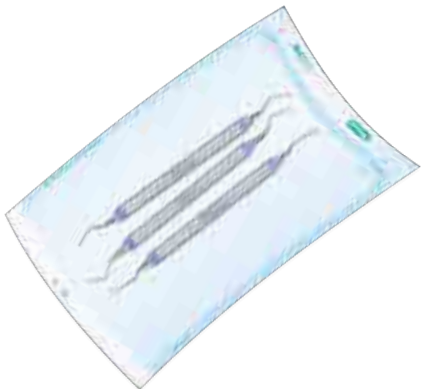

Bagette™ Self-Sealing Sterilization Pouches	
2 1/4" x 4" (57 mm x 102 mm), 200 per box	IMS-1346
2 3/4" x 9" (70 mm x 229 mm), 200 per box	IMS-1347
3 1/2" x 9" (89 mm x 229 mm), 200 per box	IMS-1236
5 1/4" x 10" (133 mm x 254 mm), 200 per box	IMS-1348
7 1/2" x 13" (190 mm x 330 mm), 100 per box	IMS-1237
10" x 14" (254 mm x 356 mm), 100 per box	IMS-1238
12" x 17" (305 mm x 432 mm), 100 per box	IMS-1239
13" x 20" (330 mm x 508 mm), 100 per box	IMS-1345



Duo-Check™ Self-Seal Sterilization Pouches

Duo-Check™ Pouches include built-in internal/external process indicators that change color when exposed to a specific temperature. Manufactured from medical grade paper with extra-wide chevron to protect against instrument breaching, thumb-notch for easy opening. Their 6 corner tack seals prevent curling and other potential contaminants from entering pouch upon opening and a perforated fold to help ensure the adhesive strip forms an airtight seal. Once sterilized, contents will remain sterile for up to 3 years provided the integrity of the pouch has not been compromised. For use with steam and EtO sterilization processes. Not made with natural rubber latex.



Duo-Check™ Self-Seal Sterilization Pouches	
2" x 8" (50 mm x 200 mm), 200 per box	SCZ
2.25" x 4" (60 mm x 100 mm), 200 per box	SCXX
2.75" x 9" (70 mm x 230 mm), 200 per box	SCX
3.25" x 9" (80 mm x 230 mm), 200 per box	SCQ
3.5" x 5.25" (90 mm x 130 mm), 200 per box	SCXS
3.5" x 9" (90 mm x 230 mm), 200 per box	SCS
3.5" x 9" (90 mm x 230 mm), 500 per box	SCS5
3.5" x 22" (90 mm x 560 mm), 100 per box	SCL322
4.25" x 11" (110 mm x 280 mm), 200 per box	SCB1X
5.25" x 10" (130 mm x 250 mm), 200 per box	SCM
5.25" x 15" (130 mm x 380 mm), 200 per box	SCL515
7.5" x 13" (190 mm x 330 mm), 200 per box	SCL
8" x 16" (200 mm x 410 mm), 200 per box	SCL816
10" x 15" (250 mm x 380 mm), 100 per box	SCL1015
12" x 15" (300 mm x 380 mm), 100 per box	SCL1215
12" x 18" (300 mm x 460 mm), 100 per box	SCL1218



Sure-Check™ Self-Seal Sterilization Pouches

Sure-Check™ Pouches contain built-in, multi-parameter internal/external process indicators that change color when all three criteria for sterilization have been met – time, temperature and pressure (steam). These pouches are manufactured from medical grade paper with extra-wide chevron to protect against instrument breaching. Thumb-notch for easy opening. Sure-Check™ Pouches include six corner tack seals to prevent curling and other potential contaminants from entering pouch upon opening. Perforated folds help ensure the adhesive strip forms an airtight seal. For use with steam and EtO sterilization processes only. Not made with natural rubber latex.



Sure-Check™ Self-Seal Sterilization Pouches		
2.25" x 4" (60 mm x 100 mm), 200 per box	SCXX2	
2.75" x 9" (70 mm x 230 mm), 200 per box	SCX2	
3.5" x 5.25" (90 mm x 130 mm), 200 per box	SCXS2	
3.5" x 9" (90 mm x 230 mm), 200 per box	SCS2	
3.5" x 9" (90 mm x 230 mm), 500 per box	SCS25	
3.5" x 22" (90 mm x 560 mm), 100 per box	SCL3222	
5.25" x 6.5" (130 mm x 170 mm), 200 per box	SCW2	
5.25" x 10" (130 mm x 250 mm), 200 per box	SCM2	
5.25" x 15" (130mm x 380 mm), 200 per box	SCL5152	
7.5" x 13" (190 mm x 330 mm), 200 per box	SCL2	
8" x 16" (200 mm x 410 mm), 200 per box	SCL8162	
10" x 15" (250 mm x 380 mm), 100 per box	SCL10152	
10.5" x 17" (270 mm x 430 mm), 100 per box	SCL10172	
12" x 15" (300 mm x 380 mm), 100 per box	SCL12152	
12" x 18" (300 mm x 460 mm), 100 per box	SCL12182	



Nylon Self-Seal Sterilization Pouches

Features built-in adhesive tape which eliminates the need for a heat sealer or indicator tape. Each pouch is notched for ease of opening after processing, and complimentary external chemical indicator labels are included with every box.



Nylon Self-Seal Pouch	
100 per box	
2"x 10" (51 mm x 254 mm)	NSP-400
3"x 10" (76 mm x 254 mm)	NSP-405
4"x 10" (102 mm x 254 mm)	NSP-410
7"x 10.5" (178 mm x 267 mm)	NSP-420
9.5"x13 (241mm x 330 mm)	NSP-430

Steri-Coil™ Pouch Dividers

Stainless steel dividers for placement of pouches in sterilizer. Our Steri-Coil™ Pouch Dividers ensure proper loading and sterilization of contents.



Steri-Coil™ Pouch Divider	
3.5" x 3.5" x 20" (89 mm x 89 mm x 508 mm)	SCD-001
2.5" x 6" (64 mm x 152 mm)	SCD-012



Sani-Tube™ Nylon Sterilization Tubing

Our Sani-Tube™ Nylon Sterilization Tubing is manufactured from clear, puncture-resistant 1.5” mil nylon. For use in steam and dry heat sterilization processes only.

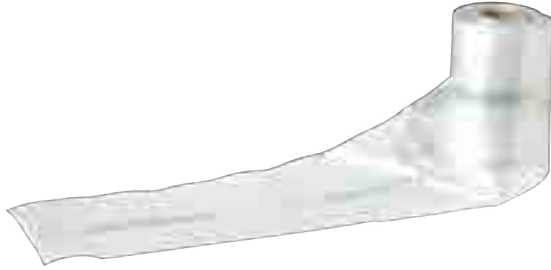

Sani-Tube™ Nylon Sterilization Tubing with Indicators	
100 foot (30 m) roll	
2" x 100 ft (50 mm x 30 m)	SI2
3" x 100 ft (80 mm x 30 m)	SI3
4" x 100 ft (100 mm x 30 m)	SI4
6" x 100 ft (150 mm x 30 m)	SI6

Sani-Tube™ Nylon Sterilization Tubing	
100 foot (30 m) roll	
2" x 100 ft (50 mm x 30 m)	SN2
3" x 100 ft (80 mm x 30 m)	SN3
4" x 100 ft (100 mm x 30 m)	SN4
6" x 100 ft (150 mm x 30 m)	SN6

Paper Self-Sealing Autoclave Bags

Our Paper Self-Sealing Autoclave Bags include double-fold seals with pull-off adhesive tab. Gusset feature provides 50% more space. Contains color process indicators for steam sterilization.



Self-Sealing Paper Autoclave Bags	
1000 per carton	
2.5" x 10.5" x 1.5" Gusset (64 mm x 267 mm x 38 mm Gusset)	OC
2.5" x 8.75" x 1.5" Gusset (64 mm x 222 mm x 38 mm Gusset)	OCS



Sterilization Containers

Sterilization Containers are a reusable, rigid system used for the packaging of cassettes and instruments during sterilization. An alternative to the wrap and pouch materials commonly used to package cassettes and instruments, Sterilization Containers provide significant economic and environmental benefits along with enhanced safety.



Learn more about our [Sterilization Containers](#).

Containers

Sterilization Containers are uniquely sized to fit many Hu-Friedy cassettes, including the Container Cassette that features an integrated handle for easy insertion and removal. Available in four sizes to hold a variety of contents. Suitable for use in pre-vacuum Steam Sterilizers.

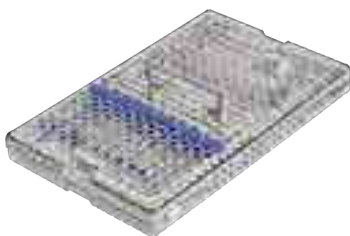

Sterilization Container	
<i>Holds 1 Container Cassette</i>	
12.25" x 7.5" x 2" (312 mm x 190 mm x 50 mm)	IMDINCO0M
12.25" x 7.5" x 2.5" (312 mm x 190 mm x 65 mm)	IMDINCO1M
<i>Holds 2 Container Cassette</i>	
12.25" x 7.5" x 4" (312 mm x 190 mm x 100 mm)	IMDINCO2M
<i>Holds 3 Container Cassette</i>	
12.25" x 7.5" x 5.33" (312 mm x 190 mm x 135 mm)	IMDINCO3M
Container Cassette for 12 Instruments	
Blue	
10.5" x 7" x 1.33" (268 mm x 176 mm x 34 mm)	IMECC128



Container Accessories



Container Indicator Card, Single Use

Container Indicator Cards should be placed on the outside of Sterilization Containers each time the container is sterilized in order to indicate proper exposure to sterilization parameters. Cards contain space to indicate key information including sterilization date, sterilizer # and load number. Single Use Only. Type 1 chemical indicator.

250 pieces

IMCO-INDNA



Tamper Evident Seal for Sterilization Container Latches

Single use tamper evident seals are used to lock the latches of the sterilization container during and after sterilization in order to identify a sterility breach. Seals should be placed in each latch prior to sterilization. Latches are then broken upon opening the Sterilization Container for use. Single Use Only

100 pieces

IMCOM-SEAL

Disposable Paper Filters, Blank, Single Use

Single use filter paper is placed in the lid and body of the Sterilization Containers to allow steam penetration during sterilization and to maintain sterility post sterilization.

100 pieces

IMCO-FIL3M



Labeling & Accessories

Proper labeling of instrument packs is critical for tracking and storage post sterilization. We offer a labeling system that is easy to use on pouches and wrapped cassettes. The CDC recommends that instrument pack labeling include the sterilization date, sterilizer inumber (if using more than one sterilizer) and cycle or load number.



Contact Label Applicator
SDG-001

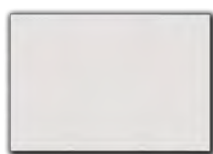

Universal Contact Label
800 labels per roll | 10 rolls per case
Blank
UCL-010
Red
UCL-010-R



Ink Roller Cartridge
IRC-001

Face Masks**C302**

N95 Respirators and Fit Test Kits

C302

ASTM Level 3 Surgical Masks

C304

ASTM Level 2 Surgical Masks

C307

ASTM Level 1 Surgical Masks

C309

Crosstex™ Patient Safety Mask with Shield

C313

Face Shields**C314**

Crosstex™ Disposable Face Shields

C314

Utility Gloves**C315**

Lilac Utility Gloves

C315

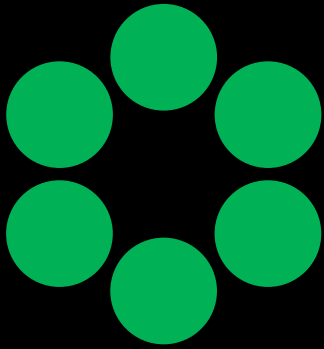

Personal Protective Equipment

Personal Protective Equipment (PPE) is a critical defense against cross contamination. Selecting the most appropriate PPE for a particular procedure or activity should be a key goal of your infection prevention program.



Face Masks

Face Masks cover both the nose and mouth during procedures that may generate aerosols, splashes or sprays of blood or body fluids, and while manually cleaning instruments. We manufacture an extensive portfolio of made-in-USA surgical masks and respirators to meet all your practice needs. Our award-winning, patented Secure Fit™ Technology face masks are the first masks on the market to feature adjustable aluminum nose and chin closures that minimize the potential of inhaling airborne contaminants by reducing gapping around the borders of the mask and provide a custom fit regardless of face shape or size.



Learn more about our [Face Masks and Respirators.](#)

N95 Respirators and Fit Test Kits

NIOSH-approved and FDA-cleared N95 surgical respirators achieve a tight facial fit and protect the wearer from airborne particles and from liquid contaminating the face.



Crosstex™ Isolator™ Duckbill N95 Surgical Respirator

This product is a NIOSH-Approved Surgical N95/FDA-Cleared Respirator with a flat-fold, duckbill design with dual head straps and malleable nose piece for superior filtration, fit and comfort. Indicated for use when treating patients with airborne diseases.

Meets guidelines for TB exposure control.

- Fluid resistant to penetration by synthetic blood at 120mm/Hg
- 99.9% BFE (bacterial filtration efficiency) at 3 microns
- 99.9% PFE (particulate filtration efficiency) at 0.1 micron

Large chamber for enhanced breathability. Soft inner lining for increased comfort. Not made with natural rubber latex. Complies with ASTM F3407- Respirator Fit Capability voluntary standard. 50 per box

GDBRESP



Crosstex™ Isolator™ Molded Surgical N95 Respirator

This NIOSH-Approved Surgical N95/FDA-Cleared Respirator Is durable, collapse-resistant double-shell design. Indicated for use when treating patients with airborne diseases. Meets guidelines for TB exposure control

- Fluid resistant to penetration by synthetic blood at 160 mmHg
 - 99.9% BFE (bacterial filtration efficiency) at 3 microns
 - 99.9% PFE (particulate filtration efficiency) at 0.1 micron
- Soft foam nose cushion and staple-free construction for increased comfort. Contoured, malleable aluminum nose clip and latex-free polymer headstraps for better fit. Not made with natural rubber latex*

GMLRESP



Saccharin N95 Fit Test Kit

The Occupational Safety and Health Administration (OSHA) requires that fit tests be conducted for those who need to wear respiratory protection, including N95 respirators, to ensure proper function and protection. Our Qualitative Fit Test (QLFT) Kits provide the ability to perform pass/fail fit tests that assess the adequacy of respirator fit based on the individual's response to a test agent.

- Simple protocol that is easy to administer
- Includes solution for up to 55 tests
- OSHA and National Institute for Occupational Safety and Health (NIOSH) compliant
- Each kit includes 1 hood, 60 mL test solution, 60 mL sensitivity solution, 2 nebulizers, 4 replacement nozzles, 2 cleaning tools, and a flash drive with instructional information

QLFT-S



Bitrex® N95 Fit Test Kit

The Occupational Safety and Health Administration (OSHA) requires that fit tests be conducted for those who need to wear respiratory protection, including N95 respirators, to ensure proper function and protection. Our Qualitative Fit Test (QLFT) Kits provide the ability to perform pass/fail fit tests that assess the adequacy of respirator fit based on the individual's response to a test agent. It is for use with any disposable filtering facepiece and negative-pressure half-face respirator.

- Simple protocol that is easy to administer
- Includes solution for up to 55 tests
- OSHA and National Institute for Occupational Safety and Health (NIOSH) compliant
- Each kit includes 1 hood, 60 mL test solution, 60 mL sensitivity solution, 2 nebulizers, 4 replacement nozzles, 2 cleaning tools, and a flash drive with instructional information

QLFT-B



ASTM Level 3 Surgical Masks

ASTM Level 3 Surgical Masks are ideal for procedures where heavy to moderate amounts of fluid, spray and/or aerosols are produced.



Crosstex™ Ultra™ Earloop Mask

Crosstex™ Ultra™ Earloop Masks include a fluid resistant outer layer and a fluid resistant white inner layer. Nose piece of mask is extra-long aluminum. Meets EN14683 Rating-Type IIR Standard. Not made with natural rubber latex.

- Fluid Resistance = 160 mmHg
 - BFE ≥98% at 3 microns
 - PFE ≥85% at 0.1 micron
 - Delta P (breathability) <6.0 H2O/cm2
- 40 per box

● Blue

GCFCXU



• Secure Fit™ Mask Technology

Crosstex™ Ultra™ Earloop Mask with Secure Fit™ Mask Technology

Crosstex™ Ultra™ Earloop Masks with Secure Fit™ Mask Technology feature malleable nose and chin strips for a customized fit. Snug, custom fit minimizes gapping for superior protection. Crosstex™ Ultra™ Earloop Masks with Secure Fit™ Mask Technology include a fluid resistant outer layer and a fluid resistant white inner layer. Nose piece of mask is extra-long aluminum. Meets EN14683 Rating-Type IIR Standard. Not made with natural rubber latex.

- Fluid Resistance = 160 mmHg
 - BFE ≥98% at 3 microns
 - PFE ≥85% at 0.1 micron
 - Delta P (breathability) <6.0 H2O/cm2
- 50 per box

● Blue

GCFCXUSF

● Black

GCFBKSF



• FogFree™ Mask

Crosstex™ Ultra™ FogFree™ Earloop Mask

FogFree™ Strip on inner layer reduces fogging. Crosstex™ Ultra™ FogFree™ Earloop Masks include a fluid resistant outer layer and a fluid resistant white inner layer. Nose piece of mask is extra-long aluminum. Meets EN14683 Rating-Type IIR Standard. Not made with natural rubber latex.

- Fluid Resistance = 160 mmHg
 - BFE ≥98% at 3 microns
 - PFE ≥85% at 0.1 micron
 - Delta P (breathability) <6.0 H2O/cm2
- 40 per box

● Blue

GCFCX



Crosstex™ Ultra™ Sensitive Earloop Mask

"Crosstex™ Ultra™ Sensitive Earloop Masks include a fluid resistant outer layer and an extra soft white hypoallergenic inner cellulose layer that will not lint, tear or shred. Nose piece of mask is extra-long aluminum. Meets EN14683 Rating-Type IIR Standard. Not made with natural rubber latex.

- Fluid Resistance = 160 mmHg
 - BFE ≥98% at 3 microns
 - PFE ≥85% at 0.1 micron
 - Delta P (breathability) <6.0 H2O/cm2
- 50 per box

White

GCFCXS



• **Secure Fit™ Mask Technology**

Crosstex™ Ultra™ Sensitive Earloop Mask with Secure Fit™ Mask Technology

Crosstex™ Ultra™ Sensitive Earloop Masks with Secure Fit™ Mask Technology feature malleable nose and chin strips for a customized fit. Snug, custom fit minimizes gapping for superior protection. Crosstex™ Ultra™ Sensitive Earloop Masks with Secure Fit™ Mask Technology include a fluid resistant outer layer and an extra soft white hypoallergenic inner cellulose layer that will not lint, tear or shred. Nose piece of mask is extra-long aluminum. Meets EN14683 Rating-Type IIR Standard. Not made with natural rubber latex.

- Fluid Resistance = 160 mmHg
 - BFE ≥98% at 3 microns
 - PFE ≥85% at 0.1 micron
 - Delta P (breathability) <6.0 H2O/cm2
- 50 per box

White

GCFCXSSF



• **FogFree™ Mask**

Crosstex™ Ultra™ Sensitive FogFree™ Earloop Mask

"FogFree™ Strip on inner layer reduces fogging. Crosstex™ Ultra™ Sensitive FogFree™ Earloop Masks include a fluid resistant outer layer and an extra soft white hypoallergenic inner cellulose layer that will not lint, tear or shred. Nose piece of mask is extra-long aluminum. Meets EN14683 Rating-Type IIR Standard. Not made with natural rubber latex.

- Fluid Resistance = 160 mmHg
 - BFE ≥98% at 3 microns
 - PFE ≥85% at 0.1 micron
 - Delta P (breathability) <6.0 H2O/cm2
- 40 per box

White

GCFCXSF



- FogFree™ Mask
- Secure Fit™ Mask Technology

Crosstex™ Ultra™ Sensitive FogFree™ Earloop Mask with Secure Fit™ Mask Technology

Crosstex™ Ultra™ Sensitive FogFree™ Earloop Masks with Secure Fit™ Mask Technology feature malleable nose and chin strips for a customized fit. Snug, custom fit minimizes gapping for superior protection. FogFree™ Strip on inner layer reduces fogging. Crosstex™ Ultra™ Sensitive FogFree™ Earloop Masks with Secure Fit™ Mask Technology include a fluid resistant outer layer and an extra soft white hypoallergenic inner cellulose layer that will not lint, tear or shred. Nose piece of mask is extra-long aluminum. Meets EN14683 Rating-Type IIR Standard. Not made with natural rubber latex.

- Fluid Resistance = 160 mmHg
 - BFE ≥98% at 3 microns
 - PFE ≥85% at 0.1 micron
 - Delta P (breathability) <6.0 H2O/cm2
- 40 per box

White

GCFCXSFSF



- FogFree™ Mask
- With Shield

Crosstex™ Ultra™ FogFree™ Earloop Mask with Shield

FogFree™ Strip on inner layer reduces fogging. Product includes an attached optically clear, distortion-free wrap-around shield. Crosstex™ Ultra™ FogFree™ Earloop Masks with Shield include a fluid resistant outer layer and a fluid resistant white inner layer. Nose piece of mask is extra-long aluminum. Meets EN14683 Rating-Type IIR Standard. Not made with natural rubber latex.

- Fluid Resistance = 160 mmHg
 - BFE ≥98% at 3 microns
 - PFE ≥85% at 0.1 micron
 - Delta P (breathability) <6.0 H2O/cm2
- 25 per box

Blue

GCPW



- FogFree™ Mask
- With Shield

Crosstex™ Ultra™ Sensitive FogFree™ Earloop Mask with Shield

FogFree™ Strip on inner layer reduces fogging. Product includes an attached optically clear, distortion-free wrap-around shield. Crosstex™ Ultra™ Sensitive FogFree™ Earloop Masks with Shield include fluid resistant outer layer and an extra soft white hypoallergenic inner cellulose layer that will not lint, tear or shred. Nose piece of mask is extra-long aluminum. Meets EN14683 Rating-Type IIR Standard. Not made with natural rubber latex.

- Fluid Resistance = 160 mmHg
 - BFE ≥98% at 3 microns
 - PFE ≥85% at 0.1 micron
 - Delta P (breathability) <6.0 H2O/cm2
- 25 per box

White

GCPWS



- **FogFree™ Mask**
- **Secure Fit™ Mask Technology**
- **With Shield**

Crosstex™ Ultra™ Sensitive FogFree™ Earloop Mask with Shield with Secure Fit™ Mask Technology

Crosstex™ Ultra™ Sensitive FogFree™ Earloop Masks with Shield with Secure Fit™ Mask Technology feature malleable nose and chin strips for a customized fit. Snug, custom fit minimizes gapping for superior protection. FogFree™ Strip on inner layer reduces fogging. Product includes an attached optically clear, distortion-free wrap-around shield. Crosstex™ Ultra™ Sensitive FogFree™ Earloop Masks with Shield with Secure Fit™ Mask Technology include a fluid resistant outer layer and an extra soft white hypoallergenic inner cellulose layer that will not lint, tear or shred. Nose piece of mask is extra-long aluminum. Meets EN14683 Rating-Type IIR Standard. Not made with natural rubber latex.

- Fluid Resistance = 160 mmHg
 - BFE ≥98% at 3 microns
 - PFE ≥85% at 0.1 micron
 - Delta P (breathability) <6.0 H2O/cm2
- 25 per box

White

GCPWSSF

Personal Protective Equipment

ASTM Level 2 Surgical Masks

ASTM Level 2 Surgical Masks are ideal for procedures where moderate to light amounts of fluid, spray and/or aerosols are produced.



Crosstex™ Procedural Earloop Mask

Crosstex™ Procedural Earloop Masks include a fluid resistant outer layer and a fluid resistant white inner layer. Meets EN14683 Rating-Type IIR Standard. Not made with natural rubber latex.

- Fluid Resistance = 120 mmHg
 - BFE ≥98% at 3 microns
 - PFE ≥85% at 0.1 micron
 - Delta P (breathability) <6.0 H2O/cm2
- 50 per box

Blue

GCPBL

Lavender

GCPLV

Pink

GCPPK

Yellow

GCPYE

100 per box

Blue

GCPBL100



• Secure Fit™ Mask Technology

Crosstex™ Procedural Earloop Mask with Secure Fit™ Mask Technology

Crosstex™ Procedural Earloop Masks with Secure Fit™ Mask Technology feature malleable nose and chin strips for a customized fit. Snug, custom fit minimizes gapping for superior protection. Crosstex™ Procedural Earloop Masks with Secure Fit™ Mask Technology include a fluid resistant outer layer and a fluid resistant white inner layer. Nose piece of mask is extra-long aluminum. Meets EN14683 Rating-Type IIR Standard. Not made with natural rubber latex.

- Fluid Resistance = 120 mmHg
 - BFE ≥98% at 3 microns
 - PFE ≥85% at 0.1 micron
 - Delta P (breathability) <6.0 H2O/cm2
- 50 per box

● Blue	GCPBLSF
● Lavender	GCPLVSF
● Pink	GCPPKSF



Crosstex™ Surgical Tie-On Mask

Crosstex™ Surgical Tie-On Masks include a fluid resistant outer layer, a fluid resistant white inner layer, and an extra-large panel for surgical procedures. Nose piece of mask is extra-long aluminum. Meets EN14683 Rating-Type IIR Standard. Not made with natural rubber latex.

- Fluid Resistance = 120 mmHg
 - BFE ≥98% at 3 microns
 - PFE ≥85% at 0.1 micron
 - Delta P (breathability) <6.0 H2O/cm2
- 50 per box

● Blue	GCS
--------	------------



ASTM Level 1 Surgical Masks

ASTM Level 1 Surgical Masks are ideal for procedures where low amounts of fluid, spray and/or aerosols are produced.



Crosstex™ Isofluid™ Earloop Mask

Isofluid™ Earloop Masks include a fluid resistant outer layer and a white medical grade inner layer. Nose piece of mask is extra-long aluminum. Meets EN14683 Rating-Type II Standard. Not made with natural rubber latex.

- Fluid Resistance = 80 mmHg
 - BFE ≥95% at 3 microns
 - PFE ≥80% at 0.1 micron
 - Delta P (breathability) <5.0 H₂O/cm²
- 50 per box

● Blue	GCIBL
● Green	GCIGR
● Lavender	GCILV
● Pink	GCIPK
● Sapphire	GCISA
● Teal	GCITE
● Turquoise	GCITQ

100 per box

● Blue	GCIBL100
--------	-----------------



• **Secure Fit™ Mask Technology**

Crosstex™ Isofluid™ Earloop Mask with Secure Fit™ Mask Technology

Meets EN14683 Rating-Type II Standard. Not made with natural rubber latex.

- Fluid Resistance = 80 mmHg
 - BFE ≥95% at 3 microns
 - PFE ≥80% at 0.1 micron
 - Delta P (breathability) <5.0 H₂O/cm²
- 50 per box

● Blue	GCIBLSF
● Lavender	GCILVSF
● Pink	GCIPKSF



• FogFree™ Mask

Crosstex™ Isofluid™ FogFree™ Earloop Mask

FogFree™ Strip on inner layer reduces fogging. Isofluid™ FogFree™ Earloop Mask includes fluid resistant outer layer and a white medical grade inner layer. Nose piece of mask is extra-long aluminum. Meets EN14683 Rating-Type II Standard. Not made with natural rubber latex.

- Fluid Resistance = 80 mmHg
 - BFE ≥95% at 3 microns
 - PFE ≥80% at 0.1 micron
 - Delta P (breathability) <5.0 H2O/cm2
- 40 per box

● Blue	GCICXB
● Sapphire	GCICXS
● Turquoise	GCICXT



• FogFree™ Mask
• Secure Fit™ Mask Technology

Crosstex™ Isofluid™ FogFree™ Earloop Mask with Secure Fit™ Mask Technology

Isofluid™ FogFree™ Earloop Masks with Secure Fit™ Mask Technology feature malleable nose and chin strips for a customized fit. Snug, custom fit minimizes gapping for superior protection. FogFree™ Strip on inner layer reduces fogging. Isofluid™ FogFree™ Earloop Masks with Secure Fit™ Mask Technology include a fluid resistant outer layer and a white medical grade inner layer. Nose piece of mask is extra-long aluminum. Meets EN14683 Rating-Type II Standard. Not made with natural rubber latex.

- Fluid Resistance = 80 mmHg
 - BFE ≥95% at 3 microns
 - PFE ≥80% at 0.1 micron
 - Delta P (breathability) <5.0 H2O/cm2
- 40 per box

● Blue	GCICXBSF
--------	-----------------



• FogFree™ Mask
• With Shield

Crosstex™ Isofluid™ FogFree™ Earloop Mask with Shield

FogFree™ Strip on inner layer reduces fogging. Product includes an attached optically clear, distortion-free wrap-around shield. Crosstex™ Isofluid™ FogFree™ Earloop Mask with Shield include a fluid resistant outer layer and a white medical grade inner layer. Nose piece of mask is extra-long aluminum. Meets EN14683 Rating-Type II Standard. Not made with natural rubber latex.

- Fluid Resistance = 80 mmHg
 - BFE ≥95% at 3 microns
 - PFE ≥80% at 0.1 micron
 - Delta P (breathability) <5.0 H2O/cm2
- 25 per box

● Blue	GCIPWB
● Sapphire	GCIPWS
● Turquoise	GCIPWT



- **FogFree™ Mask**
- **Secure Fit™ Mask Technology**
- **With Shield**

Crosstex™ Isofluid™ FogFree™ Earloop Mask with Shield with Secure Fit™ Mask Technology

Crosstex™ Isofluid™ FogFree™ Earloop Masks with Shield with Secure Fit™ Mask Technology feature malleable nose and chin strips for a customized fit. Snug, custom fit minimizes gapping for superior protection. FogFree™ Strip on inner layer reduces fogging. Product includes an attached optically clear, distortion-free wrap-around shield. Crosstex™ Isofluid™ FogFree™ Earloop Masks with Shield with Secure Fit™ Mask Technology include fluid resistant outer layer and a white medical grade inner layer. Meets EN14683 Rating-Type II Standard. Not made with natural rubber latex.

- Fluid Resistance = 80 mmHg
 - BFE ≥95% at 3 microns
 - PFE ≥80% at 0.1 micron
 - Delta P (breathability) <5.0 H2O/cm2
- 25 per box

● Blue

GCIPWBSF



- **Plus (soft inner layer)**

Crosstex™ Isofluid™ Plus Earloop Mask

Crosstex™ Isofluid™ Plus Earloop Masks include a fluid resistant outer layer and an extra soft white hypoallergenic inner cellulose layer that will not lint, tear or shred. Nose piece of mask is extra-long aluminum. Meets EN14683 Rating-Type II Standard.

- Fluid Resistance = 80 mmHg
 - BFE ≥95% at 3 microns
 - PFE ≥80% at 0.1 micron
 - Delta P (breathability) <5.0 H2O/cm2
- 50 per box

● Blue

GPLUSBL

● Kaleidoscope

GPLUSKA

● Pink

GPLUSPK



- **Plus (soft inner layer)**
- **Secure Fit™ Mask Technology**

Crosstex™ Isofluid™ Plus Pure Earloop Mask with Secure Fit™ Mask Technology

Crosstex™ Isofluid™ Plus Pure Masks with Secure Fit™ Mask Technology include a fluid resistant outer layer and an extra soft white hypoallergenic inner cellulose layer that will not lint, tear or shred. Nose piece of mask is extra-long aluminum. Meets EN14683 Rating-Type II Standard.

- Fluid Resistance = 80 mmHg
 - BFE ≥95% at 3 microns
 - PFE ≥80% at 0.1 micron
 - Delta P (breathability) <5.0 H2O/cm2
- 50 per box

○ White

GPLUSWHSF



Crosstex™ Le Petit Masque

Le Petit Masques include a fluid resistant pink outer layer and a soft white spunbound inner layer and are smaller than standard earloop masks for a better fit. Not made with natural rubber latex.

- Fluid Resistance = 80 mmHg
 - BFE \geq 95% at 3 microns
 - PFE \geq 80% at 0.1 micron
 - Delta P (breathability) $<$ 5.0 H₂O/cm²
 - Flame Spread Class 1
- 50 per box

● Pink

GCAPTPK



Crosstex™ Patient Safety Mask with Shield

The Crosstex™ Patient Safety Mask with Shield covers a patient's eyes and nose for increased safety, and protects fragile eye and mucosal tissue from flying particles, spray and splatter. An attached clear shield allows optical clarity for patient while a form-fitting profile and flexible materials provide maximum access to mouth.



Crosstex™ Patient Safety Mask with Shield

Covers patient's eyes and nose.

25 per box

White

GCPAT



Face Shields

Use of face shields is recommended during procedures likely to generate splashes, spatter or aerosol. The central areas of the face are the most vulnerable for transmission especially during certain procedures. Use layered PPE like glasses, a mask and a face shield to increase the protection in these areas. Face shields protect your mask and face from direct spatter and may prolong mask life.



Learn more about our [Face Shields](#).

Crosstex™ Disposable Face Shields

Crosstex™ Disposable Face Shields are made of high-quality, made-in-USA film that offers maximum clarity. Anti-fog treatment on both the inside and outside of the shield provides optimum visibility. One and a half inch vented foam headband holds shield away from face to improve airflow while exerting no pressure on temples.



7" Clear Face Shield	
18 per box	GCSS
72 per box	GCSSB
9" Clear Face Shield	
18 per box	GCSS9
72 per box	GCSS9B



Utility Gloves

Chemical and puncture-resistant utility gloves are recommended for cleaning and disinfection and when handling or transporting contaminated instruments.



Learn more about our [Utility Gloves](#).

Lilac Utility Gloves

Three pack of flocklined nitrile utility gloves for use when cleaning and processing instruments. Resists some chemicals better than latex gloves¹ and superior resistance to puncture for improved protection.² Steam autoclavable to 250 °F/121 °C up to five times.



Lilac Utility Gloves

3 pairs per pack

Small (Size 7)	40-060
Medium (Size 8)	40-062
Large (Size 9)	40-064
Extra Large (Size 10)	40-066

1) CDC - https://safety.fsu.edu/safety_manual/supporting_docs/Glove%20selection%20chart%20CDC.pdf

2) Please refer to product technical specification for the penetration times of chemicals tested (available upon request).

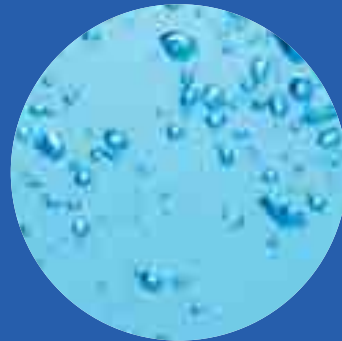
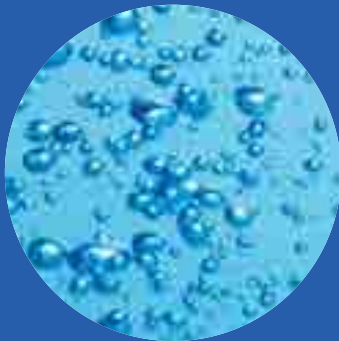
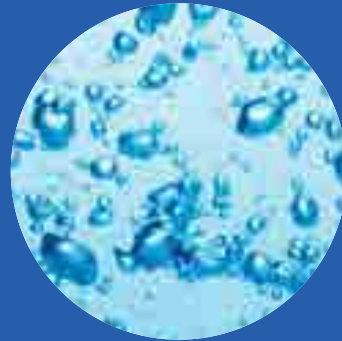
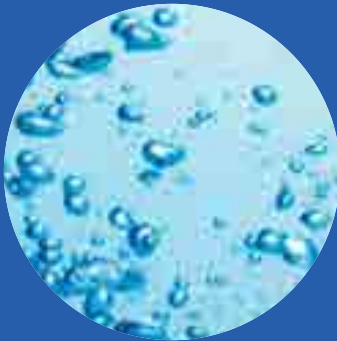
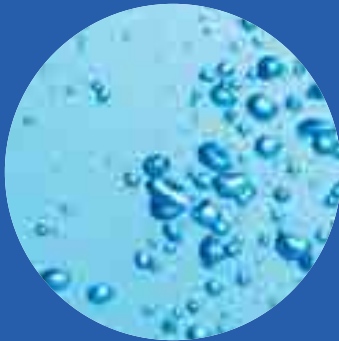
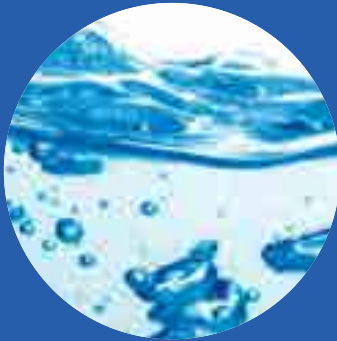

*Compliance = Compliance with current EPA potable water standard of <500 CFU/mL.

Note: some of the devices, products, and/or programs advertised may not be licensed for sale outside the United States. Contact your local sales or customer care representative for availability details. For full product warranty details, please visit [HuFriedyGroup.com/services/warranties](https://www.hufriedy.com/services/warranties)

The contents of this catalog including, but not limited to, all text, photographs and graphics, are the sole and exclusive property of Hu-Friedy Mfg. Co., LLC its affiliates or related companies and may not be copied, reproduced or distributed without prior written permission.

Hu-Friedy Mfg. Co., LLC, 1666 E. Touhy Ave., Des Plaines, IL 60018 | [HuFriedyGroup.com](https://www.hufriedy.com)

All company and product names are trademarks of Hu-Friedy Mfg. Co., LLC its affiliates or related companies, unless otherwise noted. STATIM®, STATCLAVE® and BRAVO™ are registered trademarks and trademarks of SciCan Ltd. Midmark®, M9® and M11® are registered trademarks of Midmark Corporation. VistaCheck™ and DrainHub™ are trademarks of Vista Research Group, Inc.



Dental Water Management

Poor water quality can harm patients, staff and equipment—not to mention the reputation of your practice. Our comprehensive line of dental water products can help to improve patient care, staff productivity and practice profitability, while helping to maintain compliance* with regulatory guidelines.

Dental Unit Waterline Management	D101
Evacuation Line Cleaning	D201
Sterilization Center Water Solutions	D301

Dental Unit Waterline Testing **D102**

Dental Waterline Test Kit, HPC Lab Test D102

24-Hour In-Office Dental Waterline Test Kit D102

Continuous Treatment **D103**

DentaPure™ Cartridges D103

Hu-Friedy Waterline Filter D103

VistaClear™ DP Centralized Waterline Treatment System D104

Periodic Treatment **D105**

Liquid Ultra™ Solution D105

VistaTab™ Dental Waterline Cleaner Tablets D106

Managing Scale and Deposits in DUWLs D106

Accessories **D107**

Iodine Test Strips D107

Hu-Friedy Waterline Filter Shock Accessory Kit D107

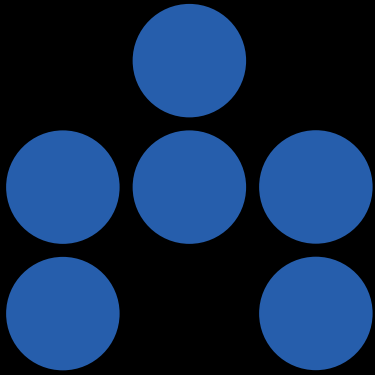

Dental Unit Waterline Management

The long and narrow design of Dental Unit Waterlines (DUWLs) creates the perfect breeding ground for microbial growth. When untreated, or improperly maintained, the water flowing through these contaminated DUWLs and out through dynamic instruments used during treatment can potentially harm your patients, staff and practice reputation.



Dental Unit Waterline Testing

Treatment alone can't provide you the assurance you need in the quality of water in your waterlines. By regularly testing your waterlines, you can be confident in knowing your water is safe and compliant.



Learn more about our [DUWL testing and treatment protocol management](#).

Dental Waterline Test Kit, HPC Lab Test

Our Dental Waterline Test Service delivers accurate test results from a third-party, ISO 17025 accredited laboratory backed by technical competency that meets the highest standards.



Dental Waterline Test Kit, HPC Lab Test

4 Vials	IMS-2004
8 Vials	IMS-2008
16 Vials	IMS-2016

24-Hour In-Office Dental Waterline Test Kit

Our 24-Hour In-Office Dental Waterline Test Kit allows you to easily confirm that your water is safe and compliant.



24-Hour In-Office Dental Waterline Test Kit

4 Vials	IMS-1004
---------	--------------------------



Continuous Treatment

Continuous treatment products are placed inside the independent water bottle or inside a J-box, cabinet or system that is directly plumbed to city water. These products are replaced based on time or water usage.



Learn more about our **Continuous Treatment** products.

DentaPure™ Cartridges

DentaPure™ cartridges elute non-allergenic elemental iodine into dental treatment water for 365 days or 240L. Treated water meets the current potable water standard of <500 CFU/mL and helps to reduce patient and staff bacterial exposure. Cartridges are available for dental units with independent water bottles, or units direct plumbed to city water. Use is not restricted by the EPA rule BMP for dental amalgam waste.



DentaPure™ 40B Cartridge
DP40B10



DentaPure™ DP365B Cartridge
DP365B10



DentaPure™ DP365M Cartridge
DP365M10

Hu-Friedy Waterline Filter

The Hu-Friedy Waterline Filter continuously works to deliver clean water to patients and staff for one year (or 240L). It inhibits growth of microbial contamination in dental waterlines. Treated water meets the current potable water standard of <500 CFU/mL. Ready-to-use cartridge that is easy to install. Use is not restricted by the EPA rule BMP for dental amalgam wastewater.



Hu-Friedy Waterline Filter
IMS-1440



VistaClear™ DP Centralized Waterline Treatment System

The VistaClear™ DP Centralized Waterline Treatment System filters water centrally for directly connected dental operatories and provides a method for delivering compliant*, on-demand procedural water with reduced microbial contamination (<200 CFU/mL) and odor-causing bacteria buildup when used with the EPA registered DentaPure™ cartridge. It eliminates the need for dental bottles and water-storage tanks, and the need for purchased water and waterline tablet treatments for bottle systems.

Dental Unit Waterline Management



VistaClear™ DP Centralized Waterline Treatment System

United States	CVV1000-DP
Canada	CVV1000-DP-CA



Annual Replacement Cartridges for VistaClear™ DP Waterline Treatment System

QAI Certified

DentaPure™ Cartridge	DP365VC
DentaPure™ Cartridge (Canada)	DP365VC-CA
VistaClear™ DP Carbon Block Filter	CVR9725



Learn more about our [VistaClear™ DP Centralized Waterline Treatment System](#).

* Compliance with current EPA potable water standard of <500 CFU/mL.

Periodic Treatment

Periodic Dental Unit Waterline treatments rapidly work to remove bacteria and biofilm and slow the regrowth of biofilm. Following the application of these cleaner/shock products in a dental unit, the residual product must be flushed through the dental unit waterlines prior to patient treatment.



Learn more about our **Periodic Treatment** products.

Liquid Ultra™ Solution

Liquid Ultra™ Solution is a powerful dental unit waterline cleaner/shock with multiple treatment options for external bottle systems. It kills biofilm bacteria; removes existing biofilm and prevents/suppresses formation of biofilm in DUWLs. Use is not restricted by the EPA rule BMP for dental amalgam wastewater.



Liquid Ultra™ Solution

Box of 10 sets of Solution 1 & Solution 2

DS503L



VistaTab™ Dental Waterline Cleaner Tablets

These antimicrobial tablets are used for the cleaning and control of microbial contaminants in dental unit waterlines. When placed in water, the solid tablet quickly dissolves to create an easy-to-use solution. Use is not restricted by the EPA rule BMP for dental amalgam wastewater.



VistaTab™ Dental Waterline Cleaner Tablets

Box of 15 Tablets

IMS-1451

Managing Scale and Deposits in DUWLs

VistaClean™ Irrigant Solution Concentrate is a daily solution derived from organic citrus botanicals that can be used during patient care. It helps prevent waterlines and equipment from deposits and scale and works to emulsify contaminants that can build up in waterlines.



VistaClean™ Irrigant Solution Concentrate

1 fl oz (29.6 mL) bottle

IMS-1452



Accessories

Iodine Test Strips

For all iodinated dental unit waterline maintenance products, including the DentaPure™ cartridge and Hu-Friedy Waterline Filter. These tests strips should only be used to determine the level of iodine present in Dental Unit Waterlines, and should not be used to measure the presence of Colony Forming Units (CFU's). It is recommended to check the iodine level at 11 months, or as you approach 240L of water to ensure that the iodine output has not fallen below 0.5 ppm—particularly if you have a very busy practice.



Iodine Test Strips	DPTEST
50 test strips	

Hu-Friedy Waterline Filter Shock Accessory Kit

The Hu-Friedy Waterline Filter Shock Accessory Kit allows for easy administration of shock treatment through the water bottle when the filter is temporarily removed, or awaiting annual replacement. This kit is designed for use with the Hu-Friedy Waterline Filter.



Hu-Friedy Waterline Filter Shock Accessory Kit	IMS-1440AC
---	-------------------

SaniVac™ Evacuation System Cleaner	D202
EfferZyme™ Enzymatic and Evacuation Line Cleaning Tablets	D202
Enzymax™ Dental Instrument and Evacuation Line Cleaning Solutions	D203

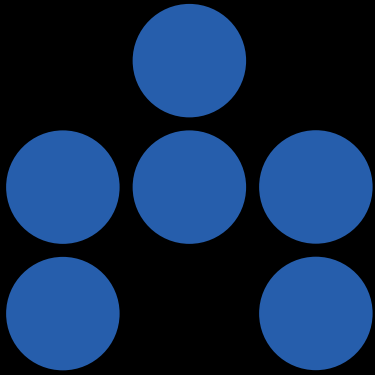

Evacuation Line Cleaning

Maintenance of the entire vacuum system needs to be considered. Untreated evacuation lines form clogs and can become sluggish from the build-up of debris, which can have an effect on the productivity and efficiency of a dental practice. Routine cleaning can help maintain optimal suction and prevent unnecessary downtime and costly line repairs.



SaniVac™ Evacuation System Cleaner

SaniVac™ Evacuation System Cleaner contains a unique, multi-proteolytic enzyme formula that efficiently neutralizes odor and removes a wider range of dental debris than surfactants alone. The non-oxidizing, pH-neutral solution meets the EPA's Best Management Practices for dental amalgam waste. Use daily or after each patient to help avoid downtime and costly line repairs. With SaniVac™ Evacuation System Cleaner, treat up to 384 lines per gallon bottle. Ideal for use in both wet/dry vacuum systems and amalgam separators.



SaniVac™ Evacuation System Cleaner Bottle
Gallon JVAC

EfferZyme™ Enzymatic and Evacuation Line Cleaning Tablets

Enzymatic formula enhances the removal of blood and other soils that may be resistant to chemical detergents. Biodegradable and neutral pH formulation. Contains no chlorine or harsh alkaline ingredients and is non-corrosive to protect instruments. Multi-use; can be used as an ultrasonic cleaner, instrument soak or evacuation system cleaner.



EfferZyme™ Enzymatic and Evacuation Line Cleaning Tablets
Box of 52 JET



Enzymax™ Dental Instrument and Evacuation Line Cleaning Solutions

The Enzymax™ Dental Instrument Cleaning Solutions family of dual enzyme-based detergents can be used for multiple applications, including evacuation system cleaning, ultrasonic cleaning, and pre-soaking of cassettes and instruments. Available in multiple formats to meet your individual needs.



Enzymax™ Liquid Ultrasonic Detergent and Presoak Bottle
Gallon
IMS-1226



Enzymax™ Liquid Ultrasonic Detergent and Presoak
Liquid packets
10 Boxes of 40
IMS-1222C



Enzymax™ Liquid Ultrasonic Detergent and Presoak
Liquid packets
Box of 40
IMS-1222



Enzymax™ Powder Ultrasonic Detergent and Presoak
Container (1.76 LB)
IMS-1230

Water Purification**D302**

VistaPure™ Water Purification System

D302

Wastewater Management**D303**

VistaCool™ Direct-to-Drain Cooling System

D303

Accessories**D304**

VistaCheck™ Backflow Preventer

D304

DrainHub™ Drain Adapter

D305

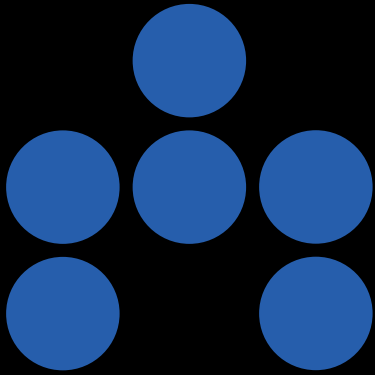

Sterilization Center Water Solutions

From ensuring high-quality water coming into the steri-center to automatically cooling autoclave wastewater before sending to the drain, our steri-center equipment products provide a comprehensive solution for your water needs.

Use the VistaPure™ Water Purification System to produce on-demand high-purity process water for filling sterilizers, dental bottles and more. The self-regulating VistaCool™ Direct-to-Drain Cooling System for Autoclave Wastewater cools and drains autoclave wastewater while significantly increasing workflow efficiency. Additional accessories are available for ease of installation and use.



Water Purification

Poor water quality can damage dental instruments inside instrument washers or interfere with proper sterilization. The VistaPure™ Water Purification System eliminates the need to buy bottled water, distilled water or own a distiller with one convenient system.



Learn more about our [Sterilization Center Water Solutions.](#)

Sterilization Center Water Solutions

VistaPure™ Water Purification System

VistaPure™ Water Purification System produces two grades of high-purity water for autoclaves, dental bottles, ultrasonic cleaners and the rinse cycle of instrument washers. It connects directly to the city water supply and sends purified water anywhere it's needed in the steri-center for easy, on-demand use. Optional, autofill devices replenish SciCan STATIM® Autoclave and BRAVO™ Autoclave reservoirs automatically, enabling truly hands-free convenience. Optional adapter kit sends high-purity water to instrument washers with final-rinse ports to help protect dental instruments from poor-quality water.



VistaPure™ Water Purification System
CVV3000



VistaPure™ BottleFill Remote Water Dispenser
CVS3050

VistaPure™ Instrument Washer Adapter Kit	CVS3010
VistaPure™ STATCLAVE® Adapter Kit	CVS3015
VistaPure™ AutoFill Kit for SciCan STATIM® Autoclave	CVS3020
VistaPure™ AutoFill Kit for SciCan BRAVO™ Autoclave	CVS3030
VistaPure™ Replacement Filter – Prefilter (#1)	CVR3251
VistaPure™ Replacement Filter – Deionization Filter (#2)	CVR3252
VistaPure™ Replacement Filter – Deionization Filter (#3)	CVR3253
VistaPure™ Replacement Filter – Hyperfilter (#4)	CVR3254
VistaPure™ Replacement Filter – Polishing Filter (#5)	CVR3255
VistaPure™ Legacy Filter – Polishing Filter (#5)	CVR2551
VistaPure™ Replacement Filter Pack	CVR3250
VistaPure™ Water Storage Tank (4.25 Gallon)	CVS9111
VistaPure™ Water Storage Tank (9.5 Gallon)	CVS9113
VistaPure™ Autoclave Wand	CVS9300
VistaPure™ BottleFill Remote Water Dispenser	CVS3050



Wastewater Management

The wastewater produced during the process of steam sterilization can often be problematic. Many autoclaves discharge steaming-hot condensation after each sterilization cycle, which is typically collected in a bottle that dental staff members must monitor continuously and empty manually throughout the week. Not only is this process time-consuming and inefficient, but steam and spills from condenser bottles can also damage sterilization center cabinetry.



Learn more about our [Wastewater Management](#) products.

VistaCool™ Direct-to-Drain Cooling System

The VistaCool™ Direct-to-Drain Cooling System protects drains by preventing autoclave wastewater from melting plumbing. It also protects cabinets by helping to prevent mildew, rot, rust and delamination caused by spills and humid environments created by autoclave condenser bottles. VistaCool™ System saves staff time by eliminating the need to empty steaming-hot water bottles manually.



VistaCool™ Single-Autoclave Cooling System
CVV7501

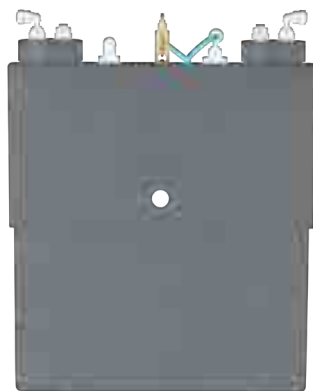

VistaCool™ Double-Autoclave Cooling System
CVV7502

VistaCool™ Adjustable Tank Stand for Single-Autoclave Cooling System
CVS7545

VistaCool™ Adjustable Tank Stand for Double-Autoclave Cooling System
CVS7547

VistaCool™ Adapter Kit for Midmark® M9® & M11® Autoclaves
CVS7560



Accessories

VistaCheck™ Backflow Preventer

VistaCheck™ Backflow Preventer is a QAI certified dual check valve backflow prevention device can eliminate the need for reduced pressure zone (RPZ) valves, vacuum breakers, and air gaps. It's made from medical-grade components suitable for food contact. Generally accepted by state and local code authorities as suitable for backflow and cross-connection protection.



VistaCheck™ Dual Check Valve Backflow Preventer

1/4" (6.35 mm)

CVVC250-A

DrainHub™ Drain Adapter

The DrainHub™ Drain Adapter is QAI certified and accepts up to eight drain connections in one small hub, saving space, cost and time. It is easy to install: top and bottom slip hubs accept 1-1/2" pipe; bottom hub glues into 2" coupling. DrainHub Drain Adapter has 1/2" NPT threaded ports accept a variety of push-to-connect, compression, and hose barb adapter fittings.



DrainHub™ Multi-Port Drain Adapter	
2-Port	CVDH152
4-Port	CVDH154
8-Port	CVDH158
DrainHub™ Fittings Accessory Kit	
20 Fittings	CVDH8200
DrainHub™ (8-Port) with Fittings Accessory Kit	
Accessory Kit	CVDH158-82



Note: some of the devices, products, and/or programs advertised may not be licensed for sale outside the United States. Contact your local sales or customer care representative for availability details. For full product warranty details, please visit [HuFriedyGroup.com/services/warranties](https://www.hufriedy.com/services/warranties)

The contents of this catalog including, but not limited to, all text, photographs and graphics, are the sole and exclusive property of Hu-Friedy Mfg. Co., LLC its affiliates or related companies and may not be copied, reproduced or distributed without prior written permission.

Hu-Friedy Mfg. Co., LLC, 1666 E. Touhy Ave., Des Plaines, IL 60018 | [HuFriedyGroup.com](https://www.hufriedy.com)

Accu-Vac™, Accutron™, Axxess™, ClearView™, Digi-Flo™, Digital Ultra™, Newport™, PIP+™, and RFS™ are trademarks of Hu-Friedy Mfg. Co., LLC, its affiliates or related companies. All other company and product names are trademarks of their respective owner.



Nitrous Oxide/ Oxygen Sedation

We provide industry leading solutions by Accutron for nitrous oxide/oxygen sedation. The wide portfolio of products are designed to meet the needs of both the patient and the practice.

For the patient, N₂O/O₂ sedation helps reduce anxiety, makes time pass faster and has some analgesic effects. Plus, it easily clears from the bloodstream after 5 minutes of oxygen. For the practice, the calming benefits of nitrous oxide/oxygen sedation lead to more cooperative patients, a less stressful environment for the staff and potential for increased efficiency. With higher patient satisfaction, less patients canceling and more referrals after a good experience, implementing a nitrous system can provide a valuable additional revenue stream.

The Accutron line includes flowmeters, manifolds, single-use nasal masks, scavenging systems and much more.



Learn more about all our N₂O/O₂ products, view our full Nitrous Oxide/Oxygen Sedation Catalog

Delivery Options

E3

Flowmeters and Manifolds

E101

Nasal Masks

E201

Scavenging Circuits

E301

Portable

E4

Centralized

E4

Chairside

E5

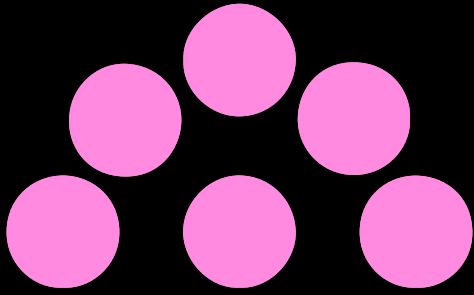

Delivery Options

We offer a variety of portable, centralized, and chairside options to best fit your practice's operation and size.



Flexible options for your practice to deliver N₂O/O₂ sedation:



Portable

- Can move between operatories for increased flexibility.
- Occupies less space and no requirement for central storage unit.
- Utilizes E cylinders and is an optimal solution when frequency of administration is low.
- Available in enclosed option to keep cylinders out of sight and make disinfection faster.

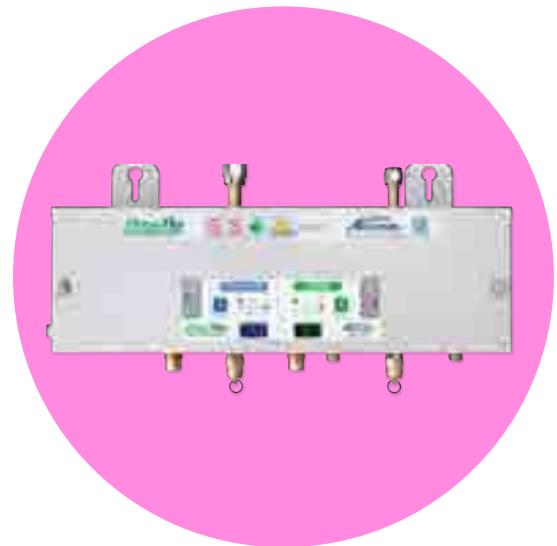

Centralized

- Optimal solution when nitrous oxide/oxygen sedation is used frequently.
- Requires central storage area for cylinders and initial investment in gas storage system.
- Utilizes G and H cylinders so more cost-effective over time.



Chairside

- Eliminate long mixed gas and vacuum hoses draping from adjacent cabinets.
- Create uncluttered, safer work zone for doctor and staff.
- Minimize displacement of patient mask caused by drag/pull and weight of long hoses.
- Kits available for a wide variety of dental chair brands.

For questions about how to best set up nitrous oxide/oxygen sedation in your practice:



Call our Customer Care team at [\(800\) 531-2221](tel:8005312221).



Email our Customer Care team at ccacutron@hu-friedy.com.



Learn more about our entire line of [Accutron™ Products](#).

Accutron™ Digital Ultra™ Flowmeters

E102

**Accutron™ Digi-Flo™ Automatic
Switching Manifold**

E104

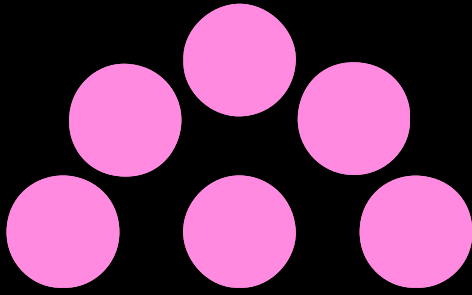

Flowmeters and Manifolds

We offer a full line of equipment solutions to implement N₂O/O₂ sedation into your practice - your way. Our Accutron™ Digital Ultra™ Flowmeters are available in both mounted and portable configurations so you can choose what best fits your operatory set up. If a plumbed system is what you want, our Accutron™ Digi-Flo™ Automatic Switching Manifold will seamlessly distribute the gases to your operatories and on to your flowmeter with the proper outlets and hoses.



Accutron™ Digital Ultra™ Flowmeters

The Accutron™ Digital Ultra™ Flowmeters are designed for clinicians who prefer to work in a digital environment but want critical parameters displayed both numerically and as electronic flow tubes. With multiple configurations available to suit the needs of your practice, the Accutron™ Digital Ultra™ Flowmeter also features color-coded, fingertip controls, a sealed flush surface for easy disinfection or barrier protection and a clean, contemporary design.

Flowmeters and Manifolds



Accutron™ Digital Ultra™ Flowmeter

Automatic compensation makes it easy to adjust total flow or gas ratio while the other stays constant. Accutron™ Digital Ultra™ Flowmeters include digital and electronic flowtube displays for ease of use. These flowmeters come with audible and visual alarms to notify of low oxygen, an oxygen fail-safe and flush for additional safety, and emergency oxygen resuscitation connector.

Accutron™ Digital Ultra™ Flowmeter	51975
Accutron™ Digital Ultra™ Package B — 4-Cylinder Portable	56100
Accutron™ Digital Ultra™ Package C — Adjustable Mobile Stand	56200
Accutron™ Digital Ultra™ Package C — Mobile Stand	56200-ADJS
Accutron™ Digital Ultra™ Package D — 9-inch Wall Arm	56300
Accutron™ Digital Ultra™ Package E — 16-inch Bi-fold Arm	56400
Accutron™ Digital Ultra™ Package F — Telescoping Wall Arm	56500



Accutron™ Digital Ultra™ Flushmount

Accutron™ Digital Ultra™ Flushmount Package G **56600**

Accutron™ Digital Ultra™ Flushmount Package H — Remote Flow System **56800**

Accutron™ Digital Ultra™ Flushmount Package H CHAIR — Remote Flow System for RFS Chairmount Kits (sold separately) **56800-CHAIR**

Accutron™ Digital Ultra™ Flushmount Package I— for Accu-Vac™ System **56950**



Accutron™ Digital Newport™ Flowmeter System **51000**

The Accutron™ Digital Newport™ Flowmeter System has all of the operating features of the Accutron™ Digital Ultra™ Flowmeter, plus its enclosed 4-cylinder design makes it a user-friendly portable that can easily be moved from operator to operator. The unit's height allows it to be stored under counter space that is open below. If not stored, its flat surface can function as additional counter space.



Learn more about our **Accutron™ Digital Ultra™ Flowmeters.**



Accutron™ Digi-Flo™ Automatic Switching Manifold

The Accutron™ The Digi-Flo™ Automatic Switching Manifold/Alarm is designed to safely and economically deliver nitrous oxide and oxygen gases to dental operatories. Regulators control the gas line pressure at 50-55 psi, and a pressure relief valve protects the gas lines and equipment against excessive line pressure. In the event of line pressure changes, the alarm system provides audio and visual alerts.

Accutron™ Digi-Flo™ Automatic Switching Manifold includes an automatic cylinder changeover and alarm with audio and visual warnings and is designed to safely and precisely provide uninterrupted gas supply to the dental operator. A pre-install mounting bracket allows effortless installation while LEDs provide clear and precise numeric line pressure readings.



Learn more about
[Accutron™ Digi-Flo™ Automatic Switching Manifold.](#)



Accutron™ Digi-Flo™ Automatic Switching Manifold

18" x 9" x 3"

Wall Alarm **49250**
 Package B with Pre-Install Kit

Wall Alarm & Security System **49450**
 Package D with Pre-Install Kit

Accutron™ ClearView™ Nasal Masks	E202
Accutron™ Axess™ Nasal Masks	E203
Accutron™ PIP+™ Nasal Masks	E204
Accutron™ Multi-Use Nasal Masks	E205
Capnography Adaptors and Bundles	E206

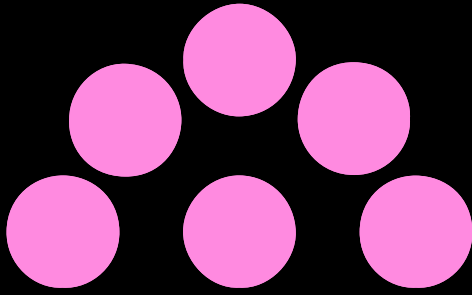

Nasal Masks

We offer four different types of Nasal Masks, in addition to capnography solutions, so you are sure to find a delivery solution that fits your practice. Since introducing our original Accutron™ Personal Inhaler Plus+™ Mask (PIP+) Nasal Mask design, dentistry has evolved and so have we. Our popular mask-in-mask Accutron™ ClearView™ Nasal Mask design and low profile Accutron™ Axess™ Nasal Mask design provide sleek, comfortable options for patients with helpful features for clinicians, as well. And with the American Dental Association's recommendation for single-use masks, we are the only manufacturer with three different types to choose from.



Accutron™ ClearView™ Nasal Masks

The mask-in-mask design of Accutron™ ClearView™ Nasal Masks minimize ambient nitrous oxide in operatory. The clear outer mask allows visual monitoring of patient's breathing while the soft inner mask creates an improved facial seal. The low profile of ClearView™ Nasal Masks expand clinical field of view. These nasal masks are single-use, minimizing cross-contamination, and are compatible with other scavenging circuits, including Accutron™ PIP+™ Scavenging Circuits.



Accutron™ ClearView™ Nasal Masks, Adult <i>12 per box</i>	
Outlaw Orange	33035-10
Birthday Bubblegum	33035-12
French Vanilla	33035-14
Fresh Mint	33035-16
Unscented	33035-9

Accutron™ ClearView™ Nasal Masks, Large Adult <i>12 per box</i>	
Outlaw Orange	33034-10
French Vanilla	33034-14
Fresh Mint	33034-16
Unscented	33034-9



Accutron™ ClearView™ Nasal Masks, Pediatric <i>12 per box</i>	
Outlaw Orange	33037-10
Sassy Strawberry	33037-11
Birthday Bubblegum	33037-12
Groovy Grape	33037-17
Unscented	33037-9



Accutron™ Axess™ Nasal Masks

Accutron™ Axess™ Nasal Masks, our lowest profile design, provide unencumbered access to the oral cavity. These nasal masks fits snugly without tape or uncomfortable tubes protruding into the patient's nostril. Accutron™ Single-use Axess™ Nasal Masks are available in scented and unscented options.



Accutron™ Axess™ Low Profile Nasal Masks, Large *24 per box*

Birthday Bubblegum	53034-12
Fresh Mint	53034-16
Unscented	53034-9

Accutron™ Axess™ Low Profile Nasal Masks, Medium *24 per box*

Birthday Bubblegum	53035-12
Fresh Mint	53035-16
Unscented	53035-9

Accutron™ Axess™ Low Profile Nasal Masks, Small *24 per box*

Birthday Bubblegum	53037-12
Fresh Mint	53037-16
Unscented	53037-9



Accutron™ PIP+™ Nasal Masks

Single-use Accutron™ PIP+™ Nasal Masks provide patients with reliable and comfortable nitrous oxide/oxygen delivery and minimize cross-contamination; saving staff time. Scented and unscented Accutron™ PIP+™ Nasal Mask options come in bright colors and three sizes.



Learn more about all our
[Accutron™ PIP+™ Nasal Masks](#)

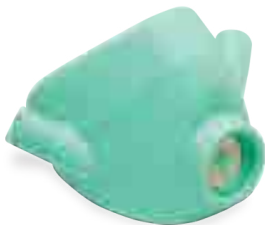

Accutron™ PIP+™ Single Use Nasal Masks, Large
24 per box

French Vanilla	33015-14
Perfect Peach	33015-15
Fresh Mint	33015-16
Variety Pack 3 (Mint, Peach, Vanilla)	33015-3
Unscented	33015-9



Accutron™ PIP+™ Single Use Nasal Masks, Medium <i>24 per box</i>	
Variety Pack 1 (Orange, Strawberry, Bubblegum)	33016-1
Variety Pack 2 (Pina Colada, Vanilla, Orange)	33016-2
Variety Pack 3 (Mint, Peach, Vanilla)	33016-3
Outlaw Orange	33016-10
Sassy Strawberry	33016-11
Birthday Bubblegum	33016-12
Pina Colada	33016-13
French Vanilla	33016-14
Perfect Peach	33016-15
Fresh Mint	33016-16
Unscented	33016-9

Accutron™ PIP+™ Single Use Nasal Masks, Small <i>24 per box</i>	
Variety Pack 1 (Orange, Strawberry, Bubblegum)	33017-1
Outlaw Orange	33017-10
Sassy Strawberry	33017-11
Birthday Bubblegum	33017-12
Groovy Grape	33017-17
Unscented	33017-9

Nasal Masks

Accutron™ Multi-Use Nasal Masks

The multi-use Accutron™ PIP+™ Nasal Masks feature the same design as the single-use and come in small, medium and large options.



Accutron™ Multi-Use Masks <i>1 per box</i>	
Small	33018
Medium	33019
Large	33020



Capnography Adaptors and Bundles

For measuring patients' end-tidal CO₂, our capnography adaptors attach between the nasal mask and scavenging circuit with a female Luer-Lok® port providing a secure connection to the capnography monitor's sample line. Capnography sampling takes place within the nasal mask and directly measures the patient's exhalations at the source. These single-use capnography adaptors connect to either side of the nasal mask for additional flexibility. Sold separately for both Axess™ Nasal Masks and ClearView™ Nasal Masks and Circuits, we also offer bundled options with both adaptors and nasal masks.



Accutron™ ClearView™ Capnography Adaptors 43055

12 per box



Accutron™ Axess™ Capnography Adaptors 53055

24 per box



Accutron™ ClearView™ Nasal Masks with Capnography Adaptors, Adult

12 sets per box

Outlaw Orange	33035-10-CAP
Birthday Bubblegum	33035-12-CAP
French Vanilla	33035-14-CAP
Fresh Mint	33035-16-CAP
Unscented	33035-9-CAP

Accutron™ ClearView™ Nasal Masks with Capnography Adaptors, Large Adult

12 sets per box

Outlaw Orange	33034-10-CAP
French Vanilla	33034-14-CAP
Fresh Mint	33034-16-CAP
Unscented	33034-9-CAP

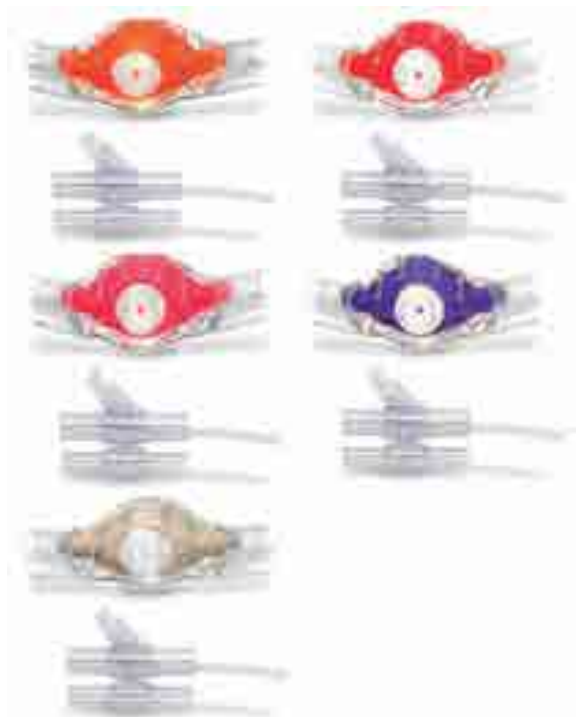

Accutron™ ClearView™ Nasal Masks with Capnography Adaptors, Pediatric

12 sets per box

Outlaw Orange	33037-10-CAP
Sassy Strawberry	33037-11-CAP
Birthday Bubblegum	33037-12-CAP
Groovy Grape	33037-17-CAP
Unscented	33037-9-CAP

Nasal Masks

Accutron™ ClearView™ Scavenging Circuits	E302
Accutron™ Axess™ Scavenging Circuits	E303
Accutron™ PIP+™ Scavenging Circuits	E304
PIP+™ Adaptors	E305

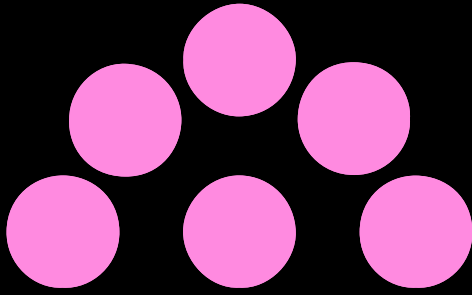

Scavenging Circuits

Scavenging is an important part of nitrous oxide/oxygen sedation since it carries the mixed gas to the patient, before being delivered through the nasal mask. Our Scavenging Circuits are sterilizable to meet current safety guidelines, and are available in a variety of configurations to suit your needs.



Learn more about all our
Scavenging Circuit products.



Accutron™ ClearView™ Scavenging Circuits

Accutron™ ClearView™ Scavenging Circuits are sterilizable and x-ray compatible. These products meet NIOSH and ADA flow rate recommendations and fit most brands of flowmeters.



**Accutron™ ClearView™ Scavenging Circuit II 43003
for Standard Bag Tee**

Includes: Scavenging Circuit with Vacuum Control Valve, Corrugated Tube and Reservoir Bag

**Accutron™ ClearView™ Scavenging Circuit I 43005
for Standard Bag Tee**

Includes: Scavenging Circuit with Vacuum Control Valve

**Accutron™ ClearView™ Scavenging Circuit I 43006
for RFS™ Remote Flow System & Accu-Vac™
Vacuum Controllers**

Includes: Scavenging Circuit and sampling of Accutron™ ClearView™ Single-use Nasal Masks

**Accutron™ ClearView™ Scavenging Circuit II 43004
for RFS™ Remote Flow System & Accu-Vac™
Vacuum Controllers**

Includes: Scavenging Circuit, Corrugated Tube and Reservoir Bag, as well as a sampling of Accutron™ ClearView™ Single-use Nasal Masks

**Accutron™ ClearView™ Scavenging Circuit 43009
for Reprocessing**

The reprocessable component of the Accutron™ ClearView™ Scavenging Circuit, so you can keep extra on hand to sterilize between each patient.

Matrx® to ClearView™ Adaptor 35360

Has spiral, white tubing.

**Accutron™
Axess™
Scavenging
Circuits**

Accutron™ Axess™ Scavenging Circuits are steam-sterilizable, making them an environmentally friendly and cost-effective solution for your practice. These slender, lightweight circuits are more comfortable for patients and allow unobstructed access for clinician. Accutron™ Axess™ Scavenging Circuits minimize drag and pull, so nasal masks stay in place.

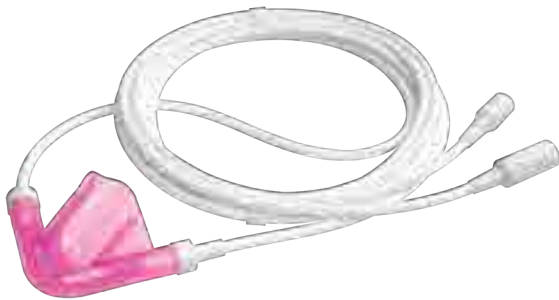

Accutron™ Axess™ Scavenging Circuit for In-line Vacuum Controller **52005**

Includes 6-foot long low profile scavenging circuit with In-line vacuum controller, complimentary low profile nasal mask assortment, adaptors for connecting most non-Accutron vacuum controllers, instructions for use and reprocessing.

Accutron™ Axess™ Scavenging Circuit for RFS™ (Remote Flow System) and Accu-Vac™ Vacuum Controller **52006**

Includes 6-foot long low profile scavenging circuit (to be used with RFS and Accu-Vac™ Vacuum Controllers – not provided), complimentary low profile nasal mask assortment, adaptors for connecting most non-Accutron vacuum controllers, instructions for use and reprocessing.

**Accutron™ PIP+™
Scavenging
Circuits**

Accutron™ PIP+™ Scavenging Circuits are sterilizable and x-ray compatible. These Scavenging Circuits meet NIOSH and ADA flow rate recommendations.



Accutron™ PIP+™ Scavenging Circuit I for RFS™ (Remote Flow Systems) & Accu-Vac™ Vacuum Controller **33008**

Includes: Scavenging Circuit and complimentary Accutron™ PIP+™ Single-Use Nasal Masks

Accutron™ PIP+™ Scavenging Circuit II for RFS™ (Remote Flow Systems) & Accu-Vac™ Vacuum Controller **32009**

Includes: Scavenging Circuit, Corrugated Tube, Reservoir Bag, and complimentary Accutron™ PIP+™ Single-Use Nasal Masks

Accutron™ PIP+™ Scavenging Circuit II for Standard Bag Tee **32007**

Includes: Scavenging Circuit with Vacuum Control Valve, Corrugated Tube, Reservoir Bag and a complimentary sampling of single-use Accutron™ PIP+™ Nasal Masks (nasal masks included are representative of all sizes available)

Accutron™ PIP+™ Scavenging Circuit I for Standard Bag Tee **33010**

Includes: Scavenging Circuit with Vacuum Control Valve and a complimentary sampling of single-use Accutron™ PIP+™ Nasal Masks

Accutron™ PIP+™ Scavenging Circuit for Reprocessing **33009**

The reprocessable component of the Accutron™ PIP+™ Scavenging Circuit, so you can keep extra on hand to sterilize between each patient.





PIP+™ Adaptors

Convert your current scavenging circuit into a PIP+™ Scavenging Circuit with:

Porter® Brown to PIP+™ Adaptor **35000**

Has four tubes – two ports on each side, mask within mask bearing the name "Brown."

Porter® Clean Air to PIP+™ Adaptor **35100**

Has tube inside tube and wings or vacuum sweeps to draw off excess gas.

Matrx® (Ohmeda) to PIP+™ Adaptor **35325**

Has spiral, white tubing.

Matrx® to PIP+™ Adaptor **35350**

Has one smooth, white tube on each side.

McKesson to PIP+™ Adaptor **35400**

Has clear mask and one tube on each side.

ClearView™ to PIP+™ Adaptor **35500**

Has four tubes - two ports on each side, colored and scented mask within clear outer mask.



Note: some of the devices, products, and/or programs advertised may not be licensed for sale outside the United States. Contact your local sales or customer care representative for availability details. For full product warranty details, please visit [HuFriedyGroup.com/services/warranties](https://www.hufriedygroup.com/services/warranties)

The contents of this catalog including, but not limited to, all text, photographs and graphics, are the sole and exclusive property of Hu-Friedy Mfg. Co., LLC its affiliates or related companies and may not be copied, reproduced or distributed without prior written permission.

Hu-Friedy Mfg. Co., LLC, 1666 E. Touhy Ave., Des Plaines, IL 60018 | [HuFriedyGroup.com](https://www.hufriedygroup.com)

All company and product names are trademarks of Hu-Friedy Mfg. Co., LLC its affiliates or related companies, unless otherwise noted. Hygoformic® is a registered trademark of J.H. ORSING AB. VELCRO® is a registered trademark of Velcro IP Holdings LLC. Rinn® and Eezee-Grip® are registered trademarks of Dentsply Sirona Inc. Uni-Grip® is a registered trademark of Uni-Grip Inc.



Operator Supplies

Operator Supplies are the items you need to perfectly complement your HuFriedyGroup instrumentation, instrument management and infection control products. With saliva ejectors and HVE tips, barriers, covers & towels, cotton/non-woven products, cups and more, we can help you round out any treatment with the highest quality treatment accessories you will use each and every day.

Cotton & Non-Wovens	F101
Cups	F201
Evacuation Products	F301
Operator Protection	F401
Patient Towels & Bibs	F501
Tongue Depressors	F601
X-Ray Products	F701

Sponges	F102
Premium™ All-Gauze Sponges	F102
Crosstex™ Ultra-Pure™ Non-Woven Sponges	F103
Cotton-Filled Sponges	F103
Premium™ Non-Woven Sponges	F104
Ultra-Gauze™ Non-Woven Sponges	F104
Cotton Rolls & Applicators	F105
Dispensers	F106

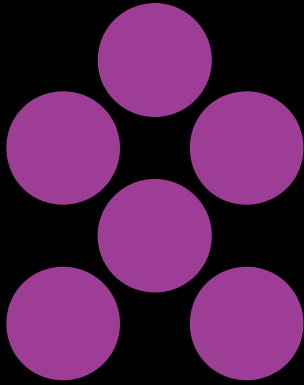

Cotton & Non-Wovens

Cotton rolls, applicators, sponges and gauze, available in various gram weights and sizes.



Sponges

Our lineup of All-Gauze, Non-Woven, and Cotton-Filled sponges provide you with options that fit your procedure.



Learn more about our [Sponges](#).

Premium™ All-Gauze Sponges

Crosstex™ Premium™ All-Gauze, Non-Sterile Sponges are made from USP 100% gauze. Highly absorbent and available in 8-ply, 12-ply or 16-ply.



Cotton & Non-Wovens

Crosstex™ Premium™ All-Gauze Sponges	
2" x 2" (5.1 cm x 5.1 cm)	
8-ply – 5000 per case; 200 per sleeve	ENC2
12-ply – 8000 per case; 200 per sleeve	ENC212
3" x 3" (7.6 cm x 7.6 cm)	
12-ply – 4000 per case; 200 per sleeve	ENC312
8-ply – 4000 per case; 200 per sleeve	ENC38
4" x 4" (10.2 cm x 10.2 cm)	
12-ply – 2000 per case; 200 per sleeve	ENC412
16-ply – 2000 per case; 200 per sleeve	ENC416
8-ply – 4000 per case; 200 per sleeve	ENC48



Crosstex™ Ultra-Pure™ Non-Woven Sponges

4-ply, Non-Sterile Crosstex™ Ultra-Pure™ Non-Woven Sponges are biodegradable – a great way to reduce your carbon footprint. Ideal for placement on incision/extraction sites as it easily releases, for increased patient comfort and lint-free – extremely soft, smooth, strong and will not adhere to instruments.



Crosstex™ UltraPure™ Non-Woven Sponges, 4-Ply 2" x 2" (5.1 cm x 5.1 cm)

45 g – 5000 per case; 200 per sleeve **ENC100**

4" x 4" (10.2 cm x 10.2 cm)

40 g – 2000 per case; 200 per sleeve **ENC4100**

Cotton-Filled Sponges

Cotton-Filled Sponges are made from USP cotton gauze. Pure, virgin white cotton with 100% cotton-fiber filling and highly absorbent.



Crosstex™ Premium™ Cotton-Filled Sponges, Exodontia 2" x 2" (5.1 cm x 5.1 cm)

Non-sterile, 125 g **ENCC**
20,000 per case; 200 per sleeve

Sterile, 125 g **ESCC**
20,000 per case; 200 per sleeve

3" x 3" (7.6 cm x 7.6 cm)

125 g – 4000 per case; 200 per sleeve **ENCC3**

4" x 4" (10.2 cm x 10.2 cm)

125 g – 2000 per case; 200 per sleeve **ENCC4**



Premium™ Non-Woven Sponges

4-Ply, Non-Sterile, Non-Woven Sponges are a unique rayon/polyester blend. Provides maximum absorbency and less adhesion to wounds for faster healing.



Crosstex™ Non-Woven Sponges	
2" x 2" (5.1 cm x 5.1 cm)	
50 g – 4000/case; 200/sleeve	ENCNW4K
50 g – 20,000/case; 200/sleeve	ENCNW
3" x 3" (7.6 cm x 7.6 cm)	
40 g – 4000 per case; 200 per sleeve	ENC3NW
4" x 4" (10.2 cm x 10.2 cm)	
40 g – 2000 per case; 200 per sleeve	ENC4NW

Ultra-Gauze™ Non-Woven Sponges

4-Ply, Non-Sterile Ultra-Gauze™ Non-Woven Sponges are more absorbent than traditional sponges. Exclusive 70/30 polyester formed non-woven material replicates the look of woven gauze. Ideal for placement on incision/ extraction sites as it easily releases for increased patient comfort.



Crosstex™ Ultra Gauze Non-Woven Sponges	
4-Ply, Non-Sterile, 40 g	
2" x 2" (5.1 cm x 5.1 cm)	
5000 per case; 200 per sleeve	ENCNWU
8000/case; 200/sleeve	ENCNWUB
3" x 3" (7.6 cm x 7.6 cm)	
4000 per case; 200 per sleeve	ENC3NWU
4" x 4" (10.2 cm x 10.2 cm)	
2000 per case; 200 per sleeve	ENC4NWU



Cotton Rolls & Applicators

We offer highly absorbent Cotton Rolls that will not adhere to mucous membrane. Cotton Tipped Applicators are also available with 100% cotton tips and extremely tight buds that minimize linting.



Learn more about our [Cotton Rolls and Applicators](#).



Crosstex™ Premium™ Cotton Rolls	
2000 per box	
1.5" x 0.375" (3.8 cm x 1 cm)	DNC



Premium™ Cotton Tipped Applicators	
1000 per box	
3" (7.6 cm)	H3C
6" (15.2 cm)	H6C

Cotton & Non-Wovens



Dispensers

Our Dispensers have a flip-up top for easy loading and hold up to 50 cotton rolls. The slide out drawer dispenses up to 4 rolls. Dispensers come with a non-skid base for easy dispensing.



Deluxe Cotton Roll Dispenser

4" x 4" x 2" (10.2 cm x 8.4 cm x 5.1 cm)

Holds up to 50 cotton rolls

Blue **PDCBL**

White **PDCWH**

Turn Four-Handed Dentistry Into Two-Handed Dentistry

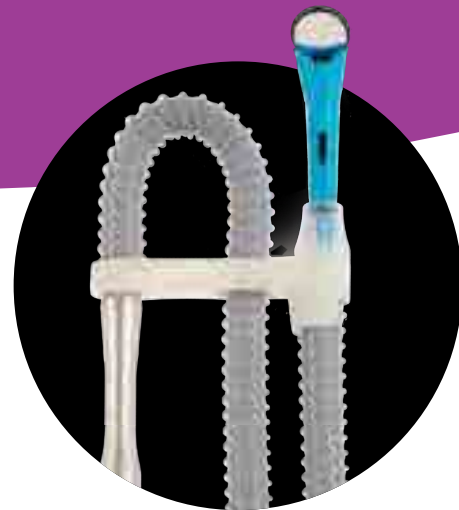

Our HVE Mirror Connect* transforms standard four-handed dentistry into comfortably streamlined two-handed dentistry. Designed to integrate our #5 double-sided mouth mirrors, the single-use HVE Mirror Connect combines the market-leading visibility of our mirrors* and a unique high-volume evacuator with a lacrosse-style mouth that optimizes suction.

Also Available HVE Mirror Connect Kit

The HVE Mirror Connect Kit includes everything you'll need for Best in Practice high-volume evacuation. This easy-to-assemble kit combines the HVE Mirror Connect with a lightweight tubing system and swivel functionality, which allows for effortless rotation.



[Request Your Sample](#)

*#5 Mouth Mirror Sold Separately

 **HuFriedyGroup**
The Best In Practice

Medicine/Mixing Cups

F202

Plastic Cups & Dispenser

F203

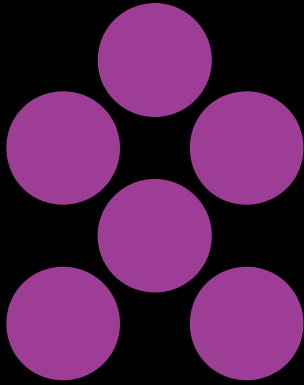

Cups

Our variety of plastic cups include a unique embossing for greater strength and easy dispensing. Our offering includes a variety of color options.



Medicine/Mixing Cups

Medicine/Mixing Cups feature fluid ounce, dram, cc, mL, teaspoon and tablespoon units with clearly marked graduations. Convenient for dispensing or mixing, these mixing cups' unbreakable polypropylene material can be squeezed to form a pour spout.



Medicine/Mixing Cups

100 per sleeve

Clear - 1 fl oz (30 mL)

CX1



Plastic Cups & Dispenser

Our Plastic Cups are uniquely embossed for greater strength and easy dispensing. Double-rolled lips provide easy separation and enhanced patient comfort. Our Cup Dispenser sports a contemporary design that fits the décor of every office and dispenses fifty 5-ounce/148 mL plastic and wax-coated paper cups—one cup at a time.



Plastic Cups

Our Plastic Cups include unique embossing for greater strength and easy dispensing. Double-rolled lip enables easy separation and enhanced patient comfort. Plastic Cups are thick-walled for added strength and patient safety. 5 fl oz (148 mL), 1000 per case

Beige	CXBG
Blue	CXBL
Dusty Rose	CXDR
Green	CXGR
Lavender	CXLV
Peach	CXPE
Silver Grey	CXSI
White	CXWH
Yellow	CXYE

5 fl oz (148 mL), 2500 per case

Clear	CXCL
-------	-------------



Plastic Cup Dispenser

This Dispenser sports a contemporary design that fits the décor of every office. Dispenses 5-ounce/148 mL plastic and wax-coated paper cups—one cup at a time. Includes self-adhesive strips for easy wall mounting. Holds 50 cups

White base with clear top	PCC
---------------------------	------------

High Volume Evacuators (HVE) F302

HVE Mirror Connect	F302
MaxVac Plus Combo-Tip™ Evacuators	F303
Slotted Tips	F303
Non-Vented Tips	F303

Saliva Ejectors F304

Safe-Flo™ Plus Saliva Ejectors	F304
Safe-Flo™ Saliva Ejectors & Valves	F304
Safe-Flo™ Saliva Ejector Valve	F305
Safe-Flo™ High Volume Evacuation Valve	F305
Safe-Flo™ Adapter Valve	F305
Comfort Plus™ Premium Saliva Ejectors	F305
Premium™ Saliva Ejectors	F306
Hygoformic® Saliva Ejectors	F306

Air & Water Syringe Tips F307

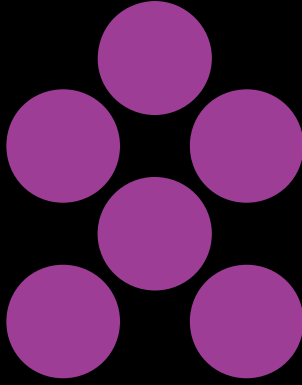

Evacuation Products

Aerosol mitigation is more important than ever.

Our wide variety of HVE Tips and Saliva Ejectors can help. For added protection, check out our Safe-Flo™ Saliva Ejectors and Valves to control backflow.



High Volume Evacuators (HVE)

Our variety of high-volume evacuators draw a large volume of air over a period of time and are fitted onto an evacuation system.



Learn more about our [High Volume Evacuators](#).

HVE Mirror Connect

The HVE Mirror Connect transforms standard four-handed dentistry into comfortably streamlined two-handed dentistry. Designed to complement our #5 double-sided mouth mirrors, the HVE Mirror Connect combines the market-leading visibility of our mirrors* and a unique high-volume evacuator with a lacrosse-style mouth that optimize suction.



HVE Mirror Connect

50 per bag

Blue

HVEMC



HVE Mirror Connect Kit

Includes HVE Mirror Connects, #5 Black Line Mirror and Tubing Kit

Blue

HVEMCKIT



MaxVac Plus Combo-Tip™ Evacuators

Manufactured from high density polyethylene. MaxVac Plus Combo-Tip™ Evacuators are two tips in one – vented on one end/non-vented on the other. Unique “S” tip design eliminates sharp edges enhancing patient safety and comfort. Stiff, firm construction allows for cheek retraction.



HVE Combo-Tip™ Evacuators 100 per bag

White	ZET
-------	------------

MaxVac Plus with Color™ Combo-Tip™ Evacuators 100 per bag

Blue	ZETMVBL
Green	ZETMVGR
Purple	ZETMLV
Pink	ZETMVPK
Yellow	ZETMVE

1000 per case (2 bags/color per case)

Assorted	ZETMVP
----------	---------------

Slotted Tips

Slotted Tip design increases suction. Manufactured from high density polyethylene, their stiff, firm construction allows for cheek retraction.

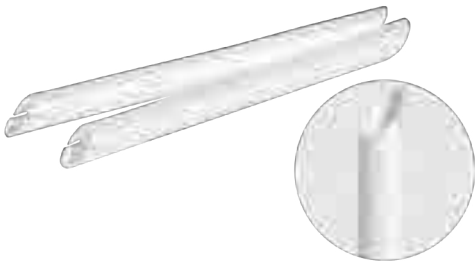

Slotted HVE Tips 50 per bag

White	ZES50
-------	--------------

Non-Vented Tips

Similar to the HVE Combo-Tip™ Evacuators, however both ends are non-vented. Their unique “S” tip design eliminates sharp edges enhancing patient safety and comfort.

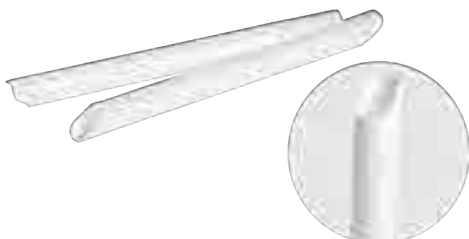

HVE Tips - Non-Vented Tip 50 per bag

White	ZETNV
-------	--------------



Our Saliva Ejectors effectively and efficiently remove saliva and pooling water during patient care.



Learn more about our [Saliva Ejectors](#).

Safe-Flo™ Plus Saliva Ejectors

Combines the enhanced comfort of our Comfort Plus™ Saliva Ejector with the peace of mind of our Safe-Flo™ backflow prevention valve. Available in unscented, mint, and bubblegum scents to improve patient experience.

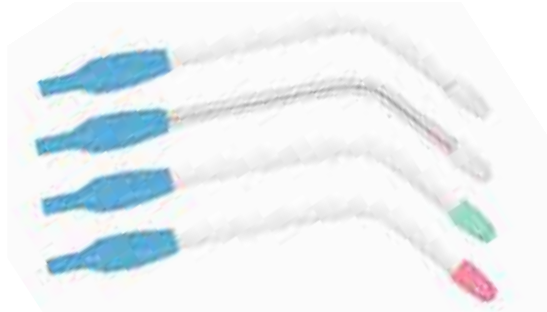

Safe-Flo™ Plus Saliva Ejectors 100 per bag	
White/White, Unscented	M1002WHWH
Clear/White, Unscented	M1003CLWH
White/Green, Mint scented	M1004WHGR
White/Pink, Bubblegum scented	M1005WHPK

Evacuation Products

Safe-Flo™ Saliva Ejectors & Valves

Single-use Safe-Flo™ Saliva Ejectors and Valves provide a physical barrier to prevent backflow as described in the warning on saliva ejectors from Centers for Disease Control and Prevention (CDC)*. The unique one-way valve closes when the suction is stopped or restricted to prevent residual fluids from retracting into a patient's mouth.

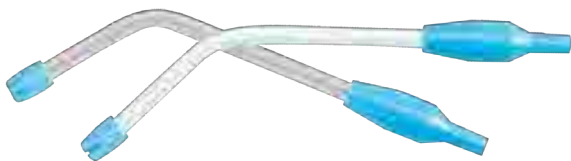

Safe-Flo™ Saliva Ejectors 100 per bag	
White/Blue	M1000WHBU
Clear/Blue	M1001CLBU

*www.cdc.gov/oralhealth/infectioncontrol/faqs/saliva.html



Safe-Flo™ Saliva Ejector Valve

For backflow prevention in low-volume evacuation lines with your preferred saliva ejector.



Safe-Flo™ SE Valve

100 per bag

Blue

M1010SUSE

Safe-Flo™ High Volume Evacuation Valve

For backflow prevention in high-volume evacuation (HVE) lines with your preferred HVE tip.



Safe-Flo™ HVE Valve

100 per bag

Gray

M1030HVSE

Safe-Flo™ Adapter Valve

Allows use of the HVE line with your preferred saliva ejector for backflow prevention. Provides a higher level of aspiration to the saliva ejector.



Safe-Flo™ Adapter

For using a saliva ejector on a high volume line.

50 per bag

Blue/Gray

M1020ADAP

Comfort Plus™ Premium Saliva Ejectors

Comfort Plus™ Saliva Ejectors are the kinder, gentler saliva ejector that takes in fluid, not tissue. With a smooth, rounded tip designed to enhance patient comfort, it will not grab mucosal tissue. Facilitates uninterrupted fluid and light debris removal. Optimizes fluid removal as tip design prevents tissue from blocking suction.



Comfort Plus™ Premium Saliva Ejectors

100 per bag

Clear/White

ZCWCP

White/Green, Mint scented

ZWGCPM

White/Pink, Bubblegum scented

ZWPCPBG

White/White

ZWWCP



Premium™ Saliva Ejectors

These saliva ejectors hold shape when formed as result of proprietary manufacturing process. Soft, non-removable tips are bonded to the tube for maximum patient safety. Provides optimal suction and sports a matte finish that eliminates glare.



Premium™ Saliva Ejectors	
100 per bag	
Frosted/Blue	ZCB
Frosted/White	ZCW
Pink/Pink	ZPP
White/White	ZWW
Assorted, Multi-color	ZCMC

Hygoformic® Saliva Ejectors

Hygoformic® Saliva Ejectors are combination saliva ejectors and tongue retractors. Unique coil design is adjustable for maximum patient comfort and smooth edges eliminate irritation – ideal for patients with sensitive tissue. Environmentally friendly.



Hygoformic® Saliva Ejectors	
100 per bag	
Light Green	ZFF
100 per bag	
Adapters (white)	ZFFAD-100



Air & Water Syringe Tips

Sparkle™ Air/Water Syringe Tips feature a Quad Core™ air channel to ensure complete air and water separation. The five translucent colors allow for visualization of water flow/blockage, and no adapter is required for easy and secure installation. A locking groove ensures tip is securely installed and a beveled edge provides increased patient comfort and safety. Single-use eliminates risk of cross-contamination and cleaning of syringe between patients.

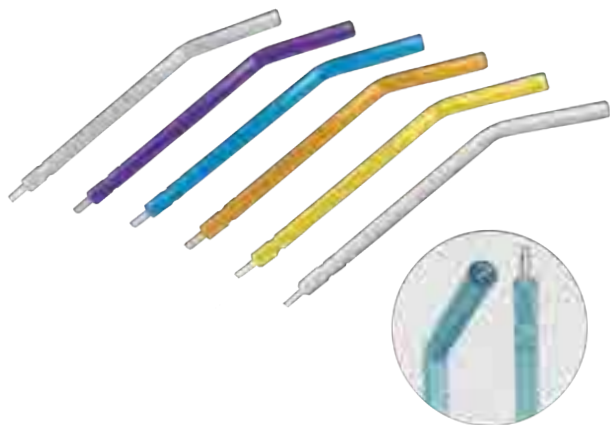

Sparkle™ Air Water Syringe Tips, Disposable 250 per bag

Clear	BCSAWSCL
White	BCSAWSWH
Assorted (Blue, Purple, Yellow, Amber)	BCSAWS

1500 per bag

Bulk Assorted (Blue, Purple, Yellow, Amber)	BCSAWSB
---	-------------------------

Barriers	F402
Barrier Film	F402
Chair Sleeves	F403
Light Sleeves	F403
Syringe Sleeves	F404
Tray Sleeves	F404
X-Ray Sleeves	F404
Covers	F405
Headrest Covers	F405
Pillow Cases	F406
Bracket Tray Covers	F407
Lab Transport Bags	F408

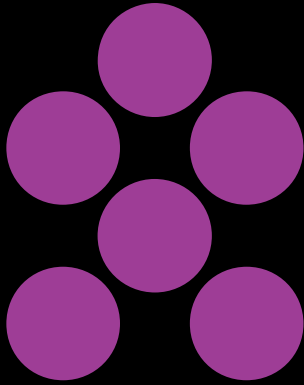

Operator Protection

Operator Protection products are necessary to help you maintain infection control protocols. Use our barrier products and covers to protect a wide range of surfaces and lab transport bags to meet OSHA requirements.



Barriers

We offer a wide variety of barrier sleeves and films for virtually any surface, including chairs, trays, and lights.



Learn more about our [Barriers](#).

Barrier Film

Barrier Films have a unique 3/16" (0.476 cm) non-adhesive finger-lift edge that allows for quick, easy placement/removal. Their light tack adhesive easily attaches to surfaces without leaving residue. Barrier Films are ideal for areas that are hard-to-reach, clean or disinfect.

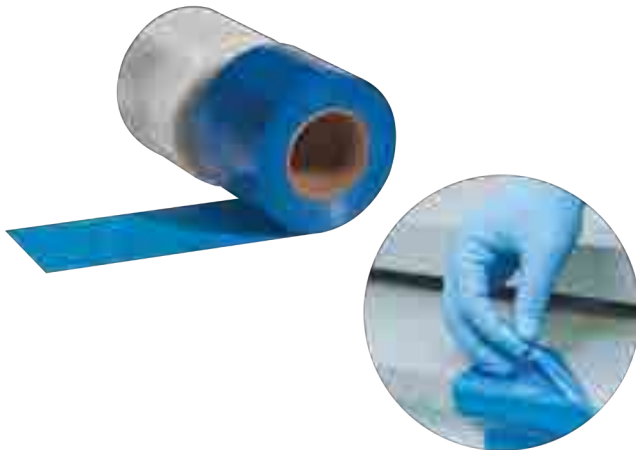

Barrier Film with Finger-Lift Edge
1200 sheets per roll

Blue - 4" x 6" (10.2 cm x 15.2 cm)	BFBL
Clear - 4" x 6" (10.2 cm x 15.2 cm)	BFCL



Chair Sleeves

Our Chair Sleeves are universal, clear plastic sleeves for patient chairs. Their half-sleeve design covers chair back and side chair controls. Quick, easy, and economical, our Chair Sleeves reduce risk of cross-contamination for airborne aerosols and body fluids.



Chair Sleeves

225 sleeves per roll

Clear - 27.5" x 24" (69.9 cm x 61 cm)

BCCS

Light Sleeves

Light Sleeves are clear plastic sleeves for T-style light handles. White indicator arrows quickly identify die-cut location. Quick, easy, and economical, Light Sleeves will not come off during use.



T-Handle Light Sleeves

500 per box

4" x 5.75" (10.2 cm x 14.6 cm)

BCLST



Syringe Sleeves

These clear plastic Syringe Sleeves easily fit over 3-way syringe, high/low-speed handpieces and/or air abrasion handpieces. They reduce risks of cross-contamination for airborne aerosols and body fluids. Available in 2 configurations: without opening and with opening.



Syringe Sleeves	
500 per box	
Without Opening (Clear) 2.5" x 10" (6.4 cm x 25.4 cm)	BCSS
With Opening (Blue) 2.5" x 10" (6.4 cm x 25.4 cm)	BCSSBO
With Opening (Clear) 2.5" x 10" (6.4 cm x 25.4 cm)	BCSSO

Tray Sleeves

These clear plastic Tray Sleeves' secure fit end-fold provides maximum protection and reduces the risk of cross-contamination from airborne aerosols and body fluids. Available in 4 convenient sizes.



Tray Sleeves	
500 per box	
Clear, ADEC/Size B-Ritter 10.5" x 14" (26.7 cm x 35.6 cm)	BCTS1014
Clear, Chayes/Size B Ritter 11.625" x 14.5" (29.5 cm x 36.8 cm)	BCTS1114
Clear, Midwest/Weber 11.5" x 16" (29.2 cm x 40.6 cm)	BCTS1116
Clear, Mini Trays 7.5" x 10.5" (19.1 cm x 26.7 cm)	BCTS710

X-Ray Sleeves

Universal clear plastic X-Ray Sleeves fit most x-ray heads and reduce risk of cross-contamination for airborne aerosols and body fluids. X-Ray Sleeves are quick, easy, and economical and will not adversely affect quality of the x-ray image.



X-Ray Sleeves	
250 per box	
Clear - 15" x 26" (38.1 cm x 66 cm)	BCXR



Covers

Our Covers are manufactured from unique, heavy weight paper and impede flow of moisture, minimizing seep-through.



Learn more about our [Covers](#).

Headrest Covers

Our Headrest Cover lineup includes Non-Woven, Plastic, and Polycoated options that all come in multiple sizes. Headrest Covers protect against cross-contamination and add patient comfort.



Crosstex™ Non-Woven Headrest Covers 500 per case	
Standard	
White - 10" x 10" (25.4 cm x 25.4 cm)	LOC
Lavender - 10" x 10" (25.4 cm x 25.4 cm)	LOCL
XL	
White - 10" x 13" (25.4 cm x 33 cm)	L3C



Crosstex™ Plastic Headrest Covers 250 per dispenser box	
Regular	
Clear - 9.5" x 11" (24.1 cm x 27.9 cm)	LOCP
White - 9.5" x 11" (24.1 cm x 27.9 cm)	LOCPW
Jumbo	
Clear - 9.5" x 14" (24.1 cm x 36.6 cm)	L3CP
White - 9.5" x 14" (24.1 cm x 36.6 cm)	L3CPW



Polycoated Headrest Covers

500 per case

Standard - 10" x 10" (25.4 cm x 25.4 cm)

Blue	LOBL
Dusty Rose	LODR
Green	LOGR
Lavender	LOLV
White	LOWH

Extra Large - 10" x 13" (25.4 cm x 33.0 cm)

Blue	L3BL
Dusty Rose	L3DR
Green	L3GR
Lavender	L3LV
White	L3WH

Pillow Cases

Our strong and absorbent Pillow Cases' soft facial tissue combine with poly to provide positive fluid barrier for maximum protection from cross-contamination.



Pillow Cases

100 per box

21" x 30" (53.3 cm x 76.2 cm)

PC2130



Bracket Tray Covers

Bracket Tray Covers are manufactured from a unique, heavy weight paper and impedes the flow of moisture, minimizing seep-through on tray. Offered in a range of colors to coordinate with other Operator Supplies. Liquid-Proof Tray Covers are available in two sizes and offered in white only. They are dual use: poly-side down provides positive moisture barrier, while poly-side up provides ideal surface for quick mixing.

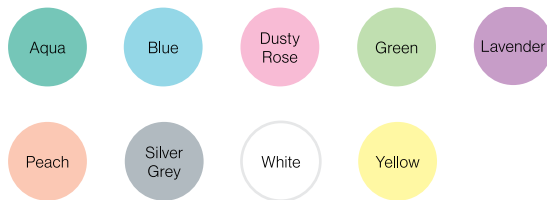

Bracket Tray Covers

1000 per carton

Size A, Weber/Chayes - 9.5" x 12.25" (24.1 cm x 31.1 cm)

Blue **FABL**

White **FAWH**

Size B, Ritter - 8.5" x 12.25" (21.6 cm x 31.1 cm)

Aqua **FBAQ**

Blue **FBBL**

Dusty Rose **FBDR**

Green **FBGR**

Lavender **FBLV**

Peach **FBPE**

Silver Grey **FBSI**

White **FBWH**

Yellow **FBYE**

Size C, Weber Hi-Lo - 11" x 17.5" (27.9 cm x 44.5 cm)

Blue **FCBL**

White **FCWHBX**

Size D, SS White #20 - 10.25" x 15.75" (26 cm x 40 cm)

Blue **FDBL**

White **FDWH**

Size E, Midwest - 9" x 13.5" (22.9 cm x 34.3 cm)

White **FEWH**

Size M, Mini - 5" x 8" (12.7 cm x 20.2 cm)

White **FMINI**

Liquid-Proof Bracket Tray Covers

500 per carton

Size B, Ritter - 8.5" x 12.25" (21.6 cm x 31 cm)

White **FBC**

Size F, Adec - 8.5" x 11" (21.6 cm x 27.9 cm)

White **FF**



Lab Transport Bags

Our Lab Transport Bags meet OSHA requirements and recommendation of NCCLS (National Committee for Clinical Laboratory Standards) for transport of medical specimens and/or dental lab cases. Convenient two-pouch system keeps Rx/lab slip separate from specimens/lab case as required by OSHA. The permanent adhesive closure does not contact gloved hands, and they are tamper-evident.



Learn more about our [Lab Transport Bags](#).



Lab Transport Bags
250 per box

6" x 10" (15.2 cm x 25.4 cm)

BAGS



“Small violations can have
big consequences.
What could I be missing?”

STAYING COMPLIANT IS MORE CRITICAL THAN EVER.

Managing infection prevention standards and guidelines is no easy task. The number of standards and guidelines outlined by organizations like the CDC, state dental boards and OSHA can be overwhelming, and everyone is held to a high level of accountability. To have an effective infection prevention program, staff members must be thoroughly trained and committed to following the right steps every time. Because there is no “good enough” — only compliant or noncompliant.

Change the way you look at infection prevention with the GreenLight Dental Compliance Center by Hu-Friedy. This exclusive, one-of-a-kind resource keeps all of your infection prevention guidelines and regulations conveniently housed in one portal. With GreenLight, you can easily assess, improve, and maintain compliance.



Get started on the path to increased compliance by visiting **GreenLightComplianceCenter.com**



GREENLIGHT
DENTAL COMPLIANCE CENTER™
by Hu-Friedy

Chain-Free Towels	F502
3-Ply Tissue with 1-Ply Poly	F503
2-Ply Tissue with 1-Ply Poly	F505
Extra Heavy Tissue with 1-Ply Poly	F506
2-Ply & 3-Ply Tissue	F507
Towel Dispenser	F508
Patient Barrier Aprons	F509

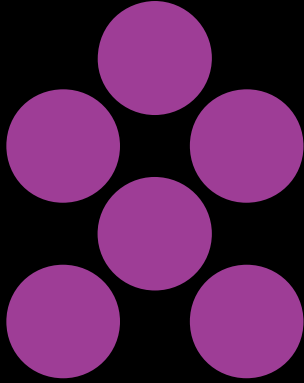

Patient Towels & Bibs

For over 60 years, we have been the benchmark of quality in patient towels, bibs, and liners. Our manufacturing process provides our unique embossing pattern, which allows moisture to flow horizontally across the towel, protecting patients' clothing. Our exclusive reinforced edge embossing design adds strength and durability where towel clips are placed. Our manufacturing process also bonds the layers of tissue securely together, eliminating separation of the layers.



Chain-Free Towels

Sani-Tab™ Chain-Free Patient Towels are the only chain-free patient towel with adhesive tabs eliminating the need for bib chains and clips. Sani-Tab™ Towels maximize infection control and patient comfort while saving time and money. Bib stays where placed to maximize coverage.



Learn more about our complete portfolio of [Patient Towels and Bibs](#).



Patient Towels & Bibs

Sani-Tab™ Chain-Free Patient Towels













Crosstex Fold/Horizontal Embossing
19" x 13" (48.3 cm x 33.0 cm)
400 per case

Blue, 2-ply	WEXBLT
Dusty Rose, 2-ply	WEXDRT
Lavender, 2-ply	WEXLVT
White, 2-ply	WEXWHT
Blue, 3-ply	WPXBLT
Dusty Rose, 3-ply	WPXDRT
White, 3-ply	WPXWHT



3-Ply Tissue with 1-Ply Poly



-  Aqua
-  Beige
-  Blue
-  Dusty Rose
-  Green
-  Happy Feet
-  Lavender
-  Peach
-  Silver Grey
-  Teddy Bear
-  White
-  Yellow

Polyback™ Towels	
Crosstex Fold/Horizontal Embossing 19" x 13" (48.3 cm x 33.0 cm) 500 per case	
Aqua	WPXAQ
Beige	WPXBG
Blue	WPXBL
Dusty Rose	WPXDR
Green	WPXGR
Happy Feet Print	WPXFP
Lavender	WPXLV
Peach	WPXPE
Silver Grey	WPXSI
Teddy Bear Print	WPXTB
White	WPXWH
Yellow	WPXYE

Poly-Gard™ Towels	
Crosstex Fold/Horizontal Embossing 19" x 16" (48.3 cm x 40.6 cm) 500 per case	
Blue	WGXBL
White	WGXWH



Poly-Gard™ Deluxe Towels	
Vantage Fold/Pebble Embossing 18" x 30" (45.7 cm x 76.2 cm) 300 per case	
Blue	W3D1930BL
White	W3D1930WH



3-Ply Tissue with 1-Ply Poly



Polyback™ Contour Bib Towels
18" x 22" (45.7 cm x 55.9 cm)
Vantage Fold/Pebble Embossing
400 per case

White	WERUEC
Blue	WERUECBL
Dusty Rose	WERUECDR
Green	WERUECGR



2-Ply Tissue with 1-Ply Poly

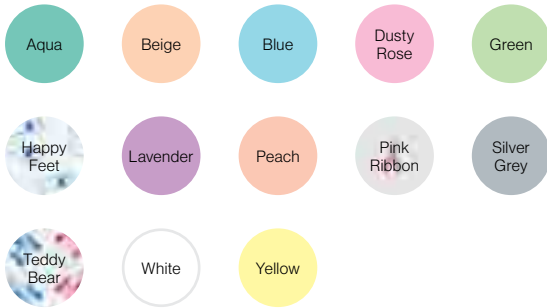

Econoback™ Patient Towels
 Crosstex Fold/Horizontal Embossing
 19" x 13" (48.3 cm x 33.0 cm)
 500 per case

Aqua	WEXAQ
Beige	WEXBG
Blue	WEXBL
Dusty Rose	WEXDR
Green	WEXGR
Happy Feet Print	WEXFP
Lavender	WEXLV
Peach	WEXPE
Pink Ribbon	WEXPP
Silver Grey	WEXSI
Teddy Bear Print	WEXTB
White	WEXWH
Yellow	WEXYE

Ultra-Gard™ Patient Towels
 Crosstex Fold/Horizontal Embossing
 19" x 16" (48.3 cm x 40.6 cm)
 500 per case

Blue	WUXBL
White	WUXWH
Yellow	WUXYE



Extra Heavy Tissue with 1-Ply Poly



Proback™ Patient Towels
Crosstex Fold/Horizontal Embossing
19" x 13" (48.3 cm x 33.0 cm)
500 per case

Aqua	WEPBAQ
Blue	WEPBBL
Dusty Rose	WEPBDR
Green	WEPBGR
Lavender	WEPBLV
Peach	WEPBPE
Silver	WEPBSI
White	WEPBWH
Yellow	WEPBYE

2-Ply & 3-Ply Tissue



Professional™ Thrift Towels, 2-Ply
 Crosstex Fold/Horizontal Embossing
 19" x 13" (48.3 cm x 33.0 cm)
 500 per case

Blue	WT5BL
White	WT5WH

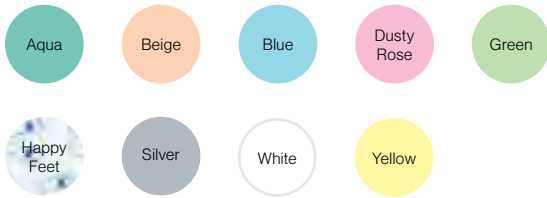

Professional™ Regular Towels, 3-Ply
 Crosstex Fold/Horizontal Embossing
 19" x 13" (48.3 cm x 33.0 cm)
 500 per case

Aqua	WTX AQ
Beige	WTX BG
Blue	WTX BL
Dusty Rose	WTX DR
Green	WTX GR
Happy Feet Print	WTX FP
Silver	WTX SI
White	WTX WH
Yellow	WTX YE



Towel Dispenser

Made from polished acrylic, this Towel Dispenser sits on a counter, shelf, or easily mounts to wall with supplied mounting kit. Accommodates folded towels up to 19" x 13" and holds approximately 50 towels.



Towel Dispenser

5" x 6" x 7" (12.7 cm x 15.2 cm x 17.7 cm)

PTC



Patient Barrier Aprons

Our Patient Barrier Aprons protect patients from liquids and are made in plastic and nylon materials, coming in three sizes. Aprons feature two alligator clips attached to the front of the neck band to hold a disposable patient towel/bib and a touch-tab Velcro® closure for fast and easy fastening.



Patient Barrier Aprons

Protects the patient from liquids
1 per bag

Waist length. Plastic & Nylon
27" x 30" (68.6 cm x 193.0 cm)

Blue/Nylon **NN3BL**

Blue/Plastic **NP3BL**

White/Plastic **NP3WH**

Knee length. Plastic & Nylon
27" x 44" (68.6 cm x 111.8 cm)

Blue/Nylon **NN4BL**

Blue/Plastic **NP4BL**

White/Plastic **NP4WH**

Ankle length. Plastic
36" x 54" (91.4 cm x 137.2 cm)

Blue/Plastic **NP5BL**

White/Plastic **NP5WH**

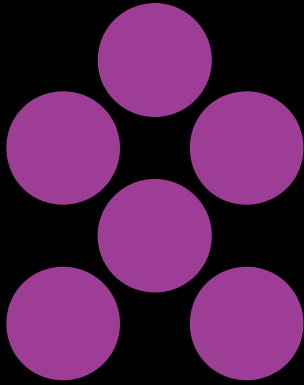

Tongue Depressors

Manufactured from medical grade, high quality, smooth and splinter-free wood, our Tongue Depressors' self-dispensing boxes are quick, easy, and economical. Tongue Depressors are standard in size and available sterile or non-sterile.



Tongue Depressors



Tongue Depressors 6" (15.2 cm)

Non-Sterile, 500 per box

IC

Sterile, 100 per box

ICS

SHARING IS NOT ALWAYS CARING



Evacuation line health risk **is real.**

Evacuation line backflow potentially impacts one in five patients*. **Now more than ever**, it's critical to protect your patients from any exposure to saliva, blood and other potentially infectious material from previous procedures.

Safe-Flo™ Saliva Ejectors and Valves are unique one-way valves that provide a physical barrier, preventing harmful backflow.

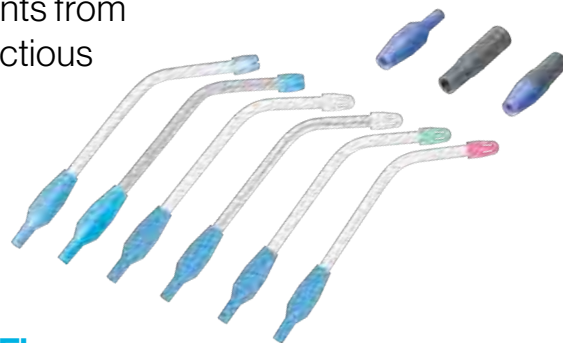

Visit us online at [HuFriedyGroup.com/Safe-Flo](https://www.hufriedy.com/Safe-Flo)

*Reference on file.

X-Ray Barriers

F702

Digital Sensor Sleeves

F702

BiteWing-Ease™ Barrier Sleeves

F702

Comfort Cushions

F703

Edge-Ease™ Cushions

F703

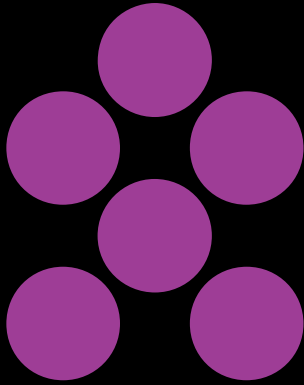

X-Ray Products

X-Ray Barriers and cushions keep equipment protected and patients comfortable during their x-rays.



X-Ray Barriers

Our variety of X-Ray Barriers cover digital sensors and cushions, and come in multiple size options.

Digital Sensor Sleeves

Digital Sensor Sleeves are manufactured from soft polyethylene with smooth seams to eliminate patient discomfort caused by similar sleeves with rough edges.



Digital Sensor Sleeves	
Clear	
500 per box	
Size 2, Large 1.625" x 8.5" (4.1 cm x 21.6 cm)	BCXSL
Size 1, Small 1.375" x 8.25" (3.5 cm x 21 cm)	BCXSS

X-Ray Products

BiteWing-Ease™ Barrier Sleeves

BiteWing-Ease™ Barrier Sleeves are all-in-one seamless barrier sleeves with comfort cushions and bite tabs that adjusts snugly to fit all types of sensors.

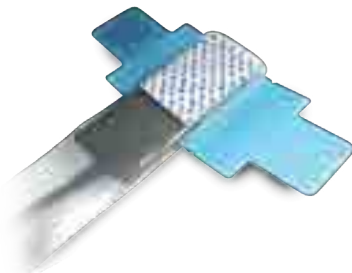

BiteWing-Ease™ Barrier Sleeves	
50 per box	
Large, White Adjustable to fit all size 2 sensors	BWEL



Comfort Cushions

Our variety of Comfort Cushions provide you with options to cover digital sensors, x-ray film, plates or positioning devices.

Edge-Ease™ Cushions

Edge-Ease™ Cushions provide a soft, comfortable edge to protect patient's soft tissue from digital sensor and x-ray film abrasions. These cushions allow the patient to bite down harder on devices for better positioning, resulting in more accurate images.



Edge-Ease™ Cushions

300 per box

Large, Blue

BWEEB

Fits long edge of size 2 film and sensors

Small, White

BWEEW

Fits short edge of size 1-2 film
and all 0-1 sensors

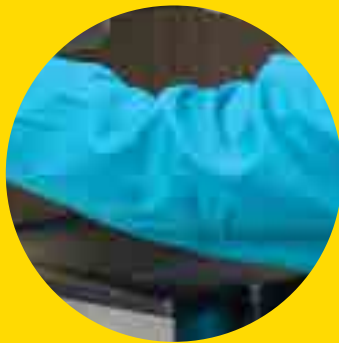
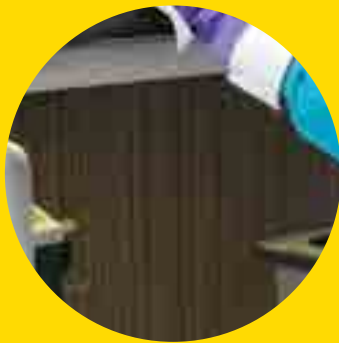

1) Centers for Disease Control and Prevention. Summary of Infection Prevention Practices in Dental Settings: Basic Expectations for Safe Care. Atlanta, GA: US Department of Health and Human Services, Centers for Disease Control and Prevention, National Center for Chronic Disease Prevention and Health Promotion, Division of Oral Health; March 2016.

Note: some of the devices, products, and/or programs advertised may not be licensed for sale outside the United States. Contact your local sales or customer care representative for availability details. For full product warranty details, please visit [HuFriedyGroup.com/services/warranties](https://www.hufriedy.com/services/warranties)

The contents of this catalog including, but not limited to, all text, photographs and graphics, are the sole and exclusive property of Hu-Friedy Mfg. Co., LLC its affiliates or related companies and may not be copied, reproduced or distributed without prior written permission.

Hu-Friedy Mfg. Co., LLC, 1666 E. Touhy Ave., Des Plaines, IL 60018 | [HuFriedyGroup.com](https://www.hufriedy.com)

All company and product names are trademarks of Hu-Friedy Mfg. Co., LLC its affiliates or related companies, unless otherwise noted. Sani-Cloth® is a registered trademark of Professional Disposables International, Inc.



Surface Disinfectants

According to the CDC, environmental surfaces can become contaminated during patient care and can serve as reservoirs of microbial contamination. Cleaning and disinfecting of environmental surfaces is one of the ways to protect against health-care-associated infections.¹

Intermediate-Level Disinfectants

G100

Low-Level Disinfectants

G103



Intermediate-Level Disinfectants

It is recommended by the CDC to clean and disinfect clinical contact surfaces that are not barrier-protected with an EPA-registered disinfectant after each patient use. Intermediate-level disinfectants should be used when surfaces are visibly contaminated with blood or other potentially infectious materials.¹



Learn more about [AdvantaClear™ Surface Disinfectant.](#)

AdvantaClear™ Surface Disinfectant

EPA registered: bactericidal, tuberculocidal, fungicidal and virucidal.

EPA REG NO.: 70144-4 and 70144-5.

AdvantaClear™ Surface Disinfectant is designed to clean and disinfect dental surfaces while effectively killing a broad spectrum of disease-causing microorganisms in two minutes or less.²

Designed to be compatible with a wide range of surfaces including acrylic, aluminum, brass, copper, stainless steel, chrome, plastics and more. Low alcohol/quaternary ammonium formulation, will not affix blood and soil to surfaces. Available in wipe and liquid formats.

Surface Disinfectants



AdvantaClear™ Surface Disinfectant Wipes
Canister
6" x 6.75" (15.2 cm x 17.1 cm)
160 wipes
IMS-2160



AdvantaClear™ Surface Disinfectant
Spray Bottle
24 fl. Oz. (710 mL)
IMS-2024



AdvantaClear™ Surface Disinfectant Bottle
1 gallon (3.8 L)
IMS-2128

1) Centers for Disease Control and Prevention. Summary of Infection Prevention Practices in Dental Settings: Basic Expectations for Safe Care. Atlanta, GA: US Department of Health and Human Services, Centers for Disease Control and Prevention, National Center for Chronic Disease Prevention and Health Promotion, Division of Oral Health; March 2016.

2) This product requires 2 minutes to kill *Mycobacterium bovis* BCG (TB) on pre-cleaned, hard, non-porous surfaces at room temperature. See product label for details.



Sani-Cloth® AF3 Disposable Wipes

EPA registered: tuberculocidal, bactericidal, virucidal.

EPA REG NO.: 9480-9.

Sani-Cloth® AF3 Germicidal Disposable Wipes are an alcohol and fragrance free formula that is effective against 45 microorganisms in 3 minutes, including 13 multi-drug resistant organisms (MDRO's), bloodborne pathogens, TB and viruses. Unique alcohol and fragrance-free formula designed to make surface disinfection more efficient for staff (ideal for use on sensitive dental equipment) and pleasant for patients. Formula is compatible with a broad range of hard non porous surfaces and equipment in health-care. Product packaging prominently displays contact time and categorization of pathogens for easy identification.



Sani-Cloth® AF3 Germicidal Disposable Wipes

Large wipes, canister

6" x 6.75" (15.2 cm x 17.1 cm)

160 wipes

SANAF3 (P13872)



Sani-Cloth® AF3 Germicidal Disposable Wipes

X-Large wipes, canister

7.5" x 15" (19.1 cm x 38.1 cm)

75 wipes

SANAFXL75 (P72584)



Super Sani-Cloth® Disposable Wipes

EPA registered: tuberculocidal, bactericidal, virucidal.

EPA REG NO.: 9480-4.

Super Sani-Cloth® Germicidal Disposable Wipes are a quaternary ammonium and isopropyl alcohol (IPA) formula that is effective against 34 microorganisms in 2 minutes, including 6 Multi-Drug Resistant Organisms (MRDO's), bloodborne pathogens, TB and viruses. Fast acting formulation is ideal for use in fast-paced environments requiring short contact time and broad coverage of microorganisms allowing for quick room/operator turnover on a broad range of surfaces and equipment. Product packaging prominently displays contact time and categorization of pathogens for easy identification.



Super Sani-Cloth® Germicidal Disposable Wipes

Large wipes, canister

6" x 6.75" (15.2 cm x 17.1 cm)

160 wipes

SANLS (Q55172)



Super Sani-Cloth® Germicidal Disposable Wipes

X-Large wipes, canister

7.5" x 15" (19.1 cm x 38.1 cm)

75 wipes

SANXLS75 (P86984)



Low-Level Disinfectants

It is recommended by the CDC to clean and disinfect clinical contact surfaces that are not barrier-protected with an EPA-registered hospital disinfectant after each patient. Low-level disinfectants can be used when surfaces are not visibly contaminated with blood.¹

Sani-Cloth® Plus Disposable Cloths

EPA registered: bactericidal, virucidal. EPA REG NO.: 9480-6.

Sani-Cloth® Plus Germicidal Disposable Cloths are a low alcohol/quaternary ammonium formulation that is effective against 18 microorganisms including bloodborne pathogens, viruses and bacteria in 3 minutes. Ideal for use in dental and health-care settings on a broad range of hard, non-porous surfaces and equipment.



Sani-Cloth® Plus Germicidal Disposable Cloths
 Large cloths, canister
 6" x 6.75" (15.2 cm x 17.1 cm)
 160 wipes
SANL (Q89072)



Sani-Cloth® Plus Germicidal Disposable Cloths
 X-Large cloths, canister
 7.5" x 15" (19.1 cm x 38.1 cm)
 65 wipes
SANXL2 (Q85084)

¹) Centers for Disease Control and Prevention. Summary of Infection Prevention Practices in Dental Settings: Basic Expectations for Safe Care. Atlanta, GA: US Department of Health and Human Services, Centers for Disease Control and Prevention, National Center for Chronic Disease Prevention and Health Promotion, Division of Oral Health; March 2016.

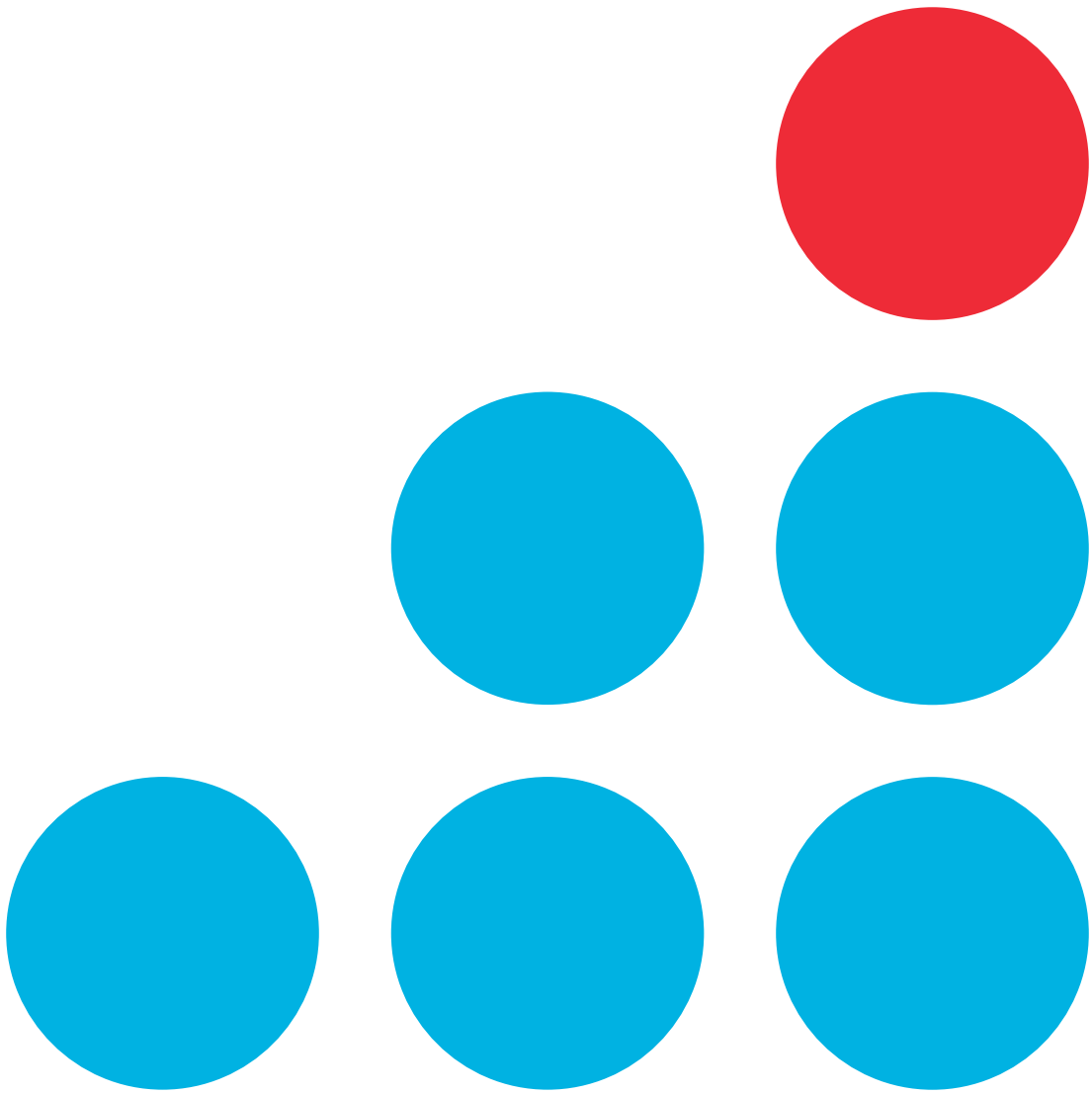



Index

#	H2	I	H9	S	H19
A	H3	K	H13	T	H25
B	H3	L	H13	U	H26
C	H4	M	H13	V	H27
D	H5	N	H14	W	H27
E	H5	O	H14	X	H27
F	H8	P	H15	Y	H27
G	H8	Q	H18	Z	H27
H	H9	R	H18		

#

- 1-015 A822
- 8-905DD A713 A717 A842
- 10-30-05 C142
- 10-100-04 A821
- 10-130-03 A708 A710 A716 A718 A821
- 10-130-05 A606 A607 A707 A709 A711 A712 A716 A717 A718 A821 A904 C141
- 10-130-05A A821
- 10-130-05D A821
- 10-130-05E A707 A709 A711 A716 A718 A822 A902 A903 A904
- 10-130-5EM A719 A822
- 10-130-07 A821
- 10-130-07K A821
- 10-130-08 A822 A919
- 10-130-70 A606 A713 A823 A903 A919
- 10-255-11 A820
- 10-255-12 A820
- 10-255-15 A820
- 10-255-25 A820
- 10-256-12 A820
- 10-256-15 A820
- 40-060 C315
- 40-062 C315
- 40-064 C315
- 40-066 C315
- 40-811 A820
- 40-812 A820
- 40-812B A820
- 40-815 A820
- 40-815C A820
- 40-825 A820
- 678-001 A1019
- 678-002 A1019
- 678-011 A1019
- 678-013 A1019
- 678-014 A1019
- 678-014A A1019
- 678-018 A1019
- 678-020 A1019
- 678-021 A1019
- 678-036 A1019
- 678-101 A1006
- 678-101L A1002 A1003 A1006 C140
- 678-102 A1006
- 678-103 A1003 A1006 C140
- 678-104 A604 A850 A1007
- 678-105 A1007
- 678-106 A1007
- 678-107 A1002 A1003 A1007 C140
- 678-107L A1007
- 678-109 A1007
- 678-110 A1007
- 678-111 A1006 A1019
- 678-113 A1006 A1019
- 678-114 A1019
- 678-114R50 A1019
- 678-200 A1009
- 678-201 A1009
- 678-201L A1003 A1009 C140
- 678-202 A1009
- 678-203 A603 A604 A1002 A1010
- 678-204 A1010
- 678-205 A1003 A1010
- 678-206 A1010 A1019
- 678-207 A1010 A1019
- 678-208 A1010 A1019
- 678-210 A1010
- 678-211 A1010
- 678-212 A1003 A1016 C140
- 678-212M A1016
- 678-216 A1011
- 678-219 A1011
- 678-220L A1003 A1011
- 678-221 A603 A604 A1011
- 678-221M A1011
- 678-221MC A603
- 678-222 A1002 A1010
- 678-225 A603 A604 A1011
- 678-225M A1011
- 678-301 A1013
- 678-302 A604 A1003 A1012 C140
- 678-302 A1012
- 678-303 A1013 A1019
- 678-304 A603 A1002 A1003 A1012 C140
- 678-305 A1012
- 678-306 A1013
- 678-307 A1002 A1013
- 678-307S A1013
- 678-308 A1013
- 678-309 A1013
- 678-310 A1013
- 678-311 A1013
- 678-312 A603 A1012
- 678-315 A1013
- 678-316 A603 A1013
- 678-317 A1013
- 678-318 A1012
- 678-319 A1013
- 678-320 A1013
- 678-321 A1013
- 678-322 A1013
- 678-323 A1013
- 678-324 A1002 A1013
- 678-325 A1003 A1012
- 678-326 A1012
- 678-327 A1002 A1014
- 678-328-20 A1014
- 678-328-21 A1014
- 678-330 A1002 A1003 A1015 C140
- 678-331 A1015
- 678-332 A1015
- 678-340 A1014
- 678-341 A1014
- 678-342 A1014
- 678-500 A1003 A1007
- 678-501 A1003 A1009
- 678-502 A1014
- 678-503 A1003 A1010 A1019
- 678-504 A1003 A1016
- 678-505 A1016
- 678-506 A1017
- 678-700 A1006
- 678-701 A1007
- 678-702 A1009
- 678-702-90 A1009
- 678-703 A1011
- 678-704 A1014
- 678-704SER A1014
- 678-705 A1015
- 678-706 A1017
- 678-707 A1017
- 678-708 A1016
- 678-709 A1011
- 678-800 A1002 A1004
- 678-801 A1002 A1004
- 678-802 A1002 A1004
- 678-803 A1002 A1004
- 678-804 A1005
- 678-805 A1005
- 678-807 A1005
- 678-808 A1005
- 678-809 A1005
- 678-810 A1005
- 678-811 A1005
- 678-812 A1005
- 678-813 A1005
- 678-904 A1017
- 678-905 A1003 A1017 C140
- 678-906 A1003 A1017
- 678-907 A1003 A1017
- 678-908 A1017
- 678-909 A1017
- 678-910 A1017
- 678-911 A1017
- 678-912 A1017 C140
- 678-913 A1017
- 678-914 A1003 A1017
- 678-916 A1017
- 1808S A203 A305
- 19100 A917
- 19101 A917
- 19200 A917
- 19201 A917
- 19202 A917
- 19300 A917
- 19301 A917
- 19302 A917
- 19400 A917
- 19401 A917
- 19402 A917
- 19500 A917
- 19600 A917
- 19700 A917
- 19701 A917
- 19702 A917
- 19800 A917
- 19801 A917
- 19802 A917
- 32007 E304
- 32009 E304
- 33008 E304
- 33009 E304
- 33010 E304
- 33015-3 E204
- 33015-9 E204
- 33015-14 E204
- 33015-15 E204
- 33015-16 E204
- 33016-1 E205
- 33016-2 E205
- 33016-3 E205
- 33016-9 E205
- 33016-10 E205
- 33016-11 E205
- 33016-12 E205
- 33016-13 E205
- 33016-14 E205
- 33016-15 E205
- 33016-16 E205
- 33017-1 E205
- 33017-9 E205

33017-10 E205
33017-11 E205
33017-12 E205
33017-17 E205
33018 E205
33019 E205
33020 E205
33034-9 E202
33034-9-CAP E207
33034-10 E202
33034-10-CAP E207
33034-14 E202
33034-14-CAP E207
33034-16 E202
33034-16-CAP E207
33035-9 E202
33035-9-CAP E207
33035-10 E202
33035-10-CAP E207
33035-12 E202
33035-12-CAP E207
33035-14 E202
33035-14-CAP E207
33035-16 E202
33035-16-CAP E207
33037-9 E202
33037-9-CAP E207
33037-10 E202
33037-10-CAP E207
33037-11 E202
33037-11-CAP E207
33037-12 E202
33037-12-CAP E207
33037-17 E202
33037-17-CAP E207
35000 E305
35100 E305
35325 E305
35350 E305
35360 E302
35400 E305
35500 E305
43003 E302
43004 E302
43005 E302
43006 E302
43009 E302
43055 E206
49250 E105
49450 E105
51000 E103
51975 E102
52005 E303
52006 E303
53034-9 E203

53034-12 E203
53034-16 E203
53035-9 E203
53035-12 E203
53035-16 E203
53037-9 E203
53037-12 E203
53037-16 E203
53055 E206
56100 E102
56200 E102
56200-ADJS E102
56300 E102
56400 E102
56500 E102
56600 E103
56800 E103
56800-CHAIR E103
56950 E103
371030 A825
371040 A825
371050 A825
371060 A825
371112 A824
371115 A824
371212 A824
371215 A824
371315 A824
371325 A824
371610 A825
371611 A825
371612 A825
371613 A825
371615 A825
371712 A824
371716 A824
376400 A825
376700 A825
1013005D1 A821
ED46 A816
IMEDIN131 A906
KIT-ROTH A604

A

AF1/4 A640
AF31/32 A640
AJSRKIT A717
AKRO-CASS A610
AKRO-FLEX A610
AKRO-INFIN A610
ALLENBASIC A717
ALLENBASIX A717
ALLENCARD A717 A771

ALLENKIT A717
APAIRHOSE B103
AP-CM B105
AP-CN B105
APF2 A641 A906 C131 C134
 C135 C136 C137 C138
APF2E A905
APFILTER B103
APH2OHOSE B103
APHP90 B103
APHP120 B102 B103
APHPPERIO B102 B103
APICDKIT B103
APK9 B103
APNDLKIT B103
APORINGS B103
APPAIR B102 B203
APPCCAP B103
APPCPERIO B103
APPERIOTIPS B103
AP-PM B104
AP-PN B104
ART2 A626
ASPA A720
ASPB1 A720
ASPB2 A720
ASPB3 A720
ASPCG3 A720
ASPCH A721
ASPCT1 A721
ASPCT1W A721
ASPCT2 A721
ASPCT2W A721
ASPCT3 A721
ASPCT3W A721
ASPCT4 A721
ASPCT4W A721
ASPFR6 A721
ASPFR8 A721
ASPFR10 A721
ASPFR12 A721
ASPON A721
ASPOS1 A721
ASPOS2 A721
ASPOS3 A721
ASPOS4 A721
ASPY A721
AZIMENDOKIT A903

B

BAGS F408
BB2/29 A649
BB2DE A649

BB2SE A649
BB18 A649
BB21 A650
BB21B A650
BB21B6 A650 C138
BB21B8 A650
BB26/27S A649
BB26/27S6 A649
BB27/29 A649
BB27/296 A649 C131 C138
BB27/297 A649
BB27/298 A649
BB186 A649
BB216 A650
BBKOT1 A620
BBKOT2 A602 A620
BBKOT3 A620
BBKOT4 A620
BBKOT5 A620
BBKOT6 A620
BBKOT11 A620
BBKOT12 A620
BBKOT13 A620
BBKOT14 A621
BBKOT26/27 A621
BBL2 A650
BBL3 A604 A650
BBL36 A650
BBROM A650
BCCS F403 F404
BCLST F403
BCSAWS F307
BCSAWSB F307
BCSAWSCL F307
BCSAWSWH F307
BCSSBO F404
BCSSO F404
BCTS710 F404
BCTS1014 F404
BCTS1114 F404
BCTS1116 F404
BCXR F404
BCXSL F702
BCXSS F702
BER6 A744 A745
BER6X A744 A745
BER7 A744 A745
BER7X A744 A745
BER11 A744 A745
BER11X A744 A745
BF1W A746
BF1W6 A746
BF1X A747
BF1X6 C141
BF1X6 A747 C142

BF2W A746
BF2W6 A746
BF2X A718 A747
BF2X6 A711 A747
BF3X A747
BF3X6 A747
BF12 A746
BF21 A746
BF45 A747
BF52 A747
BF64 A747
BF67 A747
BF126 A746
BF216 A746
BF456 A747
BF526 A747
BF646 A747
BF676 A747
BFBL F402
BFCL F402
BG A668
BIOKIT A607
BLPGREF A669
BMGRINDSS A776
BMGRINDTI A776
BMSCREWSET A776
BMSS A776
BMTI A776
BONEKIT A714
BP300 A1018
BP300S A1018
BPACK A712 A716 A773
 C139
BPEMEKIT A903
BPMEKIT A903
BPS1 A1018
BPS2 A1018
BSJ05 A771
BWEEB F703
BWEEW F703
BWEL F702

C

C10BI25 C210
C10SK C210
C36/376 A713 A723
C36/379 A713 A723
CBBC A771
CBFL112 A727
CBFL214 A727
CBMS10 C210
CC1 A726
CC2 A726

CC4 A726
CC7 A726
CC8 A727
CC9 A727
CC13 A727
CC15 A727
CCIA A613
CCIB A613
CCIC A613
CCID A613
CCIE A613
CCIF A614
CCIG A614
CCIH A614
CCII A614
CD1/2 A646
CD3/6 A646
CD3/66 A646 C131 C138
CD3/67 A646
CD3/68 A646
CD4/56 A646
CD4/57 A646
CD89/926 A646 A902 C138
CD89/927 A646
CD89/928 A646
CD90B A646
CDWACD A646
CG1 A726
CG2 A726
CG5 A726
CG6 A726
CG9 A726
CHUSET A606
CI6001 A615
CI6056 A615
CIBIOA A607 A618
CIBIOB A607 A618
CIBIOD A607 A618
CIBIOE A607 A618
CIBIOY A607 A618
CIBIOZ A607 A618
CIGFT1 A610
CIGFT2 A610
CIGFT3 A610
CIGFT4 A611
CIGFT5 A611
CIGFT6 A611
CIGFT16 A610
CIGFT18 A610
CIGFT26 A610
CIGFT36 A610
CIGFT38 A610
CIGFT46 A611
CIGFTMIN16 A611
CIGFTMIN36 A611

CIGFTMIN38 A611
CIGFTMIN46 A611
CIGFTMIN48 A611
CIGFTMINI1 A611
CIGFTMINI3 A611
CIGFTMINI4 A611
CKN1/26 A723
CKN3 A727
CKN55 A727
CKN75 A727
CL84 A728
CL84X A728
CL85 A729
CL85X A729
CL86 A729
CL86X A709 A711 A713
 A716 A718 A729
CL87 A729 A904
CL87X A729
CL88 A729
CL88X A729
CL846 A718 A728 A904
CL856 A712 A729 A902
 A903 A904
CL866 C141
CL866 A709 A711 A713
 A729 A903 A904
 C142
CL876 A716 A729
CL886 A718 A729
CLC40C A722
CLC40CWM A722
CLC40L A722
CLEARKIT A1002
CLG A606 A669
CLGS A606 A669
CLP1 A668
CLP2 A668
CLR6 A668 A941
CM2 A730
CM2/4 A731 A904 C139
CM2/4S6 A707 A708 A710
 A718 A731
CM2/4X A707 A708 A710
 A712 A731
CM2/46 C142
CM4 A730
CM4L A730
CM4R A730
CM5L A730
CM6R A730
CM8 A729
CM9 A729
CM10 A729 A904
CM11 A729 A904

CM12 A729 A904
CM12S6 A729
CM18 A727
CM26 A730
CM46 A730
CM86 A729
CM96 A729
CM106 A716 A729
CM116 A729
CM126 A729
CO1 A724
CO2 A724
CO26 A724
CO36 A724
CO46 A724
COMPKIT A602
CP1/2 A626
CP3/4 A606 A626
CP5/6 A626
CP7/10 A626
CP8/9 A626
CP8/9H A624
CP8/9H6 A624
CP8/9H8 A624
CP8/9H9 A624
CP11/12 A626
CP13/14 A624
CP14/14 A625
CP14/14-0 A625
CP14/14-09 A607 A625
CP14/149 A625
CP15/15 A625
CP15/15-0 A625
CP15/15-09 A607 A625
CP15/16 A624
CP15/159 A625
CP15/166 A624
CP15/169 A624
CP17/18 A624
CP17/186 A624
CP17/189 A624
CP19 A625
CP20 A627
CP21 A627
CP21/21C A627
CP22 A627
CP22/22C A627
CP23 A627
CP24 A627
CP24/24C A627
CP30/31 A630
CP32/33 A630
CP34/35 A630
CP40/41 A626
CP44S6 A625

CP44S9 A607 A625
CP45S6 A625
CP45S9 A607 A625
CP51/52 A625
CP53/54 A625
CP53/546 A625
CP54887 A624
CPF4 A724
CPF16 A724
CPF26 A724
CPF36 A724
CPF46 A724
CR20 A647
CR21 A647
CR206 A607 A647
CR216 A647
CRB A718 A807
CRC A807 A903
CRCH1 A660
CRCH2 A660
CRGR A660
CRH A663
CRK02 C210
CRL A659
CRLABANCA A808
CRM C141
CRM A716 A718 A807 C142
CRM2 A807 A902 A903
CRMS A716 A807
CRMT A807 A904
CRMX A716 A719 A807
CRNT12 A648
CRO2 A808
CRO3 A808
CRPA A808
CRPC A808
CRRP A659
CRS A663
CRSA A808
CRSPR A607 A662
CRTC A663
CRU A659
CRURBAN A712 A719 A807
CRW1 A716 A808
CRW2 A808
CS24 A664
CS246 A664 C131 C134
 C136 C137
CS324 A664
CSA6 A664 A906
CSBI25 C210
CSEUWES6 A709 A710 A773
CSLABANCA6 A772
CSNT5 A904
CSNT5 A664

CSNT6 A665
CSNT7 A665
CSNT8 A665
CSNT9 A665
CSOLT3/46 A724
CST060 C208
CST120 C208
CST480 C208
CTG A723
CTG6 A723
CTG-O A723
CTG-O6 A723
CUPE A771
CURBAN1 A718 A723
CURBAN2 A723
CV3T A644
CV4T A644
CV5T A644
CV5T6 A644
CV6T A644
CV104 A645
CVA1 A644
CVA2 A644
CVA3 A644
CVCL4 A644
CVDH152 D305
CVDH154 D305
CVDH158 D305
CVDH158-82 D305
CVDH8200 D305
CVFR2/3 A645
CVFR2/36 A645
CVH1/MC2 A645
CVH1/MC3 A645
CVHL1 A645
CVHL1/2 A643
CVHL1/26 A643 A906 C131
 C138 C140
CVHL1/27 A643
CVHL1/28 A643
CVHL1/29 A643
CVHL2 A645
CVHL3 A643
CVHL3S A643
CVHL3S6 A643 A905
CVHL3S7 A643
CVHL66 A604
CVIPC A643 A646
CVIPC6 A643 A646
CVIPC7 A643 A646
CVIPC8 A643 A646
CVIPCKOT4 A602 A605
 A620
CVIPCOA A643
CVKOT1 A619

CVKOT1X A605 A615
CVKOT2 A620
CVKOT3 A622
CVL7 A645
CVLC5 A671
CVLC56 A671
CVR2551 D302
CVR3250 D302
CVR3251 D302
CVR3252 D302
CVR3253 D302
CVR3254 D302
CVR3255 D302
CVR9725 D104
CVROA A671
CVS3010 D302
CVS3015 D302
CVS3020 D302
CVS3030 D302
CVS3050 D302
CVS7545 D303
CVS7547 D303
CVS7560 D303
CVS9111 D302
CVS9113 D302
CVS9300 D302
CVSA A645
CVSPR18 A645
CVSPR186 A645
CVT120 C208
CVT520 C208
CVTCA/B A646
CVTCC/D A646
CVTCE A646
CVTH1 A645
CVTH2 A645
CVV1000-DP D104
CVV3000 D302
CVV7501 D303
CVV7502 D303
CVVC250-A D304
CVVH A671
CVWI8 A643
CVWI86 A607 A643 C131
 C136 C137
CVWI87 A643
CVWKOT8 A622
CVWL1 A644
CVWL3 A644
CVWR1 A644
CVWR2 A644
CW1 A727
CW2 A727
CX1 F202
CXBG F203

CXBL F203
CXCL F203
CXDR F203
CXGR F203
CXLV F203
CXPE F203
CXSI F203
CXWH F203
CXYE F203

D

DIS-100 C212
DNC F105
DP1 A125 A607 A712 A906
DP2 A125 A202 A604
 A606 A906 C131
 C134 C136 C137
 C138 C141 C142
DP3 A125
DP4 A125
DP17 A124 A718
DP18 A124 C140
DP18L A124 A904
DP19 A125
DP40B10 D103
DP317 A125
DP318 A125
DP365B10 D103
DP365M10 D103
DP365VC D104
DP365VC-CA D104
DPTTEST D107
DPU17 A124 A603 A716 A717
 A718 A905 C130
DS503L D105
DSCFINE A304
DSCMED A304
DSCSET A202 A304
DSCXFINE A304

E

E1 A734 A745
E1C A734 A745
E1L A735 A745
E1LX A738 A745
E1R A735 A745
E1RX A738 A745
E2 A734 A745
E2C A734 A745
E2S A745
E2S A735
E3C A734 A745

E3S A735 A745
E4 A735 A745
E4L A735 A745
E4R A735 A745
E5 A735 A745
E6 A736 A745
E6X A738 A745
E7 A736 A745
E7X A738 A745
E8 A736 A745
E9 A815
E9L A815
E9L6 A815
E9R A815
E9R6 A815
E11 A736 A745
E11A A736 A745
E11H A745
E11LX A738 A745
E11M A736 A745
E11RX A738 A745
E12LX A738 A745
E12M A736 A745
E12RX A738 A745
E13M A736 A745
E14LX A738 A745
E14RX A738 A745
E15 A736 A745
E16 A736 A745
E19 A736 A745
E20 A736 A745
E21 A711 A718 A734 A745
E22 A711 A718 A734 A745
E23 A745
E25 A734 A745
E26 A734 A745
E31 A734 A745
E31F A736 A745
E32 A734 A745
E32F A736 A745
E34 A735 A745
E34S C141
E34S A711 A735 A745 C142
E34SSERR A735
E34SSM A735 A745
E38 A736 A745
E39 A736 A745
E40 A734 A745
E41 A734 A745
E44 A734 A745
E44C A736 A745
E45 A734 A745
E46 A736 A745
E46R A736 A745
E51 A736 A745
E52 A736 A745
E63 A736 A745
E69W A737 A745
E71 A735 A745
E72 A735 A745
E73 A735 A745
E74 A735 A745
E77 A737 A745
E77R A737 A745
E77RSM A737 A745
E80 A737
E80 A745
E81 A737 A745
E81A A737 A745
E81E A737 A745
E92 A737 A745
E93 A737 A745
E94 A815
E95 A815
E96 A815
E98 A737 A745
E190 A737 A745
E191 A737 A745
E301 A711 A718 A735 A745
 C141 C142
E301SERR A735
E301SM A735 A745
E301W A735 A745
E302 A735 A745
E303 A735 A745
E304W A735 A745
EA A737 A745
EA1C A734 A745
EA2C A734 A745
EA3C A734 A745
EA30 A734 A745
EA31 A734 A745
EB A737 A745
EBSM A718 A737 A745
ED1 A816
ED2 A816
ED3 A816
ED4 A816
ED10 A816
ED11 A816
ED16 A816
ED26 A816
ED36 A816
ED106 A816
ED116 A816
EDLL3 A739 A745
EDLL5 A739 A745
EDLR3 A739 A745
EDLR5 A739 A745
EH5 A737 A745
EH6 A737 A745
EHB1 A817
EHB2 A718 A817
EHB2H A817
EHB3 A718 A817
EHB3H A817
EHB4 A817
EHB5 A817
EHB13/14 A817
EHB13/14H A817
EHB13/14H6 A817
EHB13/14X A711 A713 A817
EHB13/146 C141
EHB13/146 A711 A713 A817
 C142
EHO1 A818
EHO2 A818
EHO2/3 A818
EHO2/36 A818
EHO3 A818
EHO4 A818
EL2C A741 A745
EL2CLX A745
EL2CSM A741 A745
EL2CX A741 A745
EL2S A741 A745
EL2SLX A745
EL2SSM A741 A745
EL2SX A741 A745
EL3C A707 A711 A741 A745
EL3CLX A745
EL3CSM A741 A745
EL3CX A741 A745
EL3S A707 A711 A745
EL3SLX A745
EL3SSM A745
EL3SX A718 A745
EL4C A741 A745
EL4CLX A745
EL4CSM A741 A745
EL4CX A741 A745
EL4S A741 A745
EL4SLX A745
EL4SSM A741 A745
EL4SX A741 A745
EL5C A707 A711 A741 A745
EL5CLX A745
EL5CSM A741 A745
EL5CX A741 A745
EL5S A707 A711 A741 A745
EL5SLX A745
EL5SSM A741 A745
EL5SX A741 A745
ELKIT A707
ELSLIM2CL A740
ELSLIM2CLX A740
ELSLIM2CS A740
ELSLIM2CSX A740
ELSLIM2SL A740
ELSLIM2SLX A740
ELSLIM2SS A740
ELSLIM2SSX A740
ELSLIM3CL A740
ELSLIM3CLX A740
ELSLIM3CS A740
ELSLIM3CSX A740
ELSLIM3SL A740
ELSLIM3SLX A740
ELSLIM3SS A740
ELSLIM3SSX A740
EMLL3 A739 A745
EMLL5 A739 A745
EMLR3 A739 A745
EMLR5 A739 A745
ENC2 F102
ENC3NW F104
ENC3NWU F104
ENC4NW F104
ENC4NWU F104
ENC38 F102
ENC48 F102
ENC100 F103
ENC212 F102
ENC312 F102
ENC412 F102
ENC416 F102
ENC4100 F103
ENCC F103
ENCC3 F103
ENCC4 F103
ENCNW F104
ENCNW4K F104
ENCNWU F104
ENCNWUB F104
ENDOKIT A902
ENDO-SXKIT A904
EPD6578XTS A622
EPL1 A902 A906 A941 C135
EPTKIT A706
EPTKITX A706 A707
EPTLGD A706 A742 A745
EPTLGDX A706 A742 A745
EPTLGM A706 A742 A745
EPTLGMX A706 A742 A745
EPTSMC A706 A707 A713
 A742 A745
EPTSMCX A706 A707 A713
 A742 A745
EPTSMMD A706 A742 A745
EPTSMDX A706 A742 A745

- EPTSMM** A706 A742 A745
- EPTSMMX** A706 A742 A745
- EPTSMS** A706 A707 A713
A742 A745
- EPTSMSX** A706 A707 A713
A742 A745
- EPTSSP** A706 A707 A711
A713 A718 A742
A745
- EPTSSPX** A706 A707 A711
A713 A742 A745
- ERAF1** A745 A818
- ERAF3KA** A745 A818
- ESCC** F103
- EW1** A819
- EW2** A819
- EW3** A819
- EW4** A819
- EW5** A819
- EW6** A819
- EW26** A819
- EW36** A819
- EW46** A819
- EW56** A819
- EW66** A819
- EWJL** A737 A745
- EWJR** A737 A745
- EWJS** A737 A745
- EWS16** A819
- EX3A/TU17** A114
- EX3A/TU176** A114
- EX23/6** A114
- EX23/66** A114 A603 A607
- EXAF1** A921
- EXAF2** A922
- EXC6** A631
- EXC14** A631
- EXC17** A632
- EXC17H** A632
- EXC17H6** A632
- EXC17H7** A632
- EXC17W** A632
- EXC17WH** A632
- EXC17WH6** A632
- EXC18** A632
- EXC18H** A632
- EXC18H6** A632
- EXC18W** A632
- EXC18WH** A632
- EXC18WH6** A632
- EXC19** A604 A632
- EXC19H** A632
- EXC19H6** A632
- EXC19H7** A632
- EXC19W** A632
- EXC19WH** A632
- EXC19WH6** A632
- EXC31L** A904 A906 A930
- EXC31L6** A906 A930 C135
- EXC31LX** A902 A930
- EXC31W** A930
- EXC31W6** A930
- EXC31WX** A930
- EXC32L** A930
- EXC32L6** A905 A930
- EXC32LX** A930
- EXC33L** A904 A930
- EXC33L6** A930
- EXC33LX** A930
- EXC36/37** A633
- EXC36/376** A633
- EXC38/39** A633
- EXC38/396** A633
- EXC38/397** A633
- EXC40/41** A633
- EXC44/45** A633
- EXC44/456** A607 A633
- EXC61/62** A633
- EXC63/64** A633
- EXC63/646** A633
- EXC65/66** A633
- EXC125/6** A634
- EXC127/8** A634
- EXC129/0** A634
- EXC129/06** A634
- EXC131/2** A634
- EXC153/4** A634
- EXC153/46** A634
- EXC176** A632
- EXC177** A632
- EXC178** A632
- EXC179** A632
- EXC186** A602 A632 A906
C131 C134 C137
C138
- EXC187** A632
- EXC188** A632
- EXC189** A632
- EXC196** A603 A632
- EXC197** A632
- EXC198** A632
- EXC220/1** A633
- EXC220/16** A633
- EXC242** A634
- EXC243** A634
- EXC244** A634
- EXC245** A634
- EXC246** A634
- EXC2429** A634
- EXC2466** A634
- EXC2469** A634
- EXCE1** A631
- EXCE2** A631
- EXCE16** A631
- EXCE26** A631
- EXCGL2** A930
- EXCKOT1** A621
- EXCKOT2** A602 A621
- EXCKOT3** A621
- EXCKOT4** A621
- EXCKOT5** A621
- EXCKOT6** A621
- EXCKOT61/2** A622
- EXCKOT63/4** A622
- EXD1** A113 A904
- EXD2** A113
- EXD2A** A113 A202
- EXD2A6** A113
- EXD2H** A113
- EXD2H6** A113
- EXD2R/2L** A113
- EXD2R/2L6** A113
- EXD2R/2L7** A113
- EXD2XTS** A114
- EXD3** A113
- EXD3CH** A113
- EXD3CH6** A113
- EXD3CH7** A113
- EXD3CH8** A113
- EXD3CHXTS** A114
- EXD3ES** A113
- EXD3ES6** A113
- EXD3ES7** A113
- EXD3ES8** A113
- EXD5** A114 A906
- EXD5XTS** A114
- EXD6** A114
- EXD11/12** A114
- EXD11/12A6** A114 A202
C133 C143
- EXD11/12A7** A114
- EXD11/12A8** A114
- EXD11/12AF** A114
- EXD11/126** A114 A202
A244 C132
- EXD11/127** A114
- EXD11/128** A114
- EXD16** A113 A605
- EXD26** A113
- EXD27** A113
- EXD28** A113
- EXD36** A113
- EXD56** A114 A604 A717 C130
C134 C136 C137
C138 C143 C144
- EXD57** A114
- EXD58** A114
- EXD66** A114 A717
- EXDEN1** A113
- EXDEN16** A113
- EXDG16** A904 A906 A929
- EXDG16/17** A905 A929
- EXDG16/17X** A929
- EXDG16/23** A929
- EXDG16/23X** A929
- EXDG16/176** A902 A903
- EXDG16T** A929
- EXDG16X** A902 A929
- EXDG166** A906 A929 C135
- EXDG167** A906 A929
- EXKOT11** A619
- EXKOT23** A602
- EXS3** A111
- EXS3A** A111
- EXS3A6** A111
- EXS3A7** A111
- EXS3A8** A111
- EXS6** A111
- EXS6A** A111
- EXS6A6** A111
- EXS6A7** A111
- EXS6L** A111
- EXS6L6** A111
- EXS6L8** A111
- EXS6XL** A112 A905
- EXS8** A112
- EXS9** A112
- EXS17** A112
- EXS23** A112 A1003
- EXS36** A111
- EXS54** A112
- EXS66** A111
- EXS68** A111
- EXS86** A112
- EXS96** A112
- EXS97** A112
- EXS98** A112
- EXS176** A112
- EXS236** A112 A603
- EXS237** A112
- EXS238** A112
- EXS546** A112
- EXTU17** A112
- EXTU17/23** A114
- EXTU17/236** A114 A202
- EXTU17/237** A114
- EXTU17/238** A114

EXTU176 A112
EXTU178 A112
EXTU1723XT A114

F

F1 A760
F1IS A751
F1S A765
F1XS A754
F1XSD A749
F3FS A757
F10S A758
F13XS A754
F13XSD A750
F16 A757
F16M A757
F16S A765
F17 A757
F18L A758
F18R A758
F21XS A754
F21XSD A750
F23 A757
F23IS A752
F23K A763
F23S A765
F23XS A754
F32 A761
F32A A761
F35XS A755
F35XSD A749
F36XS A755
F36XSD A750
F39 A765
F40 A765
F53L A758
F53LIS A752
F53R A758
F53RIS A752
F62 A760
F65 A766
F67XS A755
F67XSD A751
F69 A766
F69IS A752
F88L A759
F88LIS A752
F88R A759
F88RIS A752
F89 A759
F90 A759
F99C A761
F101 A760

F150 A760 C142
F150A A760
F150AS A760
F150IS A751
F150K A763
F150S A764
F150SR A764
F150XAS A765
F151 A758 C142
F151A A756
F151AS A756
F151IS A751
F151K A763
F151S A764
F151SR A764
F151XAS A765
F203 A756
F210H A758
F210S A759
F217 A757
F222 A757
F222IS A751
F286 A761
F300 A766
F301 A766
FABL F407
FAF1 A711 A753
FAF1IS A753
FAF1XS A755
FAF1XSD A749
FAF35XS A707 A755
FAF35XSD A749
FAF36XS A707 A755
FAF36XSD A750
FAF150 A707 A711 A718 A753
FAF150IS A752
FAF151 A707 A711 A718 A753
FAF151IS A753
FAF222 A711 A753
FAF222IS A753
FAFX67A A711 A754
FAFX74N A711 A754
FAWH F407
FB11/12 A748
FB11/126 A748
FBAQ F407
FBBL F407
FBC F407
FBDR F407
FBGR F407
FBLV F407
FBPE F407
FBSI F407
FBWH F407
FBYE F407

FCBL F407
FCWHBX F407
FDBL F407
FDWH F407
FE/LD A1018
FEWH F407
FF F407
FH3/7 A242
FH3/76 A242
FH5/11 A242
FH5/116 A242
FH9/10 A242
FH9/106 A242
FMD1 A761
FMD2 A759
FMD3 A756
FMD4 A757
FMINI F407
FO10/11 A242
FO10/116 A242
FO12/13 A242
FO12/136 A242
FQUINCEY1X A783
FQUINCEY2X A783
FRCE A727
FS A308
FS1/2S A748
FS1/2S6 A718 A748
FS3/4S A748
FS3/4S6 A748
FS9/10S A748
FS9/10S6 A748
FST A308
FX1 A761
FX1CE A762
FX1E A761
FX2CE A762
FX3CE A762
FX4CE A762
FX5CE A762
FX6CE A762
FX7 A761
FX7CE A762
FX7E A761
FX13E A756
FX17 A759
FX17E A759
FX18 A759
FX18E A759
FX22 A757
FX22E A757
FX33 A766
FX35E A761
FX44XS A755
FX44XSD A750

FX45XS A755
FX45XSD A750
FX46L A766
FX46LE A766
FX49 A766
FX49E A766
FX51 A767
FX51E A767
FX51XS A756
FX51XSD A750
FX67A A759
FX73 A757
FX73XS A756
FX73XSD A751
FX74 A767
FX74N A767
FX76S A767
FX79 A757
FX79E A757
FX79XS A756
FX79XSD A751
FX97 A767
FX97E A767
FX233 A767
FX233E A767

G

GCAPTPK C312
GCFBKSF C304
GCFCX C304
GCFCXCS C305
GCFCXSF C305
GCFCXSFSS C306
GCFCXSSF C305
GCFCXU C304
GCFCXUSF C304
GCIBL C309
GCIBL100 C309
GCIBLSF C309
GCICXB C310
GCICXBSF C310
GCICXS C310
GCICXT C310
GCIGR C309
GCILV C309
GCILVSF C309
GCIPK C309
GCIPKSF C309
GCIPWB C310
GCIPWBSF C311
GCIPWS C310
GCIPWT C310
GCISA C309

GCITE C309
GCITQ C309
GCP113 A653
GCP113NS A653
GCP1136 A653 C131 C134 C137
GCPAT C313
GCPBAL A654
GCPBL C307
GCPBL100 C307
GCPBLSF C308
GCPBN1 A605 A653
GCPCSI1 A653
GCPCSI1NS A653
GCPCSI16 A653
GCPG7 A653
GCPG7NS A653
GCPG7NS6 A653
GCPG76 A653
GCPLV C307
GCPLVSF C308
GCPPK C307
GCPPKSF C308
GCPS6 A654
GCPS66 A654
GCPW C306
GCPWS C306
GCPWSSF C307
GCPYD1 A605 A654
GCPYD16 A654
GCPYE C307
GCRO A661
GCR45 A661
GCR90 A661
GCROS A661
GCS C308
GCSS C314
GCSS9 C314
GCSS9B C314
GCSSB C314
GDBRESP C302
GF36 A647
GF366 A726
GK2S A648
GK7 A648
GK14L A648
GK29 A648
GMLRESP C303
GPHF A770
GPHF6 A770
GPLUSBL C311
GPLUSKA C311
GPLUSPK C311
GPLUSWHSF C311
QLFT-B C303

QLFT-S C303
GRK1 A652
GRM1 A652
GRM2 A652
GRM3 A652
GRM4 A652

H

H1 A774 A905
H2 A712 A774 A903 A906
H3 A605 A716 A774
H3C F105
H4 A718 A774
H5 A774
H6C F105
HAC A774
HAS A774
HCB1 A635
HHC A775
HHS A775 A904
HKC A775 A904
HKRC A775
HKRS A775
HOEXTER1 A731
HOEXTER2 A731
HOEXTER3 A731
HOEXTER4 A798
HOEXTERKIT A739
HRPC A775
HVEMC A123 F302

I

I1000 C141 C142
IC F602
ICS F602
IL/OL A607 A662
ILS C205
IM30HU0 C111
IM30HU0RL C126
IM30HU1 C111
IM30HU1RL C126
IM30HU2 C111
IM30HU2RL C126
IM30HU3 C111
IM30HU3RL C126
IM30HU5 C111
IM30HU5RL C126
IM30HU6 C111
IM30HU6RL C126
IM30HU8 C111
IM30HU8RL C126
IM30HU9 C111
IM30HU9RL C126
IM30IQ8 C114
IM60HORAIL C127
IM60H1RAIL C127
IM60H2RAIL C127
IM60H3RAIL C127
IM60H5RAIL C127
IM60H6RAIL C127
IM60H8RAIL C127
IM60H9RAIL C127
IM60HU0 C111
IM60HU1 C111
IM60HU2 C111
IM60HU3 C111
IM60HU5 C111
IM60HU6 C111
IM60HU8 C111
IM60HU9 C111
IM60IQ8 C114
IM1000 A607 A716 A718 A903 A904 A905 C116 C131 C134 C136 C137 C139
IM1000 C137
IM1001 C117
IM1002 A707 A708 A709 A710 A711 A712 C116
IM1003 C117
IM1004 C117
IM1005 A906 C116 C131 C132 C134 C135 C136 C137 C138
IM1005N C116 C131 C132 C134 C135 C136 C137 C138
IM1006 C116 C133
IM4120 A718 C107
IM4121 A708 C107 C135 C139
IM4122 C107
IM4123 C107
IM4125 C107
IM4126 C107
IM4128 A709 C107
IM4129 C107
IM4160 A713 C108
IM4160RAIL C126
IM4161 A707 C108
IM4161RAIL C126
IM4162 A710 A712 C108 C138
IM4162RAIL C126
IM4163 C108
IM4163E2C4 A711 C141
IM4163RAIL C126
IM4165 C108 C131
IM4165RAIL C126

IM4166 C108
IM4166RAIL C126
IM4168 A607 A904 A905 A906 C108 C134
IM4168E4OR A711
IM4168RAIL C126
IM4169 A906 C108 C137
IM4169C4 A718
IM4169RAIL C126
IM4200 C108
IM4200RAIL C127
IM4201 C108
IM4201RAIL C127
IM4202 C108
IM4202RAIL C127
IM4203 C108
IM4203RAIL C127
IM4205 C108
IM4205RAIL C127
IM4206 C108
IM4206RAIL C127
IM4208 A902 C108
IM4208RAIL C127
IM4209 C108
IM4209RAIL C127
IM5080 C106
IM5080EKIT A739
IM5080RAIL C126
IM5081 C106
IM5081RAIL C126
IM5082 C106
IM5082RAIL C126
IM5083 C106
IM5083RAIL C126
IM5085 C106
IM5085RAIL C126
IM5086 C106
IM5086RAIL C126
IM5088 C106
IM5088RAIL C126
IM5089 C106
IM5089RAIL C126
IM5100 C106 C136
IM5100RAIL C126
IM5101 A606 A719 C106
IM5101RAIL C126
IM5102 C106
IM5102RAIL C126
IM5103 C106 C136
IM5103RAIL C126
IM5105RAIL C126
IM5106 C106 C132
IM5106RAIL C126
IM5107 A602 A902
IM5107C2 A605

IM5108 C106
IM5108RAIL C126
IM5109 A607 C106
IM5109RAIL C126
IM5200-OR C112
IM5200-ORR C127
IM5201-OR C112
IM5201-ORR C127
IM5202-OR C112
IM5202-ORR C127
IM5203-OR C112 C140
IM5203-ORR C127
IM5205-OR C112
IM5205-ORR C127
IM5206-OR C112
IM5206-ORR C127
IM5208-OR A603 C112
IM5208-ORR C127
IM5209-OR A1003 C112 C140
IM5209-ORR C127
IM6050 A717 C105
IM6050RAIL C128
IM6051 A606 C105
IM6051RAIL C128
IM6052 C105 C145
IM6052RAIL C128
IM6053 A605 C105 C144
IM6053RAIL C128
IM6055 C105 C130 C144
IM6055RAIL C128
IM6056 A606 C105 C144
IM6056RAIL C128
IM6058 A604 A717 C105 C143
IM6058RAIL C128
IM6059 A604 C105 C143
IM6059RAIL C128
IM8120 A713 C107
IM8120RAIL C129
IM8121 C107
IM8121RAIL C129
IM8122 C107
IM8122RAIL C129
IM8123 C107
IM8123RAIL C129
IM8125 C107
IM8125RAIL C129
IM8126 C107
IM8126RAIL C129
IM8128 C107
IM8128C4 A718
IM8128RAIL C129
IM8129 C107
IM8129RAIL C129
IM9080 C109 C143
IM9080RAIL C128
IM9081 C109 C145
IM9081RAIL C128
IM9082 C109
IM9082RAIL C128
IM9083 C109
IM9083RAIL C128
IM9085 C109
IM9085RAIL C128
IM9086 C109
IM9086RAIL C128
IM9088 C109
IM9088RAIL C128
IM9089 C109
IM9089RAIL C128
IM9140 C110
IM9140-OR C112
IM9140ORL C127
IM9140RAIL C128
IM9141 C110
IM9141-OR C112
IM9141ORL C127
IM9141RAIL C128
IM9142 C110
IM9142-OR C112
IM9142ORL C127
IM9142RAIL C128
IM9143 C110
IM9143-OR C112
IM9143ORL C127
IM9143RAIL C128
IM9145 C110
IM9145-OR C112
IM9145ORL C127
IM9145RAIL C128
IM9146 C110
IM9146-OR C112
IM9146ORL C127
IM9146RAIL C128
IM9148 C110 C133
IM9148-OR C112
IM9148ORL C127
IM9148RAIL C128
IM9149 C110
IM9149-OR C112
IM9149ORL C127
IM9149RAIL C128
IM9200 C110
IM9200RAIL C128
IM9201 C110
IM9201RAIL C128
IM9202 C110
IM9202RAIL C128
IM9203 C110
IM9203RAIL C128
IM9205 C110
IM9205RAIL C128
IM9206 C110
IM9206RAIL C128
IM9208 C110
IM9208RAIL C128
IM9209 C110
IM9209RAIL C128
IMAMALGAM C138
IMATRAEXT A707
IMBASPER A708
IMBGKIT A709
IMCEMENT C136
IMCO-FIL3M C224
IMCO-INDNA C224
IMCOMPOSIT C134
IMCOM-SEAL C224
IMCRESTKIT A710
IMCROWN C137
IM-DO120/80 C143
IM-D1110 C143
IM-D1120 C144
IM-D4341/42 C143
IM-D4346 C144
IM-D4355 C144
IM-D4910 C145
IM-D6080 C145
IMDINCOOM C223
IMDINCO1M C223
IMDINCO2M C223
IMDINCO3M C223
IMDINOST A714
IMECC128 C223
IMEDIN131 A906
IMENDO C135
IMEXAM C130
IMEXTKIT A711
IMEXTRACTB C141
IMEXTRACTF C142
IMINSR1000 B307
IMINSRT10 B307
IMINSRT100 B307
IMINSRTSET B307
IMINSRXTB B307
IMIQ38 C114
IMKHAYAT2 A902
IMLATKIT A712
IMMICSUR A713
IMN30HU0 C111
IMN30HU1 C111
IMN30HU2 C111
IMN30HU3 C111
IMN30HU4 C111
IMN30HU5 C111
IMN30HU6 C111
IMN30HU7 C111
IMN30HU8 C111
IMN30HU9 C111
IMN30HU11 C111
IMN60HU0 C111
IMN60HU1 C111
IMN60HU2 C111
IMN60HU3 C111
IMN60HU4 C111
IMN60HU5 C111
IMN60HU6 C111
IMN60HU7 C111
IMN60HU8 C111
IMN60HU9 C111
IMN60HU11 C111
IMN4120 C107
IMN4121 A708 A713 A906 C107 C135 C139
IMN4121 A906
IMN4122 C107
IMN4123 C107
IMN4124 C107
IMN4125 C107
IMN4126 C107
IMN4127 C107
IMN4128 A709 C107
IMN4129 C107
IMN4160 A716 A717 C108
IMN4161 C108
IMN4162 A710 A712 C108 C138
IMN4163 A716 C108
IMN4164 A712 C108
IMN4165 C108 C131
IMN4166 C108
IMN4167 A903 C108
IMN4168 C108 C134
IMN4169 C108 C137
IMN4200 A707 C108
IMN4201 A903 C108
IMN4202 C108
IMN4203 C108
IMN4204 C108
IMN4205 C108
IMN4206 C108
IMN4207 C108
IMN4208 C108
IMN4209 C108
IMN5056E2 A717
IMN5080 A706 C106
IMN5081 A706 C106
IMN5082 C106
IMN5083 C106
IMN5084 A244 C106
IMN5085 C106

IMPSTE1/26 A780
IMPURBA1S6 A780
IMPURBA2S6 A780
IMPURBAN16 A719 A780
IMPURBAN26 A719 A780
IMPURBAN36 A719 A780
IMPURBAN46 A718 A780
IMRESCUE A713
IMRESTOR C131
IMS-1004 D102
IMS-1200H C205
IMS-1200U C205
IMS-1200W C205
IMS-1210 C215
IMS-1210H C215
IMS-1211 C215
IMS-1211H C215
IMS-1212 C215
IMS-1212H C215
IMS-1213 C215
IMS-1213H C215
IMS-1214 C216
IMS-1214H C216
IMS-1215 C216
IMS-1215H C216
IMS-1216 C216
IMS-1216H C216
IMS-1217 C216
IMS-1217H C216
IMS-1218 C204
IMS-1220 C204
IMS-1222 C203 D203
IMS-1222C C203 D203
IMS-1226 C203 D203
IMS-1229 C203
IMS-1230 D203
IMS-1234 C118
IMS-1235 C118
IMS-1236 C218
IMS-1237 C218
IMS-1238 C218
IMS-1239 C218
IMS-1240 C212
IMS-1241 C211
IMS-1243 C214
IMS-1247 C214
IMS-1248 C214
IMS-1251 C214
IMS-1252 C214
IMS-1253 C214
IMS-1254 C214
IMS-1255 C214
IMS-1256 C214
IMS-1257 C214
IMS-1258 C214
IMS-1259 C214
IMS-1260 C214
IMS-1262 C214
IMS-1263 C214
IMS-1264 C214
IMS-1265 C214
IMS-1266 C214
IMS-1267 C214
IMS-1268 C214
IMS-1269 C214
IMS-1270 C214
IMS-1270H C214
IMS-1271 A906 C115 C135
IMS-1271 C135
IMS-1273 A906 C115
IMS-1275 A906 C116 C135
IMS-1275D C116
IMS-1278 C116
IMS-1279 C116
IMS-1280 C118
IMS-1280L C118
IMS-1281 C118
IMS-1281L C118
IMS-1282 C118
IMS-1282L C118
IMS-1283 C118
IMS-1283L C118
IMS-1284 C118
IMS-1284L C118
IMS-1285 C118
IMS-1285L C118
IMS-1286 C118
IMS-1286L C118
IMS-1287 C118
IMS-1287L C118
IMS-1288 C118
IMS-1288L C118
IMS-1289 C118
IMS-1289L C118
IMS-1290N C119
IMS-1291N C119
IMS-1292N C119
IMS-1293N C119
IMS-1294N C119
IMS-1295N C119
IMS-1296N C119
IMS-1297N C119
IMS-1298N C119
IMS-1299N C119
IMS-1345 C218
IMS-1346 C218
IMS-1347 C218
IMS-1348 C218
IMS-1372S A905 A906 C117
C131 C134 C135
C137 C138
IMS-1372SH A713 A718
C117 C136
IMS-1372T C117
IMS-1372TH A714 C117
IMS-1373 C210
IMS-1373H C210
IMS-1374 C210
IMS-1375 C210
IMS-1376 C210
IMS-1377 C210
IMS-1378 C115
IMS-1379 C115
IMS-1400 C146
IMS-1401 C146
IMS-1402 C146
IMS-1403 C146
IMS-1404 C146
IMS-1405 C146
IMS-1406 C146
IMS-1407 C146
IMS-1408 C146
IMS-1409 C146
IMS-1410 C147
IMS-1411 C147
IMS-1412 C147
IMS-1413 C147
IMS-1414 C147
IMS-1415 C147
IMS-1416 C147
IMS-1417 C147
IMS-1418 C147
IMS-1419 C147
IMS-1420 C147
IMS-1421 C148
IMS-1422 C148
IMS-1423 C148
IMS-1424 C149
IMS-1425 C149
IMS-1426 C149
IMS-1427 C148
IMS-1428 C148
IMS-1429 C149
IMS-1430 C149
IMS-1431 C149
IMS-1432 C149
IMS-1433 C147
IMS-1434 C147
IMS-1440 D103
IMS-1440AC D107
IMS-1451 D106
IMS-1452 D106
IMS-1455 C205
IMS-1461 C213
IMS-2004 D102
IMS-2008 D102
IMS-2016 D102
IMS-2024 G100
IMS-2128 G100
IMS-2160 G100
IMS-2215 C216
IMS-2220 C216
IMS-2224 C216
IMS-12810 C118
IMS-12810L C118
IMS-12811 C118
IMS-12811L C118
IMS-12812 C118
IMS-12812L C118
IMS-12813 C118
IMS-12813L C118
IMS-12910N C119
IMS-12911N C119
IMS-12912N C119
IMS-12913N C119
IMS-14011 C146
IMS-14111 C147
IMSINUS C139
IMSS70 C106
IMSS70RAIL C129
IMSS71 C106
IMSS71RAIL C129
IMSS72 C106
IMSS72RAIL C129
IMSS73 C106
IMSS73RAIL C129
IMSS75 C106
IMSS75RAIL C129
IMSS76 C106
IMSS76RAIL C129
IMSS78 C106
IMSS78RAIL C129
IMSS79 C106
IMSS79RAIL C129
IMSUTURE C136
INLINEREF A669
IPZ1 A781
IPZ2 A781
IPZ3 A781
IPZ16 A781
IPZ26 A781
IPZ36 A781
IR A718 A811
IRC-001 C225

J

JED C203
JET C202 D202
JEZ C203
JEZNA C204
JGLUT C207
JHOLD C207
JVAC D202

K

KB3/46 A782
KB5/66 A782
KCK3 A782
KCK36 A782
KGF11X A782
KGF76 A782
KGF86 A782
KGF96 A782
KGF116 A782
KIT-ALEX A1002
KIT-BAKE A606
KIT-MILN A604
KIT-PEDO A603
KIT-SCHWARTZ A906
KIT-VON A904
KIT-WONG A904
KIT-WREN A603
KK15 A783
KK15/16S6 A783
KK15/16SX A783
KK15/16X A783
KK15/166 A783
KK15/169 A783
KK16 A783
KK156 A783
KK166 A783
KKN76 A784
KKN116 A784
KO1 A783
KO1/2X A783
KO1/26 A716 A783
KO1/29 A718 A783
KO12KP3R4X A783
KO12KP3R49 A717 A783
KO12KPO3A6 A717 A783
KO12KPO3A9 A783
KO12KPO3AR A708 A717
 A783
KO12KPO3AX A717 A783
KO12KPO3R9 A717 A783
KO12KPO3RX A708 A717
 A783

KO16 A783
KOERNERKIT A718
KPA A717 A784
KPAD33 A667
KPAD36 A667
KPAD66 A667
KPAX A717 A784
KPQ A822
KRDY1 A784
KRDY2 A784
KS1/26 A784
KSOLT1/26 A784
KSTRIP500 A651
KSTRIP1000 A651
KUSC6 A784

L

LOBL F406
LOC F405
LOCL F405
LOCP F405
LOCPW F405
LODR F406
LOGR F406
LOLV F406
LOWH F406
L3BL F406
L3C F405
L3CP F405
L3CPW F405
L3DR F406
L3GR F406
L3LV F406
L3WH F406
LD1 A1018
LDG2 A1018
LDP A1018
LDT A1018
LENS A305 A306 A308
LPTS A309
LRK C125
LRKN C125
LRKTOOLS C125
LS7 A666
LS8R A666
LSM13 A309
LSM14 A309
LSM30 A309
LSMH6 A309
LSS4 A309
LT C125
LTN C125
LWSS A665

M

M4C A123
M4DC A123
M5C A123 A906
M5DC A123
M1000WHBU F304
M1001CLBU F304
M1002WHWH F304
M1003CLWH F304
M1004WHGR F304
M1005WHPK F304
M1010SUSE F305
M1020ADAP F305
M1030HVSE F305
MAL1 A786 C139
MALALL4KIT A718
MAR-AAC1 A905 A925
MAR-AAC1.5 A925
MAR-AAC2 A926
MAR-AAC3 A926
MAR-AAC.5 A925
MAR-B1 A926
MAR-B2 A926
MAR-B3 A905 A926
MAR-B4 A926
MAR-B5 A904 A927
MAR-C1 A924
MAR-C2 A924
MAR-C3 A905 A924
MAR-C4 A924
MAR-EX1 A905 A921
MAR-EX2 A921
MAR-EX3 A921
MAR-EX4 A921
MAR-EX5 A921
MAR-EX6 A921
MAR-SAC1 A905 A925
MAR-SAC1.5 A925
MAR-SAC2 A925
MAR-SAC3 A925
MAR-SAC.5 A925
MAR-SB1 A926
MAR-SB2 A926
MAR-SB3 A905 A926
MAR-SB4 A926
MAR-SB5 A926
MAR-SC1 A920
MAR-SC2 A920
MAR-SC3 A905 A920
MAR-SC4 A920
MASSKITCASS A605
MB63 A820
MB64 A820
MB67 A820 A905
MB69 A820 A905
MBD030 C212
MBP-C1 A903 A920
MBP-CB1 A903 A927
MBP-E1 A903 A924
MBP-EX1 A903 A922
MBPFIAFL A927
MBPFIAFR A927
MBP-PLG1 A903
MBP-PLG1 A922
MBP-PLG2 A903 A923
MBP-PLG3 A903 A923
MBW A823
MCAF1 A920
MCAF2 A920
MCAF3 A920
MCBLL A904 A927
MCBLM A904 A927
MCBLS A904 A928
MCBRL A904 A927
MCBRM A904 A927
MCBRS A904 A927
MCBUL A903 A928
MCBUM A928
MCBUS A928
MCUPE A308 A709 A712
 A716 A717
MEX1 A922
MEX16 A904
MEXAF1L A922
MEXAF1R A922
MEXAF2L A922
MEXAF2R A922
MGA A786
MGC A786
MGI A786
MH1 A118
MH6 A118 A202 A602 A603
 A604 A605 A606
 A607 A708 A713
 A716 A717 A718 A902
 A904 A906 A1003
 C130 C131 C132 C133
 C134 C135 C136
 C137 C138 C140 C141
 C142 C143 C144
MH6 C135 C137
MH6B A118 A716 A719
MH7 A118 A906
MH8 A118
MH24 A118
MH0175E A119
MH6692K A919
MHE6 A119 A905 A906

MHE6B A119
MHE7 A119
MIEKIT A711
MIM64 A820
MININVKIT A602
MIR3HD A122
MIR3HDE A122
MIR4 A123 A902 A904
 A906 C141 C142
MIR4/3 A123 A202 C135
MIR4/12 A123
MIR4DS A123
MIR4DS/3 A123
MIR4DS/6 A123
MIR4DSHD A122 A202 A606
MIR4DSHD6 A122
MIR4DSHD6E A122
MIR4DSHDE A122
MIR4HD A122 A603 A604
MIR4HD3 A122
MIR4HD3E A122
MIR4HD12 A122
MIR4HD12E A122
MIR4HDE A122
MIR5 A123 A603 A708
 A713 A718 A904
 A905 A1003
MIR5/3 A123 A607 A717
 A1003 C130 C131
 C132 C133 C134
 C136 C137 C138
 C140
MIR5/12 A123
MIR5DS A123 A602
MIR5DS/3 A123
MIR5DS/6 A123
MIR5DSHD A122 C143 C144
MIR5DSHD6 A122
MIR5DSHD6E A122
MIR5DSHDB A120 A719
MIR5DSHDBE A120
MIR5DSHDE A122
MIR5HD A122 A605 A716
 A718
MIR5HD3 A122
MIR5HD3E A122
MIR5HD12 A122
MIR5HD12E A122
MIR5HDB A120 A716
MIR5HDBE A120
MIR5HDE A122 A606
ML02-0127 C206
ML02-0137 C206
MM1 A918
MM2 A918

MM3 A918
MM4 A902 A903 A905 A919
MM5 A905 A906 A919
MM7 A903 A905 A919
MM8 A904 A905 A919
MMR A918
MMRS A918
MMVEL1 A905 A919
MMVEL2 A905 A919
MP48 A787
MP52 C141
MP52 A787 C142
MP54 A718 A787
MPAF1 A924
MPAF2 A924
MPAF3 A924
MRFL A923
MRFR A923
MT26 A628
MT26H A628
MT26H6 A628
MT27 A628
MT27H A628
MT27H6 A628
MT28 A628
MT28H A628
MT28H6 A628
MT29 A628
MT29H A628
MT29H6 A628
MT77/78 A629
MT77/78H A629
MT79/80 A629
MT79/80H A629
MT232TB9 A607
MT232TBM9 A629
MT232TM9 A607 A629
MT233TB9 A607
MT233TBM9 A629
MT233TM9 A607 A629
MT286 A628
MT289 A628
MT296 A628
MT299 A628
MT54897 A628
MT54907 A628

N

NASTACR A607 A663
NH5020 A789
NH5020M A787
NH5020R A789
NH5021 A789

NH5021M A787
NH5021RC A789 A902 A903
NH5024 A606 A789
NH5024CORT A713 A788
NH5024R A716 A789
NH5024RC A790
NH5024SIM A718 A790
NH5032 A790
NH5034 A790 A904
NH5036 A790
NH5037 A712 A790 A905
NH5038 A710 A790 A904
 A905 C139
NH5038L A790
NH5042 A718 A791
NH5044 A791
NH5046 A791
NH5050 A791
NH5052 A791 A903
NH5068 A791
NH5074 A791 A904
NH5074E A791
NH5082 A792
NH5084 A792
NH5092 A792
NHC A792
NHCV A788
NHCV18 A788
NHCW A707 A708 A709
 A712 A718 A792
 C141 C142
NHD A793
NHDCPV A788
NHDCPVN A716 A719 A788
NHDPV A716 A717 A788
 A905
NHDPVN A788
NHGILFINE A792
NHHB A709 A793
NHLBPSB A718 A792
NHLBPSE A792
NHM A793
NHM-5025R A788
NHM-5026R A717 A788
NHM-5027 A717 A788
NHM-5028 A789
NHMH A711 A793
NHOH A793
NHLSCHLEE A788
NHTMBH A789
NHW A793
NIPRO A848
NIPS A848
NN3BL F509
NN4BL F509

NP3BL F509
NP3WH F509
NP4BL F509
NP4WH F509
NP5BL F509
NP5WH F509
NSP-400 C221
NSP-405 C221
NSP-410 C221
NSP-420 C221
NSP-430 C221
NTEIK A607
NTIPC A607 A663
NTIPK A607 A663

O

OC C222
OCS C222
OK5A A648
ORTHOKIT1 A1003
ORTHOKIT2 A1003
ORTHOKIT3 A1003
OSS6518S A794
OSS6519CS A794
OSS6520S A794
OSS6521CS A794
OSTJ08 A794
OSTMGRIF A714 A796
OSTMPU27 A714 A795
OSTMPU27A A714 A795
OSTMPU32 A714 A795
OSTMPU32A A714 A795
OSTMPU37 A714 A795
OSTMPU37A A714 A795
OSTMPU42 A714 A795
OSTMPU42A A714 A795
OSTMPU50 A714 A795
OSTMPU50A A714 A795
OSTMSH27 A714 A796
OSTMSH27A A714 A796
OSTMSH32 A714 A796
OSTMSH32A A714 A796
OSTMSH37 A714 A796
OSTMSH37A A714 A796
OSTMSH42 A714 A796
OSTMSH42A A714 A796
OSTMSH50 A714 A796
OSTMSH50A A714 A796
OSTMSP27 A714 A796
OSTMSP27A A714 A796
OSTMSP32 A714 A796
OSTMSP32A A714 A796
OSTMSP37 A714 A796

OSTMSP37A A714 A796
OSTMSP42 A714 A796
OSTMSP42A A714 A796
OSTMSP50 A714 A796
OSTMSP50A A714 A796
OSTONUT A796
OSTPAL1 A710 A795
OSTPAL2 A710 A795
OSTPAL3 A710 A795
OSTPAL4 A710 A795

P

P1 A798
P1H6 A798
P1N A109
P1N6 A109
P2 A798
P2N A109
P2N6 A109
P3 A799
P3/4 A110
P3/46 A110
P3N A110
P5 A801
P8D A799
P8D6 A799
P9 A800 A904 A905
P9A A800
P9A6 A716 A800
P9H A800
P9H6 A800
P9/PA A800
P9/PA6 A800
P9X A707 A709 A710 A711 A718 A800
P12/11.5B6 A109
P12S A797
P12S6 A797
P14 A797
P14X A797
P15 A798
P15/11.5B6 A109
P16 A798
P20 A799
P20SIC A799
P20SIC6 A799
P23 A718 A805 A903 A904 C139
P24G A799
P24G6 A799
P24GSIC A799
P24GSIC6 A799
P24GSP A799
P24GSP6 A799
P24GSPX A799
P26 A798
P26G A107
P26G6 A107
P36 A799
P96 A707 A709 A710 A711 A800 C141 C142
P146 A797
P149 A797 A904
P156 A798
P166 A798
P206 A799
P1496 A797
P13872 G101
P63884 G101
PAPREF A669
PBQ A800
PBQ6 A800
PBTPB A105
PBTPG A105
PBTPKIT12 A105 A202
PBTPW A105
PC2130 F406
PCC F203
PCNC15/126 A718
PCORTLINI A605
PCP2 A106
PCP3CH A110
PCP8 A106
PCP10 A106
PCP11 A106
PCP11.5B A109
PCP11.5B6 A109
PCP11.5B7 A109
PCP11.5B8 A109
PCP12 A106 A906
PCP12/11.5 A109 A202
PCP12/QOW6 A110
PCP15/11.5 A109 A202
PCP18 A107
PCP26 A106
PCP86 A106
PCP106 A106
PCP107 A106
PCP108 A106
PCP116 A106 A717
PCP117 A106
PCP118 A106
PCP126 A106 A606 A904 C130 C132 C133 C137
PCP127 A106
PCP128 A106
PCP186 A107
PCP188 A107
PCP6500 A781
PCP65006 A710 A781
PCPGF/W A110
PCPGF/W6 A110
PCPMDBIU A107
PCPNT2 A108
PCPNT2W A108
PCPNT11 A108
PCPNT11.5B A109
PCPNT12 A108
PCPNT15 A108
PCPNT26 A108
PCPNT27 A108
PCPNT28 A108
PCPNT126 A108
PCPNT156 A108
PCPNTOW A108
PCPNTOW6 A108
PCPNTOW8 A108
PCPQOW11.5 A109
PCPS36 A110
PCPUNC12 A107
PCPUNC15 A107
PCPUNC15CH A716 A719
PCPUNC126 A107 C143
PCPUNC127 A107
PCPUNC128 A107
PCPUNC156 A107 A713 A905
PCPUNC157 A107
PCPUNC158 A107
PCUPM A308
PCV11KIT6 A104
PCV11KIT12 A104
PCV11PT A104
PCV12KIT6 A104
PCV12KIT12 A104
PCV12PT A104
PCVNCKIT6 A104 C139
PCVNCKIT12 A104
PCVO12PT A104
PCVOKIT6 A105 A202
PCVPROMONC C145
PCVUNC12PT A104
PCVWKIT6 A105
PCVWPT A105
PDCBL F106
PDCWH F106
PDEMIRELS6 A800
PDONOS A801
PEREUR A806
PEREURX A806
PESIM1 A716 A780
PESIM16 A716 A780
PFI1 A618
PF18A A612
PF18A6 A607 A612
PF18ABK6 A902 A903 A923
PFI11 A615
PFI16 A618
PFI49 A617
PFI116 A615
PFI179 A615
PFI6 A612
PFI66 A612
PFI67 A612
PFI68 A612
PFIAB1 A612
PFIAB2 A612
PFIAB16 A612
PFIBEQ1 A618
PFIBEQ17 A618
PFIDD1/2 A605 A616
PFIDD1/28 A605 A616
PFIDD3/4 A605 A616
PFIDD3/48 A605 A616
PFIDD5/6 A605 A616
PFIDD5/68 A605 A616
PFIDD7/8 A605 A616
PFIDD7/88 A605 A616
PFIDD9/10 A605 A616
PFIDD9/108 A605 A616
PFIDDCASS A605
PFIDDCASS8 A605
PFIDP6 A629
PFIDPT6 A616
PFIG A615
PFIG4/5 A612
PFIGML1 A617
PFIGML2 A617
PFIGML26 A617 A905
PFIHF1 A617
PFIHF2 A617
PFIHS16 A666
PFIHS26 A666
PFIKOT1 A622
PFIKOT2 A602 A619
PFITR1/2 A616
PFIW1 A616
PFIW3 A612
PFIW36 A612
PFIW38 A612
PFIWDS1 A616 A617 A710 A904
PFIWDS1MK A801
PFIWDS1MKX A716 A718 A801
PFIWDS1S6 A801
PFIWDS1X A801
PFIWDS2 A617

PFIWDS3 A617
PFIWDS16 A616 A617 A710
PFIWDS26 A617
PFN A801
PGF A107
PGF6 A107
PGF/W A110
PGF/W6 A110
PGF/W7 A110
PGF/W8 A110
PGR1 A801
PH1 A805 A904
PH2 A801
PH2KALLA A801
PH6 A105
PH26 A801
PH26M A801 A905
PHO6 A105
PICH A635
PICH6 A635 C131 C138
PICH8 A635
PINT10 A635
PINT11 A635
PJO/1 A725
PJO/2 A725
PJO/2M6 A716 A725
PJO/3 A725
PJO/3M6 A716 A725
PJO/16 A712 A716 A725
PJO16 A716
PJO/26 A725
PJO/36 A725
PK2-5080RL C122
PK2-5081RL C122
PK2-5082RL C122
PK2-5083RL C122
PK2-5084RL C122
PK2-5085RL C122
PK2-5086RL C122
PK2-5087RL C122
PK2-5088RL C122
PK2-5089RL C122
PK2-5100RL C122
PK2-5101RL C122
PK2-5102RL C122
PK2-5103RL C122
PK2-5104RL C122
PK2-5105RL C122
PK2-5106RL C122
PK2-5107RL C122
PK2-5108RL C122
PK2-5109RL C122
PK2-6050RL C123
PK2-6051RL C123
PK2-6052RL C123
PK2-6053RL C123
PK2-6054RL C123
PK2-6055RL C123
PK2-6056RL C123
PK2-6057RL C123
PK2-6058RL C123
PK2-6059RL C123
PK2-50811R C122
PK2-51011R C122
PK2-60511R C123
PK-30HU0RL C120
PK-30HU1RL C120
PK-30HU2RL C120
PK-30HU3RL C120
PK-30HU4RL C120
PK-30HU5RL C120
PK-30HU6RL C120
PK-30HU7RL C120
PK-30HU8RL C120
PK-30HU9RL C120
PK-30HU11R C120
PK-60H0RL C123
PK-60H1RL C123
PK-60H2RL C123
PK-60H3RL C123
PK-60H4RL C123
PK-60H5RL C123
PK-60H6RL C123
PK-60H7RL C123
PK-60H8RL C123
PK-60H9RL C123
PK-60H11RL C123
PK-4120RL C120
PK-4121RL C120
PK-4122RL C120
PK-4123RL C120
PK-4124RL C120
PK-4125RL C120
PK-4126RL C120
PK-4127RL C120
PK-4128RL C120
PK-4129RL C120
PK-4160RL C121
PK-4161RL C121
PK-4162RL C121
PK-4163RL C121
PK-4164RL C121
PK-4165RL C121
PK-4166RL C121
PK-4167RL C121
PK-4168RL C121
PK-4169RL C121
PK-4200RL C121
PK-4201RL C121
PK-4202RL C121
PK-4203RL C121
PK-4204RL C121
PK-4205RL C121
PK-4206RL C121
PK-4207RL C121
PK-4208RL C121
PK-4209RL C121
PK-8120RL C123
PK-8121RL C123
PK-8122RL C123
PK-8123RL C123
PK-8124RL C123
PK-8125RL C123
PK-8126RL C123
PK-8127RL C123
PK-8128RL C123
PK-8129RL C123
PK-9080RL C124
PK-9081RL C124
PK-9082RL C124
PK-9083RL C124
PK-9084RL C124
PK-9085RL C124
PK-9086RL C124
PK-9087RL C124
PK-9088RL C124
PK-9089RL C124
PK-9140OR C124
PK-9140RL C124
PK-9141OR C124
PK-9141RL C124
PK-9142OR C124
PK-9142RL C124
PK-9143OR C124
PK-9143RL C124
PK-9144OR C124
PK-9144RL C124
PK-9145OR C124
PK-9145RL C124
PK-9146OR C124
PK-9146RL C124
PK-9147OR C124
PK-9147RL C124
PK-9148OR C124
PK-9148RL C124
PK-9149OR C124
PK-9149RL C124
PK-9200RL C125
PK-9201RL C125
PK-9202RL C125
PK-9203RL C125
PK-9204RL C125
PK-9205RL C125
PK-9206RL C125
PK-9207RL C125
PK-9208RL C125
PK-9209RL C125
PK-41211RL C120
PK-41611RL C121
PK-42011RL C121
PK-81211RL C123
PK-90811RL C124
PK-91411OR C124
PK-91411RL C124
PK-92011RL C125
PKE-4120R C120
PKE-4121R C120
PKE-4122R C120
PKE-4123R C120
PKE-4124R C120
PKE-4125R C120
PKE-4126R C120
PKE-4127R C120
PKE-4128R C120
PKE-4129R C120
PKE-4160R C121
PKE-4161R C121
PKE-4162R C121
PKE-4163R C121
PKE-4164R C121
PKE-4165R C121
PKE-4166R C121
PKE-4167R C121
PKE-4168R C121
PKE-4169R C121
PKE-4200R C121
PKE-4201R C121
PKE-4202R C121
PKE-4203R C121
PKE-4204R C121
PKE-4205R C121
PKE-4206R C121
PKE-4207R C121
PKE-4208R C121
PKE-4209R C121
PKE-8120R C123
PKE-8121R C123
PKE-8122R C123
PKE-8123R C123
PKE-8124R C123
PKE-8125R C123
PKE-8126R C123
PKE-8127R C123
PKE-8128R C123
PKE-8129R C123
PKE-41211R C120
PKE-41611R C121
PKE-42011R C121
PKE-81211R C123
PKE-OSOR C125

- PKE-OS1R** C125
- PKE-OS2R** C125
- PKE-OS3R** C125
- PKE-OS4R** C125
- PKE-OS5R** C125
- PKE-OS6R** C125
- PKE-OS7R** C125
- PKE-OS8R** C125
- PKE-OS9R** C125
- PKE-OS11R** C125
- PKN1** A802
- PKN16** A802
- PKN152** A802
- PKN152SX** A802
- PKN152X** A802
- PKN1526** A802
- PK-ORTL4L** C121
- PK-ORTL8L** C121
- PK-ORTL9L** C121
- PK-ORTS4L** C122
- PK-ORTS8L** C122
- PK-ORTS9L** C122
- PK-OS0RAIL** C125
- PK-OS1RAIL** C125
- PK-OS2RAIL** C125
- PK-OS3RAIL** C125
- PK-OS4RAIL** C125
- PK-OS5RAIL** C125
- PK-OS6RAIL** C125
- PK-OS7RAIL** C125
- PK-OS8RAIL** C125
- PK-OS9RAIL** C125
- PK-OS11RAI** C125
- PKT1** A670
- PKT2** A670
- PKT3** A670
- PKT3R** A650 A670
- PKT3R6** A650
- PKT3RM6** A906
- PKT4** A670
- PKT5** A670
- PKT36** A670
- PLG0/1** A637
- PLG0/1NS** A637
- PLG0/1NS6** A637
- PLG0/16** A637 A906 C131 C138
- PLGOT** A603 A638
- PLG1/2** A636
- PLG1/2NS** A636
- PLG1/2NS6** A636
- PLG1/26** A636 C131 C138
- PLG1M** A637
- PLG1SIM** A639
- PLG2M** A638
- PLG2M6** A638
- PLG2T** A638
- PLG3T** A638
- PLG4M** A638
- PLG9/10** A638
- PLG11/12** A638
- PLG153** A638
- PLG154** A638
- PLG5169** A638
- PLGA1/2** A636
- PLGA1/28** A636
- PLGBK6** A902 A903
- PLGGR1** A773
- PLGGR1S6** A773
- PLGGR1X** A712 A773
- PLGH1** A636
- PLGH2** A637
- PLGH3** A637
- PLGH4** A637
- PLGH16** A636
- PLGH18** A636
- PLGH26** A637
- PLGJO/4** A773
- PLGJO/4X** A716 A773
- PLGJO/46** A719 A773
- PLGJO/56** A716 A773
- PLGKOT1** A621
- PLGKOT2** A602 A621
- PLGLABANC6** A773
- PLGLABANCX** A773
- PLGMO2** A637
- PLGOR1** A638
- PLGOR2** A638
- PLGOR3** A639
- PLGOR4** A639
- PLGOR18** A638
- PLGOR26** A638
- PLGRF1** A923
- PLGRF2** A923
- PLGROMP1X** A773
- PLGROMP2X** A773
- PLGS2** A637
- PLGSPO** A637
- PLGTAHM** A773
- PLGVEL56** A902 A903 A923
- PLGW1** A639
- PLGW2** A639
- PLGW3** A639
- PLPK** A1018
- PMALO** A802
- PMB** A107
- PMB6** A107
- PMEDGES** A719 A728
- PMEKIT** A719
- PMKIT** A719
- PMNANOAS** A719 A785
- PMNANOSS** A719 A785
- PMP7002** A772
- PMP1** A709 A772
- PMP16** A772
- PMP1E** A772
- PMP1S** A772
- PMP1S6** A772
- PMP1X** A709 A712 A772
- PMPRODIGYS** A719 A732
- PMSPLITSX** A719 A802
- PO** A108
- PO6** A108
- POW** A108
- POW6** A108
- POWCOMPKIT** A244
- PP25** A802
- PP5590SIM** A802
- PP5689** A718
- PPAEL** A717 A803
- PPAELA** A717 A803
- PPAELAS6** A803
- PPAELASX** A803
- PPAELAX** A717 A803
- PPAELP** A803
- PPAELPSX** A803
- PPAELPX** A717 A803
- PPAELS6** A803
- PPAELSX** A803
- PPAELX** A717 A803
- PPBUH2M2X** A803
- PPBUH2MX** A803
- PPBUSE1/26** A803
- PPBUSE1/36** A709 A803
- PPBUSE2/36** A709 A725
- PPBUSER** A803
- PPBUSER1/2** A725
- PPBUSER1/26** A725
- PPBUSER2/3** A725
- PPBUSER6** A709 A713 A803 A904 C139
- PPBUSER12X** A725
- PPBUSER13X** A709
- PPBUSER23X** A709 A725
- PPBUSERSX** A803
- PPBUSERX** A709 A713 A803
- PPIS** A772
- PPLABAN2S6** A804
- PPLABANC3X** A804
- PPLABANC26** A804
- PPLABANC36** A804
- PPLABANCA** A803
- PPLABANCA2** A804
- PPLABANCA3** A804
- PPLABANCA6** A803 A905
- PPR3** A804
- PPR3/9A** A804
- PPR3/9A6** A804 A904
- PPR3M** A804
- PPR3S** A804
- PPR3S6** A710 A719 A804 A902
- PPR3X** A708 A712 A716 A718 A804
- PPR36** A606 A708 A804
- PPS10KIT6** A106
- PPS10KIT12** A106
- PPS10PT** A106
- PPS12KIT6** A106
- PPS12KIT12** A106
- PPS12PT** A106
- PPSG12PT** A105
- PPSGKIT6** A105 A202
- PPSPAHR6** A804 A905
- PPSPROMO10** A106
- PPSPROMO12** A106
- PPSTEIG** A717 A804
- PQ2N** A109
- PQ2N6** A109 C143
- PQ2N7** A109
- PQ2N8** A109
- PQO** A107
- PQO6** A107
- PQOW** A107
- PQOW6** A107
- PQOW7** A107
- PQOW8** A107
- PQOW11.5B6** A109
- PQW** A107
- PQW6** A107
- PQW7** A107
- PQW8** A107
- PROCLHDL** A669
- PROCLHDLS** A669
- PROG** A606 A669
- PROGS** A606 A669
- PROLUX1** A715
- PROLUX1X** A715
- PROLUX2** A715
- PROLUX2X** A715
- PROLUX3** A715
- PROLUX3X** A715
- PROLUX4** A715
- PROLUX4X** A715
- PROLUX5** A715
- PROLUX5X** A715
- PROLUX6** A715
- PROLUX7** A715
- PROLUX8** A715

PROLUX9 A715
PROLUXKIT4 A715
PROLUXSPADES A715
PROLUXSPADESX A715
PSN271V A836
PSN302V A836
PSN303V A836
PSN304V A836
PSN385C A836
PSN385V A836
PSN386C A836
PSN386V A836
PSN387V A836
PSN388V A836
PSN389V A836
PSN392V A836
PSN393V A836
PSN397V A836
PSN421V A836
PSN422V A836
PSN460V A836
PSN489V A836
PSN490V A836
PSN492V A836
PSN493V A836
PSN494V A836
PSN510FA A836
PSN515FA A836
PSN525FA A836
PSN530FA A836
PSN535FA A836
PSN540FA A836
PSN585FA A836
PSN612A A836
PSN631S A837
PSN632S A837
PSN634C A836
PSN635C A836
PSN636C A836
PSN640S A837
PSN641S A837
PSN661N A837
PSN662N A837
PSN681S A837
PSN682S A837
PSN683S A837
PSN684S A837
PSN686A A836
PSN687C A836
PSN698N A837
PSN719S A837
PSN723A A836
PSN723V A836
PSN724V A836
PSN733S A837

PSN734S A837
PSN736S A837
PSN737S A837
PSN774A A836
PSN870S A837
PSN871S A837
PSN872S A837
PSN952S A837
PSN953S A837
PSN1628S A837
PSN1644A A836
PSN1654C A836
PSN1816C A836
PSN6953L A837
PSN7342S A837
PSN7343S A837
PSN7762S A837
PSN7763S A837
PSN7764S A837
PSN7771A A836
PSN7772S A837
PSN7773L A837
PSN7773P A837
PSN8245P A837
PSN8384P A837
PSN8385P A837
PSN8614P A837
PSN8660P A837
PSN8661P A837
PSN8683P A837
PSN8695P A837
PSN8696P A837
PSN8697P A837
PSN8698P A837
PSN8756P A837
PSNH810A A836
PSNH820A A836
PSNH821A A836
PSNH822A A836
PSNPTFE1 A837
PSNPTFE2 A837
PSNPTFE3 A837
PSNPTFE4 A837
PSNPTFE5 A837
PSNPTFE6 A837
PSNPTFE7 A837
PSNPTFE8 A837
PSNPTFE9 A837
PSNPTFE10 A837
PSNPTFE11 A837
PSNPTFE12 A837
PSNR683L A837
PSNR698L A837
PSNR7772L A837
PSNU202C A836

PT1 A711 A806
PT1X A718 A806
PT2 A711 A806
PT2X A806
PT3 A806
PT3X A806
PT4 A806
PT4X A806
PT5 A806
PT5X A806
PT6 A806
PT6X A806
PTAA A721
PTC F508
PTFS A721
PTFSB A721
PTI7 A714
PTI-0008 C125
PTI8 A714
PTI9 A714
PTI10 A714
PTI-0029 C125
PTI-0050 C125
PTIH A714 A806
PTIKIT A714
PTISB A838
PTNFM1 A786
PTROM16 A805
PTRTA A786
PTRTC A721 A786
PTRTCL A721
PTRTI A786
PTS A305 A306 A308
PTS-IND A308 C143 C144 C145
PW A108
PW6 A108
PW7 A108
PW8 A108
PWD A110
PWD6 A110
PWILL A804

Q

Q55172 G102
Q85084 G103
Q86984 G102
Q89072 G103

R

R1 A813
R1A A813

R3H A813
R4 A813
R4A A813
R5 A812
R5S A812
R15 A813
R18M A812
RASP A777 C139
RAYKIT A716
RBey A718 A814
RBL A718 A814
RBL45 A814
RBL90 A814
RBOE A814
RBOEC A814
RCDM2 C135
RCDM2 C135
RCP1/3 A906 A935 C135
RCP1/3X A902 A935
RCP5/7 A906 A935 C135
RCP5/7 C135
RCP5/7X A902 A935
RCP8 A906 A938
RCP8-1/2 A938
RCP8-1/2A A937
RCP8A A937
RCP9 A906 A938
RCP9-1/2 A938
RCP9-1/2A A937
RCP9/11 A906 A935 C135
RCP9/11X A902 A935
RCP9A A937
RCP10 A906 A938
RCP10-1/2 A938
RCP10-1/2A A937
RCP10A A937
RCP11 A906 A938
RCP11-1/2 A938
RCP11-1/2A A937
RCP11A A937
RCP12 A938
RCP12A A937
RCP30 A935
RCP40 A935
RCP50 A935
RCP60 A935
RCPGL1 A906 A935 A936 C135
RCPGL1 C135
RCPGL1X A902 A935
RCPGL16 A936
RCPGL17 A936
RCPL1 A936
RCPL2 A937
RCPL3 A937

RCPL4 A937
RCPM1/2 A906 A936
RCPM3/4 A906 A936
RCPSL172 A936
RCPSL275 A936
RCPSL376 A936
RCPSL478 A936
RCPSL577 A936
RCS0A A934
RCS0A A934
RCS0P A934
RCS00P A934
RCS3 A934
RCS3NT A933
RCS25NT A933
RCS25SNT A933
RCS30 A932
RCS40 A932
RCS40SNT A933
RCS50 A932
RCS60 A932
RCSD11 A931
RCSD11NT A902 A906
 A933 C135
RCSD11S A931
RCSD11T A906 A931
RCSD11T6 A931
RCSD11TNT A933
RCSD11TS A932
RCSD11TSNT A933
RCSD11TSX A932
RCSD11TX A931
RCSD11X A931
RCSD116 A931
RCSGP1 A931
RCSGP1X A931
RCSGP2 A934
RCSGP3 A934
RCSGP16 A931
RCSMA57 A934
RCSMA57NT A933
RCSMA57X A932
RCSW1S A931
RCSW2S A931
RDAF6 A905 A914 A916
RDCF5 A916
RDCKITX A913
RDCMO A908
RDCM00 A909 A914
RDCM0X A908
RDCM00X A909
RDCM1 A905 A906 A908
 A914 C135
RDCM1 C135

RDCM1A A908
RDCM1AX A908
RDCM1X A908
RDCM2 A906 A908 A914
RDCM2A A908
RDCM2AS A908
RDCM2ASX A908
RDCM2AX A908 A913
RDCM2X A908
RDCM3 A906 A912
RDCM3X A912
RDCM4 A905 A911
RDCM4X A911
RDCM5 A911
RDCM5X A911
RDCM6 A907
RDCM6X A907
RDCM7 A912 A914
RDCM7A A912
RDCM7AX A912
RDCM7X A912
RDCM8 A905 A911 A914
RDCM8A A909 A914
RDCM8AD A909
RDCM8ADX A909
RDCM8AX A909
RDCM8X A911
RDCM9 A905 A906 A907
 A914 C135
RDCM9S A907
RDCM9SX A907
RDCM9X A907
RDCM10 A909
RDCM10X A909
RDCM11 A910
RDCM11X A910
RDCM12A A912
RDCM12AX A912 A913
RDCM13A A913
RDCM13AX A913
RDCM14 A910
RDCM14A A910 A914
RDCM14AX A910
RDCM14X A910 A913
RDCM18 A910
RDCM18X A910
RDCM24 A912
RDCM24X A912
RDCM25 A912
RDCM25X A912
RDCM26 A913
RDCM26N A905 A906
 A911 C135
RDCM26NX A911

RDCM26X A913
RDCM27 A910
RDCM27N A908
RDCM27NX A908 A913
RDCM27X A910
RDCM28 A913
RDCM28X A913
RDCM29 A909
RDCM29X A909
RDCM30 A911
RDCM30X A911
RDCM31 A911
RDCM31X A911
RDCM56 A910
RDCM56S A910
RDCM56SX A910
RDCM56X A910
RDCM106L A908
RDCM106LX A908
RDCM106R A908
RDCM106RX A908
RDCM201 A911
RDCM201X A911
RDCM205 A911
RDCM205X A911
RDCM209 A909
RDCM209X A909
RDCM212 A905 A906
 A907 A914
RDCM212SA A907
RDCM212SAX A907
RDCM212X A907 A913
RDCMB4 A907
RDCMB4X A907
RDCMW2 A906 A908
RDCMW2X A908
RDCMW3 A912
RDCMW3X A912
RDCMW4 A911
RDCMW4X A911
RDCMW7 A912
RDCMW7X A912
RDCMW8A A603 A905
 A906 A909
RDCMW8AX A909 A913
RDCMW14A A910
RDCMW14AX A910
RDCOB A913 A914 A916
 C117
RDCSET A914
RDCSET7 A914
RDF A906 A914 A916 C135
RDF4 A905 A916
RDKIT A914

RDP A914 A915
RDPA A906 A915
RDTFDI A914 A915
RDTUNIV A914 A915
RECPERIO-KIT A203
RECPSOLO-KIT A203
RESTOREITKIT A605
RF A711 A814
RF45 A939
RF90 A940
RFP A940
RFSTR A939
RKN A813
RMF A713 A716 A814
RMF90 A814
RR20BI C208
RR20READER C208
RSCD11T A906
RSMID1 A811
RSMID2 A811

S

S1 C141
S1 A718 A831 C142
S1L A831
S2 A831
S2L A831
S3 A831
S4 A831
S5 A831
S6 A831
S7 A831
S8 A831
S9 A832
S10 A829
S10SC A829
S11 A832
S11/12S6 A238
S12 A832
S13 A832
S13K/13KL A725
S13K/13KL6 A713 A725
S13K/13KL9 A713 A725
S13K/13KLX A725
S13K/TG A725
S13K/TG6 A708 A718 A725
S13K/TG9 A725
S13K/TGS6 A725
S13K/TGX A708 A725
S13S A832 C136
S14 A828
S14SC A828 A902
S14SCX A716 A828

- S15** A832
- S16** A708 A709 A711
A712 A718 A828
- S16SC** A707 A718 A828
- S16SCX** A707 A708 A709
A711 A712 A828
- S17** A716 A828 A905 A906
- S17SC** A828
- S17SCX** A828
- S18** A828 A904 C131 C134
C137
- S18SC** A719 A828
- S18SCX** A828
- S19SCX** A828
- S20SCX** A716 A828 A903
- S21** A832
- S22** A832
- S23** A832
- S31** A717 A834
- S40** A833
- S44/45** A726
- S44/456** A726
- S103/1066** A240
- S104/1056** A240
- S107/108S** A240
- S107/1086** A240
- S107/1087** A240
- S107/1088** A240
- S129** A233
- S204** A232
- S204S** A232
- S204S6** A232
- S204S7** A232
- S204S8** A232
- S204S9E2** A203 A232
A606 C133
- S204SC8E2** A232 A237
- S204SCCHE2** A719
- S204SD2** A232
- S204SD6** A232 A905
- S204SD7** A232
- S204SD8** A232
- S204SD9E2** A232
- S204SDC8E2** A232 A237
- S204SDG9E2** A232
- S204SDXE2** A232
- S204SG9E2** A232
- S204SXE2** A232
- S411/412** A226
- S413/414** A226
- S1296** A233
- S2046** A232
- S5001** A829 A904
- S5002** A718 A829
- S5009** A829
- S5011** A829
- S5012** A829
- S5054** A830
- S5055** A712 A830 A905
- S5056** A830
- S5057** A830
- S5069** A830
- S5080** A717 A830
- S5081** A830
- S5082** A830
- S5083** A830
- S5095** A829
- SANAF3 (P13872)** G101
- SANAFXL23 (P63884)** G101
- SANL (Q89072)** G103
- SANLS (Q55172)** G102
- SANXL2 (Q85084)** G103
- SANXLS2 (Q86984)** G102
- SAS1/2** A212
- SAS1/2C8E2** A237
- SAS1/2C8E2** A212
- SAS1/2R** A212
- SAS1/2R6** A212
- SAS1/2R7** A212
- SAS1/2R8** A212
- SAS1/2R9E2** A212 C144
- SAS1/2RC8E2** A212
- SAS1/2RXE2** A212
- SAS1/2XE2** A202 A212
- SAS1/26** A212
- SAS1/27** A212
- SAS1/28** A212
- SAS1/29E2** A218
- SAS1/29E2** A212 C133
C143 C144
- SAS3/4** A212
- SAS3/4C8E2** A237
- SAS3/4C8E2** A212
- SAS3/4R** A212
- SAS3/4R6** A212
- SAS3/4R7** A212
- SAS3/4R8** A212
- SAS3/4R9E2** A212
- SAS3/4RC8E2** A212
- SAS3/4RXE2** A212
- SAS3/4XE2** A212
- SAS3/46** A212
- SAS3/47** A212
- SAS3/48** A212
- SAS3/49E2** A212
- SAS5/6** A212
- SAS5/6C8E2** A237
- SAS5/6C8E2** A212
- SAS5/6R** A212
- SAS5/6R6** A212
- SAS5/6R7** A212
- SAS5/6R8** A212
- SAS5/6R9E2** A212
- SAS5/6RC8E2** A212
- SAS5/6RXE2** A212
- SAS5/6XE2** A212
- SAS5/66** A212
- SAS5/67** A212
- SAS5/68** A212
- SAS5/69E2** A212
- SAS7/8** A213
- SAS7/8C8E2** A237
- SAS7/8C8E2** A213
- SAS7/8R** A213
- SAS7/8R6** A213
- SAS7/8R7** A213
- SAS7/8R8** A213
- SAS7/8R9E2** A213
- SAS7/8RC8E2** A213
- SAS7/8RXE2** A213
- SAS7/8XE2** A202 A213
- SAS7/86** A213
- SAS7/87** A213
- SAS7/88** A213
- SAS7/89E2** A213
- SAS11/12** A213
- SAS11/12C8E2** A237
- SAS11/12C8E2** A213
- SAS11/12R** A213
- SAS11/12R6** A213
- SAS11/12R7** A213
- SAS11/12R8** A213
- SAS11/12R9E2** A213
- SAS11/12RC8E2** A213
- SAS11/12RXE2** A213
- SAS11/12XE2** A213
- SAS11/14** A213
- SAS11/14C8E2** A213
- SAS11/14XE2** A213
- SAS11/126** A213
- SAS11/127** A213
- SAS11/128** A213
- SAS11/129E2** A213
- SAS11/146** A213
- SAS11/147** A213
- SAS11/148** A213
- SAS11/149E2** A213
- SAS12/13** A213
- SAS12/13C8E2** A213
- SAS12/13XE2** A213
- SAS12/136** A213
- SAS12/137** A213
- SAS12/138** A213
- SAS12/139E2** A213
- SAS13/14** A213
- SAS13/14C8E2** A213 A237
- SAS13/14R** A213
- SAS13/14R6** A213
- SAS13/14R7** A213
- SAS13/14R8** A213
- SAS13/14R9E2** A213
- SAS13/14RC8E2** A213
- SAS13/14RXE2** A213
- SAS13/14XE2** A213
- SAS13/146** A213
- SAS13/147** A213
- SAS13/148** A213
- SAS13/149E2** A213
- SAS15/16** A213
- SAS15/16C8E2** A213 A237
- SAS15/16R** A213
- SAS15/16R6** A213
- SAS15/16R7** A213
- SAS15/16R8** A213
- SAS15/16R9E2** A213
- SAS15/16RC8E2** A213
- SAS15/16RXE2** A213
- SAS15/16XE2** A213
- SAS15/166** A213
- SAS15/167** A213
- SAS15/168** A213
- SAS15/169E2** A213
- SB1** A235
- SB2/3** A235
- SB2/36** A235 A718
- SB4** A235
- SB5/6** A235
- SBH1/2** A223
- SBH1/2C8E2** A223 A237
- SBH1/2G9E2** A223
- SBH1/2R** A223
- SBH1/2R6** A223
- SBH1/2R7** A223
- SBH1/2R8** A223
- SBH1/2R9E2** A223
- SBH1/2RC8E2** A223 A237
- SBH1/2RXE2** A223
- SBH1/2USC9E2** A223
- SBH1/2USCXE2** A223
- SBH1/2XE2** A223
- SBH1/26** A223
- SBH1/27** A223
- SBH1/28** A223
- SBH1/29E2** A223
- SBH5/6** A223
- SBH5/6C8E2** A223 A237
- SBH5/6G9E2** A223
- SBH5/6R** A223
- SBH5/6R6** A223
- SBH5/6R7** A223

- SBH5/6R8** A223
- SBH5/6R9E2** A223
- SBH5/6RC8E2** A223 A237
- SBH5/6RXE2** A223
- SBH5/6USC9E2** A223
- SBH5/6USCXE2** A223
- SBH5/6XE2** A202 A223
- SBH5/66** A223
- SBH5/67** A223
- SBH5/68** A223
- SBH5/69E2** A203 A223 C143
- SBN1/2** A226
- SBN1/26** A226
- SBN5/6** A226
- SC2R/2L** A222
- SC2R/2L6** A222
- SC2R/2L7** A222
- SC2R/2L8** A222
- SC2R/2L9E2** A222
- SC2R/2LC8E2** A222 A237
- SC2R/2LXE2** A222
- SC4R/4L** A222
- SC4R/4L6** A222 A606
- SC4R/4L7** A222
- SC4R/4L8** A222
- SC4R/4L9E2** A222 A716
C133
- SC4R/4LC8E2** A222 A237
- SC4R/4LG9E2** A222
- SC4R/4LXE2** A222
- SC13/14** A222 A904
- SC13/14C** A222
- SC13/14C8E2** A222 A237
- SC13/14G9E2** A222
- SC13/14KOT** A622
- SC13/14R** A222
- SC13/14R6** A222
- SC13/14R7** A222
- SC13/14R8** A222
- SC13/14SKO** A622
- SC13/14XE2** A202 A222
- SC13/146** A222 A902 A903
- SC13/147** A222
- SC13/148** A222
- SC13/149E2** A222 C132
C136 C144
- SCB1X** C219
- SCD-001** C221
- SCD-012** C221
- SCGC** A833 A906 A1002
- SCGCP** A603 A604 A833
- SCGS** A833
- SCHUSET** A606
- SCI1** A235
- SCI2/3** A235
- SCI2/36** A235
- SCI2/37** A235
- SCI16** A235
- SCK** C211
- SCK6** A235
- SCK66** A235
- SCL** C219
- SCL2** C220
- SCL322** C219
- SCL515** C219
- SCL816** C219
- SCL1015** C219
- SCL1215** C219
- SCL1218** C219
- SCL3222** C220
- SCL5152** C220
- SCL8162** C220
- SCL10152** C220
- SCL10172** C220
- SCL12152** C220
- SCL12182** C220
- SCM** C219
- SCM2** C220
- SCNEVI1** A228
- SCNEVI1C8E2** A228 A237
- SCNEVI1G9E2** A228
- SCNEVI1LPC9E2** A244
- SCNEVI1XE2** A228
- SCNEVI2** A229
- SCNEVI2C8E2** A229 A237
- SCNEVI2G9E2** A229
- SCNEVI2XE2** A229
- SCNEVI3C8E2** A229 A237
- SCNEVI3G9E2** A229
- SCNEVI3XE2** A202 A229
- SCNEVI4C8E2** A229 A237
- SCNEVI4E92** C144
- SCNEVI4G9E2** A229
- SCNEVI4L9E2** A229
- SCNEVI4LC8E2** A229
- SCNEVI4LG9E2** A229
- SCNEVI4LPC9E2** A244
- SCNEVI4LXE2** A229
- SCNEVI4XE2** A202 A229
- SCNEVI17** A228
- SCNEVI18** A228
- SCNEVI19E2** A228 C144
- SCNEVI27** A229
- SCNEVI28** A229
- SCNEVI29E2** A229 C143
C145
- SCNEVI39E2** A229 C144
- SCNEVI46** A229
- SCNEVI49E2** A229 C143
C144 C145
- SCORT** A833
- SCORTSC** A829
- SCQ** C219
- SCS** C219
- SCS2** C220
- SCS5** C219
- SCS25** C220
- SCU61** A243
- SCU62** A243
- SCW2** C220
- SCX** C219
- SCX2** C220
- SCXS** C219
- SCXS2** C220
- SCXX** C219
- SCXX2** C220
- SCZ** C219
- SDCM/D7** A243
- SDCN7** A243
- SDG-001** C225
- SDH100C8E2** A237 A241
- SDH1009E2** A241
- SDKCLIP** A302
- SDKGPLATE** A302
- SDKGPSCREW** A302
- SDKKIT** A302
- SDKSTCOARS** A302
- SDKSTONEA** A302
- SDKSTONEC** A302
- SDM16** A224
- SDM26** A224
- SDP5/6K** A243
- SDP9/11K** A243
- SG1/2** A207
- SG1/2C8E2** A237
- SG1/2C8E2** A207
- SG1/2G9E2** A207
- SG1/2PC9E2** A244 A245
- SG1/2R6** A207
- SG1/2R7** A207
- SG1/2R8** A207
- SG1/2R9E2** A207 A218
- SG1/2RC8** A237
- SG1/2RC8E2** A207
- SG1/2RXE2** A207
- SG1/2XE2** A202 A207
- SG1/26** A207
- SG1/27** A207
- SG1/28** A207
- SG1/29APE2** A215 C145
- SG1/29APXE2** A202
- SG1/29E2** A207 A904
- SG1/29LCE2** A217
- SG3/4** A207
- SG3/4C8E2** A207
- SG3/4R6** A207
- SG3/4R7** A207
- SG3/4R8** A207
- SG3/4R9E2** A207
- SG3/4RC8E2** A237
- SG3/4RC8E2** A207
- SG3/4RXE2** A207
- SG3/4XE2** A207
- SG3/46** A207
- SG3/47** A207
- SG3/48** A207
- SG3/49E2** A207
- SG5/6** A207
- SG5/6C8E2** A237
- SG5/6C8E2** A207
- SG5/6ER6** A207
- SG5/6ER7** A207
- SG5/6ER8** A207
- SG5/6G9E2** A207
- SG5/6R6** A207
- SG5/6R7** A207
- SG5/6R8** A207
- SG5/6R9E2** A207
- SG5/6RC8E2** A237
- SG5/6RC8E2** A207
- SG5/6RXE2** A207
- SG5/6XE2** A207
- SG5/67** A207
- SG5/68** A207
- SG5/69E2** A207
- SG7/8** A208
- SG7/8C8E2** A237
- SG7/8C8E2** A208
- SG7/8ER6** A208
- SG7/8ER7** A208
- SG7/8ER8** A208
- SG7/8G9E2** A208
- SG7/8PC9E2** A244 A245
- SG7/8R6** A208
- SG7/8R7** A208
- SG7/8R8** A208
- SG7/8R9E2** A208
- SG7/8RC8E2** A237
- SG7/8RC8E2** A208
- SG7/8RXE2** A208
- SG7/8XE2** A202 A208
- SG7/86** A208
- SG7/87** A208
- SG7/88** A208
- SG7/89APE2** A215 C145
- SG7/89E2** A208
- SG7/89LCE2** A217
- SG9/10** A208



- [SG9/10C8E2](#) A237
- [SG9/10C8E2](#) A208
- [SG9/10R6](#) A208
- [SG9/10R7](#) A208
- [SG9/10R8](#) A208
- [SG9/10R9E2](#) A208
- [SG9/10RXE2](#) A208
- [SG9/10XE2](#) A208
- [SG9/106](#) A208
- [SG9/107](#) A208
- [SG9/108](#) A208
- [SG9/109E2](#) A208
- [SG11/12](#) A208
- [SG11/12APXE2](#) A202
- [SG11/12C8E2](#) A237
- [SG11/12C8E2](#) A208
- [SG11/12ER6](#) A208
- [SG11/12ER7](#) A208
- [SG11/12ER8](#) A208
- [SG11/12G9E2](#) A208
- [SG11/12PC9E2](#) A244 A245
- [SG11/12R6](#) A208
- [SG11/12R7](#) A208
- [SG11/12R8](#) A208
- [SG11/12R9E2](#) A208
- [SG11/12RC8E2](#) A237
- [SG11/12RC8E2](#) A208
- [SG11/12RXE2](#) A208
- [SG11/12XE2](#) A202 A208
- [SG11/14](#) A209
- [SG11/14C8E2](#) A209 A237
- [SG11/14R](#) A209
- [SG11/14XE2](#) A209
- [SG11/126](#) A208 A708
- [SG11/127](#) A208
- [SG11/128](#) A208
- [SG11/129APE2](#) A215 C145
- [SG11/129E2](#) A203 A208 C132
- [SG11/129LCE2](#) A217
- [SG11/146](#) A209
- [SG11/147](#) A209
- [SG11/148](#) A209
- [SG11/149APE2](#) A215
- [SG11/149E2](#) A209
- [SG12/13](#) A209
- [SG12/13C8E2](#) A209 A237
- [SG12/13R](#) A209
- [SG12/13XE2](#) A209
- [SG12/136](#) A209
- [SG12/137](#) A209
- [SG12/138](#) A209
- [SG12/139APE2](#) A215
- [SG12/139E2](#) A209
- [SG13/14](#) A208
- [SG13/14C8E2](#) A237
- [SG13/14C8E2](#) A208
- [SG13/14ER6](#) A208
- [SG13/14ER7](#) A208
- [SG13/14ER8](#) A208
- [SG13/14G9E2](#) A208
- [SG13/14PC9E2](#) A244 A245
- [SG13/14R6](#) A208
- [SG13/14R7](#) A208
- [SG13/14R8](#) A208
- [SG13/14R9E2](#) A208
- [SG13/14RC8E2](#) A237
- [SG13/14RC8E2](#) A208
- [SG13/14RXE2](#) A208
- [SG13/14XE2](#) A202 A208
- [SG13/146](#) A208 A708
- [SG13/147](#) A208
- [SG13/148](#) A208
- [SG13/149APE2](#) A215 C145
- [SG13/149APXE2](#) A202
- [SG13/149E2](#) A203 A208 C132 C143
- [SG13/149LCE2](#) A217
- [SG15/16](#) A209
- [SG15/16C8E2](#) A209 A237
- [SG15/16ER6](#) A209
- [SG15/16ER8](#) A209
- [SG15/16G9E2](#) A209
- [SG15/16R6](#) A209
- [SG15/16R7](#) A209
- [SG15/16R8](#) A209
- [SG15/16R9E2](#) A209
- [SG15/16RC8E2](#) A209 A237
- [SG15/16RXE2](#) A209
- [SG15/16XE2](#) A209
- [SG15/166](#) A209
- [SG15/167](#) A209
- [SG15/168](#) A209
- [SG15/169E2](#) A209 C143 C145
- [SG17/18](#) A209
- [SG17/18C8E2](#) A209 A237
- [SG17/18G9E2](#) A209
- [SG17/18R6](#) A209
- [SG17/18R7](#) A209
- [SG17/18R8](#) A209
- [SG17/18R9E2](#) A209
- [SG17/18RC8E2](#) A209 A237
- [SG17/18RXE2](#) A209
- [SG17/18XE2](#) A202 A209
- [SG17/186](#) A209
- [SG17/187](#) A209
- [SG17/188](#) A209
- [SG17/189E2](#) A209 C143
- [SGC1/26](#) A216
- [SGC11/126](#) A216
- [SGC13/146](#) A216
- [SGCSUB-0](#) A716
- [SGCSUB-06](#) A216 A716
- [SGF16](#) A239
- [SGF21S/33](#) A239
- [SGF26](#) A239
- [SGF36](#) A239
- [SGF46](#) A239
- [SGF216](#) A239
- [SGR1/2R](#) A207
- [SGR3/4R](#) A207
- [SGR5/6R](#) A207
- [SGR7/8R](#) A208
- [SGR9/10R](#) A208
- [SGR11/12R](#) A208
- [SGR13/14R](#) A208
- [SGR15/16R](#) A209
- [SGR17/18R](#) A209
- [SGRT](#) A809
- [SGRTB](#) A809
- [SH3/4](#) A234
- [SH3/46](#) A234
- [SH5/33](#) A230 A1002
- [SH5/33C8E2](#) A230 A237
- [SH5/33G9E2](#) A230
- [SH5/33XE2](#) A230
- [SH5/336](#) A230
- [SH5/337](#) A230
- [SH5/338](#) A230
- [SH5/339E2](#) A230
- [SH5/U15](#) A230
- [SH5/U156](#) A230
- [SH6/7](#) A230
- [SH6/7C8E2](#) A230 A237
- [SH6/7G9E2](#) A230
- [SH6/7XE2](#) A202 A230
- [SH6/76](#) A230
- [SH6/77](#) A230
- [SH6/78](#) A230
- [SH6/79E2](#) A203 A230 C132 C133
- [SHAW1](#) A671
- [SHAW2](#) A671
- [SHAW3](#) A671
- [SHAW4](#) A671
- [SHAW7](#) A671
- [SHDPV](#) A716 A717 A719 A822 A902 A903 A904 A905 A919
- [SHG6/7](#) A231
- [SHG6/76](#) A231
- [SHG6/77](#) A231
- [SHG6/78](#) A231
- [SHG31/32](#) A227
- [SHTMBH](#) A822 A919
- [SI2](#) C222
- [SI3](#) C222
- [SI4](#) C222
- [SI6](#) C222
- [SINC1](#) A781 C139
- [SINC1S6](#) A781
- [SINC1SX](#) A781
- [SINC1X](#) A781
- [SINC2](#) A781 C139
- [SINC2S6](#) A781
- [SINC2SX](#) A781
- [SINC2X](#) A781
- [SIU13/14](#) A225
- [SIU13/146](#) A225
- [SIU17/18](#) A225 A904
- [SIU17/186](#) A225
- [SIU17/187](#) A225
- [SIU17/188](#) A225
- [SIUFW204](#) A233
- [SIUFW204C8E2](#) A233 A237
- [SIUFW204XE2](#) A233
- [SIUFW2046](#) A233
- [SIUFW2047](#) A233
- [SIUFW2048](#) A233
- [SIUFW2049E2](#) A233
- [SJ14/15](#) A234
- [SJ14/156](#) A234
- [SJ30/33](#) A234
- [SJ30/33C8E2](#) A234 A237
- [SJ30/33XE2](#) A234
- [SJ30/336](#) A234
- [SJ30/337](#) A234
- [SJ30/338](#) A234
- [SJ30/339E2](#) A234
- [SJ31/32](#) A234
- [SJ31/32C8E2](#) A234 A237
- [SJ31/32XE2](#) A234
- [SJ31/326](#) A234
- [SJ31/327](#) A234
- [SJ31/328](#) A234
- [SJ31/329E2](#) A234
- [SJ34/35](#) A234
- [SJ34/35C8E2](#) A234 A237
- [SJ34/35XE2](#) A234
- [SJ34/356](#) A234 A902
- [SJ34/357](#) A234
- [SJ34/358](#) A234
- [SJ34/359E2](#) A234
- [SJC](#) A833
- [SJOVANEKIT](#) A716
- [SJOVANKIT](#) A716
- [SJS](#) A833
- [SK8/9](#) A732
- [SK8/96](#) A732
- [SKN3/46](#) A732
- [SKN4](#) A905

- SKN46** A732
- SKRA16** A732
- SKRA26** A732
- SKRA36** A716 A732
- SKRA39** A732
- SL1/2AF6** A220
- SL1/2AF9E2** A220
- SL1/2C8E2** A220 A237
- SL1/2MF6** A220
- SL1/2MF9E2** A220
- SL1/2R6** A220
- SL1/2R7** A220
- SL1/2XE2** A220
- SL1/22** A220
- SL1/26** A220
- SL1/27** A220
- SL1/28** A220
- SL1/29E2** A220
- SL3/4AF9E2** A221 C143
- SL3/4C8E2** A221 A237
- SL3/4MF6** A221
- SL3/4MF9E2** A221
- SL3/4PC9E2** A245
- SL3/4R6** A221
- SL3/4R7** A221
- SL3/4XE2** A221
- SL3/42** A221
- SL3/46** A221
- SL3/47** A221
- SL3/48** A221
- SL3/49E2** A221 C145
- SL5/6AF6** A221
- SL5/6C8E2** A221 A237
- SL5/6MF6** A221
- SL5/6MF9E2** A221
- SL5/6R6** A221
- SL5/6XE2** A221
- SL5/66** A221
- SL5/67** A221
- SL5/68** A221
- SL5/69E2** A221
- SL17/18C8E2** A221 A237
- SL17/18R6** A221
- SL17/18XE2** A221
- SL17/186** A221
- SL17/187** A221
- SL17/188** A221
- SL17/189E2** A221
- SLB** A833
- SLL10/11R6** A225
- SLL10/11S8** A225
- SLL10/112** A225
- SLL10/116** A225
- SLL10/117** A225
- SLL10/118** A225
- SMO/00** A231
- SMO/00C8E2** A231 A237
- SMO/00G9E2** A231
- SMO/00XE2** A231
- SMO/006** A231
- SMO/007** A231
- SMO/008** A231
- SMO/009E2** A231
- SM11/12** A238
- SM11/12A** A238
- SM11/12A6** A238
- SM11/126** A238
- SM11/127** A238
- SM11/128** A238
- SM13/14** A238
- SM13/14C8E2** A237 A238
- SM13/14S** A238
- SM13/14S6** A238
- SM13/14S7** A238
- SM13/14S8** A238
- SM13/14S9E2** A238
- SM13/14SC8E2** A237 A238
- SM13/14SXE2** A238
- SM13/146** A238
- SM13/147** A238
- SM13/148** A238
- SM13/149E2** A238
- SM17/18** A239
- SM17/18C8E2** A237 A239
- SM17/18PT** A239
- SM17/18PT6** A239
- SM17/18PT9E2** A239
- SM17/18XE2** A202 A239
- SM17/186** A239 A718
- SM17/187** A239
- SM17/188** A239
- SM17/189E2** A239 C144
- SM23** A233
- SM23C8E2** A233
- SM23XE2** A233
- SM236** A233
- SM237** A233
- SM239E2** A233
- SMAL1/2** A227
- SMB** A832
- SME1** A226
- SMS1/2XE2** A214
- SMS1/29E2** A218
- SMS1/29E2** A214
- SMS7/8XE2** A214
- SMS7/89E2** A214
- SMS11/12XE2** A214
- SMS11/129E2** A214
- SMS13/14XE2** A214
- SMS13/149E2** A214
- SMTC13/146** A239
- SN2** C222
- SN3** C222
- SN4** C222
- SN6** C222
- SN128** A231
- SN128DE9E2** A231
- SN128DEC8E2** A231
- SN128DEG9E2** A231
- SN128DEXE2** A231
- SN128/NEV19E2** A231
- SN135C8E2** A233 A237
- SN135G9E2** A233
- SN135XE2** A233
- SN137C8E2** A231 A237
- SN137M6** A231
- SN137M7** A231
- SN137M8** A231
- SN137XE2** A231
- SN1286** A231
- SN1287** A231
- SN1288** A231
- SN1356** A233
- SN1357** A233
- SN1358** A233
- SN1359E2** A233
- SN1376** A231
- SN1377** A231
- SN1379E2** A231
- SNEV1/H5C8E2** A228 A237
- SNEV1/H5G9E2** A228
- SNEV1/H5XE2** A228
- SNEV1/H56** A228
- SNEV1/H57** A228
- SNEV1/H58** A228
- SNEV1/H59E2** A228
- SNLD1** A1018
- SNLD2** A1018
- SO6/7** A241
- SO6/76** A241
- SO8/9** A241
- SO8/96** A241
- SOUNDG** A606 A669
- SOUNDGS** A606 A669
- SP11/12RC8E2** A237
- SP13/14RC8E2** A237
- SP15/16RC8E2** A237
- SP20** A709 A717 A842
- SP20SLEM** A842
- SP6061** A635
- SP60616** A602 A603 A635
- SPAL13K6** A726
- SPAL13KS6** A726
- SPAL13KX** A726
- SPM20** A709 A842
- SPNHDPVN** A789
- SPP24GSICX** A805
- SPP24GSP2X** A805
- SPP24GSPX** A805
- SPPH2X** A805
- SPPSCHLEEX** A805
- SPR1/2** A732
- SPR1/2S** A732
- SPR1/2S6** A732
- SPR1/26** A709 A732
- SPR1/29** A732
- SPSPV** A834
- SPSPV45** A834
- SPT31** A666
- SPTPDAPV** A842
- SPTPDSSPV** A842
- SPV** A606 A713 A717 A719 A834 A905
- SPVX** A713 A834
- SQBL16** A224
- SQBL26** A224
- SQLL36** A224
- SQMD16** A224
- SQMD26** A224
- SR1** A811
- SR2** A811
- SR3** A811
- SR3/4** A227
- SR8** A809
- SR9** A809
- SR50** A809
- SRC3M** A810
- SRM3/4** A233
- SRM3/46** A233
- SRM10** A810 C139
- SRM15** A810
- SRMALO** A811
- SRP1/2R6** A210
- SRP1/2R7** A210
- SRP1/2R8** A210
- SRP1/2R9E2** A210
- SRP1/2RC8E2** A237
- SRP1/2RC8E2** A210
- SRP1/2RXE2** A210
- SRP3/4R6** A210
- SRP3/4R7** A210
- SRP3/4R8** A210
- SRP3/4R9E2** A210
- SRP3/4RC8E2** A237
- SRP3/4RC8E2** A210
- SRP3/4RXE2** A210
- SRP5/6E6** A210
- SRP5/6E7** A210
- SRP5/6E8** A210
- SRP5/6R6** A210

SRP5/6R7 A210
SRP5/6R8 A210
SRP5/6R9E2 A210
SRP5/6RC8E2 A237
SRP5/6RC8E2 A210
SRP5/6RXE2 A210
SRP7/8E6 A210
SRP7/8E7 A210
SRP7/8E8 A210
SRP7/8R6 A210
SRP7/8R7 A210
SRP7/8R8 A210
SRP7/8R9E2 A210
SRP7/8RC8E2 A237
SRP7/8RC8E2 A210
SRP7/8RXE2 A210
SRP11/12C8E2 A237
SRP11/12E6 A211
SRP11/12E7 A211
SRP11/12E8 A211
SRP11/12R6 A211
SRP11/12R7 A211
SRP11/12R8 A211
SRP11/12R9E2 A211
SRP11/12RC8E2 A211
SRP11/12RG9E2 A211
SRP11/12RXE2 A211
SRP13/14C8E2 A237
SRP13/14E6 A211
SRP13/14E7 A211
SRP13/14E8 A211
SRP13/14R6 A211
SRP13/14R7 A211
SRP13/14R8 A211
SRP13/14R9E2 A211 C144
SRP13/14RC8E2 A211
SRP13/14RXE2 A211
SRP15/16C8E2 A237
SRP15/16R6 A211
SRP15/16R7 A211
SRP15/16R8 A211
SRP15/16R9E2 A211 C144
SRP15/16RC8E2 A211
SRP15/16RXE2 A211
SRPG1/2 A210
SRPG1/2C8E2 A237
SRPG1/2C8E2 A210
SRPG1/2PC9E2 A245
SRPG1/2R A210
SRPG1/2XE2 A210
SRPG1/26 A210
SRPG1/27 A210
SRPG1/28 A210
SRPG1/29E2 A218
SRPG1/29E2 A210
SRPG3/4 A210
SRPG3/4C8E2 A237
SRPG3/4C8E2 A210
SRPG3/4R A210
SRPG3/4XE2 A210
SRPG3/46 A210
SRPG3/47 A210
SRPG3/48 A210
SRPG3/49E2 A210
SRPG5/6 A210
SRPG5/6C8E2 A237
SRPG5/6C8E2 A210
SRPG5/6R A210
SRPG5/6XE2 A210
SRPG5/66 A210
SRPG5/67 A210
SRPG5/68 A210
SRPG5/69E2 A210
SRPG7/8 A210
SRPG7/8C8E2 A237
SRPG7/8C8E2 A210
SRPG7/8R A210
SRPG7/8XE2 A210
SRPG7/86 A210
SRPG7/87 A210
SRPG7/88 A210
SRPG7/89E2 A210 C133 C143
SRPG11/12 A211
SRPG11/12C8E2 A211
SRPG11/12G9E2 A211
SRPG11/12R A211
SRPG11/12XE2 A202 A211
SRPG11/14 A211
SRPG11/14C8E2 A211
SRPG11/14XE2 A211
SRPG11/126 A211
SRPG11/127 A211
SRPG11/128 A211
SRPG11/129E2 A211 C133
SRPG11/146 A211
SRPG11/147 A211
SRPG11/149E2 A211
SRPG12/13 A211
SRPG12/13C8E2 A211
SRPG12/13XE2 A211
SRPG12/136 A211
SRPG12/137 A211
SRPG12/138 A211
SRPG12/139E2 A211
SRPG13/14 A211
SRPG13/14C8E2 A211
SRPG13/14R A211
SRPG13/14XE2 A202 A211
SRPG13/146 A211
SRPG13/147 A211
SRPG13/148 A211
SRPG13/149E2 A211 C133
SRPG13/149E2 C143 C144
SRPG15/16 A211
SRPG15/16C8E2 A211
SRPG15/16PC9E2 A245
SRPG15/16R A211
SRPG15/16XE2 A202 A211
SRPG15/166 A211
SRPG15/167 A211
SRPG15/168 A211
SRPG15/169E2 A211 C143
SRPG15/169E2 C144
SS1/2RC8E2 A237
SS2 A305
SS3/4RC8E2 A237
SS3C A306 C132 C133
SS4 A305
SS5 A305
SS5/6 A732
SS5/6RC8E2 A237
SS5/66 A732
SS6 A306
SS6A A305
SS7/8RC8E2 A237
SS9/10 A732
SS9/106 A732
SS11/12 A732
SS11/12RC8E2 A237
SS11/126 A732
SS13/14RC8E2 A237
SS15/16RC8E2 A237
SS299 A305 A706
SS300 A307
SS301 A307
SS302 A307
SS303 A307
SS304 A307
SS305 A307
SS309 A306
SSAS22 A305
SSC-6LL2 A657
SSC-6LL3 A657
SSC-6LL4 A657
SSC-6LL5 A657
SSC-6LL6 A657
SSC-6LL7 A657
SSC-6LR2 A657
SSC-6LR3 A657
SSC-6LR4 A657
SSC-6LR5 A657
SSC-6LR6 A657
SSC-6LR7 A657
SSC-6UL2 A657
SSC-6UL3 A657
SSC-6UL4 A657
SSC-6UL5 A657
SSC-6UL6 A657
SSC-6UL7 A657
SSC-6UR2 A657
SSC-6UR3 A657
SSC-6UR4 A657
SSC-6UR5 A657
SSC-6UR6 A657
SSC-6UR7 A657
SSC-KIT A655
SSC-LLD2 A656
SSC-LLD3 A656
SSC-LLD4 A656
SSC-LLD5 A656
SSC-LLD6 A656
SSC-LLD7 A656
SSC-LLE2 A656
SSC-LLE3 A656
SSC-LLE4 A656
SSC-LLE5 A656
SSC-LLE6 A656
SSC-LLE7 A656
SSC-LRD2 A656
SSC-LRD3 A656
SSC-LRD4 A656
SSC-LRD5 A656
SSC-LRD6 A656
SSC-LRD7 A656
SSC-LRE2 A656
SSC-LRE3 A656
SSC-LRE4 A656
SSC-LRE5 A656
SSC-LRE6 A656
SSC-LRE7 A656
SSC-PKIT A657
SSC-PKITM A657
SSC-PTRAY A657
SSCROWNKIT A603
SSC-TRAY A655
SSC-ULD2 A656
SSC-ULD3 A656
SSC-ULD4 A656
SSC-ULD5 A656
SSC-ULD6 A656
SSC-ULD7 A656
SSC-ULE2 A656
SSC-ULE3 A656
SSC-ULE4 A656
SSC-ULE5 A656
SSC-ULE6 A656
SSC-ULE7 A656
SSC-URD2 A656
SSC-URD3 A656
SSC-URD4 A656

SSC-URD5 A656
SSC-URD6 A656
SSC-URD7 A656
SSC-URE2 A656
SSC-URE3 A656
SSC-URE4 A656
SSC-URE5 A656
SSC-URE6 A656
SSC-URE7 A656
SSDGRIT A306
SSF1 A306
SSGO C119
SSG1 C119
SSG2 C119
SSG3 C119
SSG4 C119
SSG5 C119
SSG6 C119
SSG7 C119
SSG8 C119
SSG9 C119
SSG10 C119
SSG11 C119
SSG12 C119
SSGBLUE8 C119
SSGGRAY8 C119
SSGGREEN8 C119
SSGLAVNDR8 C119
SSGMULTI C119
SSGORANGE8 C119
SSGPURPLE8 C119
SSGRED8 C119
SSGYELLOW8 C119
SSI-100 C211
SSI-1000 C211
SSKC A306 A715 A739
SSKITA A305
SSKITC A306
SSLUX A306 A707 A742
SSMS22 A306
SSO A305 A308
SSP1 A232
SSP2/3 A233
SSP2/36 A233
SSP16 A232
SSPR1 A779
ST2/3 A233
ST2/36 A233
ST2/37 A233
ST2/38 A233
STEIGKIT A717
STLF18MM C213
STLF24MM C213
STMBH A834
STP-025 C211

SU15/30 A230
SU15/30C8E2 A230 A237
SU15/30G9E2 A230
SU15/30XE2 A230
SU15/33 A230
SU15/33C8E2 A230 A237
SU15/33G9E2 A230
SU15/33XE2 A230
SU15/306 A230
SU15/307 A230
SU15/308 A230
SU15/309E2 A230
SU15/336 A230
SU15/337 A230
SU15/338 A230
SU15/339E2 A230
SU151 A230
SU156 A230
SU157 A230
SU158 A230
SUCR3/4XE2 A226
SUCR3/46 A226
SUCR3/48 A226
SUCR3/49E2 A226
SUSC128 A232
SUSC1286 A232
SUZUKIKIT A718
SW12 C217
SW15 C217
SW18 C217
SW20 C217
SW24 C217
SW30 C217
SW36 C217
SWH2 A232
SYBG A712 A838 C139
SYG7/8 A225
SYG7/8C8E2 A225 A237
SYG7/8G9E2 A225
SYG7/8PC9E2 A244 A245
SYG7/8XE2 A225
SYG7/86 A225
SYG7/87 A225
SYG7/88 A225
SYG7/89E2 A225 A717
SYG15 A232
SYG156 A232
SYRA A718 A838
SYRCW C141
SYRCW A716 A717 A838
 A906 C131 C134
 C135 C136 C137
 C138 C142
SYRCWE A905

T

TABANELLA1 A777
TABANELLA2 A748 A777
TABANELLA3 A728
TABANELLA4 A728
TBARREF A669
TC3 A849
TC5 A849
TFB A847
TFS A847
TK018 A1019
TK020S A1019
TKN1 A785
TKN1CH A785
TKN1S6 A785
TKN1SX A785
TKN1X A785
TKN2 A785
TKN2CH A785
TKN2S6 A785
TKN2SX A785
TKN2X A785
TKSTEIG A717 A785
TKSTEIG2 A717 A785
TNANTKIT A607
TNBB18 A650
TNBB21B A650
TNBB27/29 A602 A649
TNBBL2 A650
TNBBL3 A650
TNBBS/M A650
TNCALIBRA A615
TNCCIA A613
TNCCIB A604 A613
TNCCIC A613
TNCCID A613
TNCCIE A613
TNCCIF A614
TNCCIG A614
TNCCIH A614
TNCCII A614
TNCFIM/L A607
TNCFIR/L A612
TNCFIS/M A607
TNCIGFT1 A602 A610 A906
TNCIGFT2 A610 C131 C134
 C137
TNCIGFT3 A602 A607 A610
 C131 C134
TNCIGFT4 A611
TNCIGFT5 A611
TNCIGFT6 A611
TNCIGFTM1 A603 A607
 A611
TNCIGFTM3 A611
TNCIGFTM4 A604 A611
TNCIPAOX A605 A615
TNCIPCL A607 A615
TNCIPCM A607 A615
TNCIPCS A607 A611
TNCVIPC A602 A646 C131
 C134
TNCVIPCL A646
TNCVKR1 A623
TNEXBKR1 A622
TNEXBKR1X A605 A615
TNFCIL A613
TNFCIS A603 A613
TNFF1/2 A604 A614
TNFF3/4 A604 A614
TNFF5/6 A604 A614
TNFF7/8 A604 A614
TNFFCASS A604
TNGMPI A602 A611 A635
TNMASS1 A605
TNMASS1 A623
TNMASS2 A605
TNMASS2 A623
TNPCCI A650
TNPF18A A612 A904
TNPFIA6 A612
TNPFIAB1 A612
TNPFIAB2 A612
TNPFIG4/5 A602 A612
TNPFIW3 A612
TNPLGOT A607
TNPLG5A A607
TNPLGH3 A607
TNPOSKIT A607
TNTAM1 A606 A614
TNTAM2 A606 A614
TNTAM3 A606 A614
TNTAMKIT A606
TP16 A839
TP31 A839
TP32 A605 A839
TP33 A839
TP34 A839
TP41 A840
TP42 A904 C141 C142
TP42 A840
TP43 A710 A711 A716 A718
 A840
TP43A A840
TP50 A840
TP50L A840 A905
TP5041 A844

TP5042 A844
TP5043 A710 A844
TP5050 A845
TP5051 A845
TP5060 A845
TP5061 A845
TP5062 A845
TP5070 A716 A846
TP5071 A846
TP5072 A846 A902 A903
TP5080 A846
TP5090 A712 A716 A718
 A719 A846
TP5091 A718 A846
TPA A839
TPA15 A840
TPAFB A402
TPAFC A402
TPAFEZ A403
TPASC A402
TPASEZ A403
TPASFC1 A403
TPASFC5 A403
TPASSC1 A403
TPASSC5 A403
TPASTMBH A843 A904
TPATB A402
TPATBC1 A403
TPBR A642
TPCSTMBH A844
TPDAPV A843 A905
TPDSCPV A843 A905
TPDSSPV A843 A905
TPG1 A840
TPG3 A841
TPG4 A841
TPH A642
TPKN A841
TPLUSPAFC A404
TPLUSPASC A404
TPLUSPATB A404
TPMSA A841
TPP A642
TPR6 A841
TPR8 A841
TPSLASCHLE A717 A843
TPSLCOCMN A843 A905
TPSLCOSM A716 A717
 A718 A719
 A844 A903
TPSLSSCHLE A844
TPSSTMBH A844
TPT A642
TPTH A642
TPXT A642

TPXXT A642
TRA2 A811
TRFB A808
TRH1 A810 A905
TRH2 A810
TRH2/3 A810
TRH3 A810
TUCKERKIT A607
TWLA A1019

U

UBLKORING B311
UCL-010 C225
UCL-010-R C225
UE1D B208
UE2LD B208
UE2RD B209
UE100 B208
UEP B208
UEP3 B208
UEP10 B208
UES10 B208
UFVBG A408
UFVCA A408
UFVCY A408
UFVM A408
UFVML A408
UGRNORING B311
UI25K100S B308 B313
UI25KP10 B308 B313
UI25KP10P B308 B313
UI25KSF10L B309
UI25KSF10R B309
UI25KSF10S B309
UI25KSFSET B309
UI25KSL10L B309 B313
UI25KSL10R B309 B313
UI25KSL10S B309 B313
UI25KSLSET B309 B313
UI25SD10 B304 B313
UI25SD100 B304 B313
UI25SD1000 B304 B313
UI25SDL B305 B313
UI25SDR B303 B305 B313
UI25SDS B305 B313
UI25SDSET B305 B313
UI25SDXTTB B313
UI25SF10 B309
UI25SF100 B309
UI25SF1000 B309
UI25SFL B309 B310
UI25SFR B309
UI25SFSET B310

UI25SS10 B306 B313
UI25SS100 B306 B313
UI25SS1000 B306 B313
UI25SSXT B306 B313
UI30K100S B313
UI30K100SX B308
UI30KP10 B308 B313
UI30KP10P B308 B313
UI30KSF10L B309
UI30KSF10R B309
UI30KSF10S B309
UI30KSFSET B309
UI30KSL10L B309 B313
UI30KSL10R B309 B313
UI30KSL10S B309 B313
UI30KSLSET B309 B313
UI30PPSB B306
UI30PPSC B306
UI30PPTB B306
UI30PPTC B306
UI30SD10 B304 B313
UI30SD100 B304 B313
UI30SDL B305 B313
UI30SDR B303 B305 B313
UI30SDS B305 B313
UI30SDSET B305 B313
UI30SDXTTB B305 B313
UI30SF10 B309 B313
UI30SF100 B309 B313
UI30SF1000 B309 B313
UI30SFL B309 B310 B313
UI30SFR B309 B313
UI30SFS B313
UI30SFSET B310 B313
UI30SFXT B310
UI30SFXTTB B310 B313
UI30SP10 B310
UI30SP100 B310
UI30SP1000 B310
UI30SPL B311
UI30SPR B311
UI30SPS B311
UI30SPXTTB B311
UI30SS10 B306 B313
UI30SS100 B306 B313
UI30SS1000 B306 B313
UI30SSXT B306 B313
UI325K B308 B313
UI330K B313
UI330KX B308
UIH025K B308 B313
UIH030K B313
UIH030KX B308
UIH00025K B308 B313

UIH00030K B313
UIH00030KX B308
UPBTL B203
UPBTLCAPGY B203
UPC12 A406
UPCA A406
UPCB A406
UPCBG A406
UPCCH A406
UPCM A406
UPCOV A406
UPER1 B206 B207 B213
UPER2 B206 B207 B213
UPER3 B206 B207 B213
UPER4 B206 B207 B213
UPER5 B206 B207 B213
UPFBG A406
UPFTPEDAL B203
UPHPLED B203
UPIC1 B205 B207 B213
UPICTH B205 B207 B213
UPK10 B203 B207
UPMA A406
UPMB A406
UPMBG A406
UPMCH A406
UPMM A406
UPMOV A406
UPORING B203
UPP2 B207
UPP2 B207 B213
UPP3 B203 B207 B213
UPP10 B207 B213
UPP11 B207 B213
UPP12 B207 B213
UPP13 B207 B213
UPP14 B207 B213
UPP15 B207 B213
UPP16L B207 B213
UPP16R B207 B213
UPPIEZO B202
UPPUMP B203
UPRD3 B206 B213
UPRD4 B206 B213
UPRD5 B206 B213
UPS1 B204 B207 B213
UPS1S B204
UPS1S B203 B213
UPS2 B204 B207 B213
UPS3 B204
UPS3 B207 B213
UPS4 B204
UPS4 B207 B213
UPS5 B204 B207 B213
UPSETER B207

UPSETIC B207
UPSETM B207
UPSETPM B207
UPSETPT B207
UPSETS B207
UPSFCC A407
UPSFCF A407
UPSFCS A407
UPSFCWC A407
UPSFMC A407
UPSFMF A407
UPSFMS A407
UPSFMWC A407
URBANGSKIT A718
URBANSLKIT A719
US1D B208 B213
US2LD B208 B213
US2RD B209 B213
US4L B209 B213
US4R B209 B213
US100 B208 B213
USAFL B209 B213
USAFR B209 B213
USAFS B209 B213
USP B208 B213
USP3 B208 B213
USP10 B208 B213
USRTW B208
USS10 B208 B213
USU B208 B213

V

VC-001 C210
VENSTAB A607 A662
VENSTABS A607 A662

W

W3D1930BL F503
W3D1930WH F503
WAPPCPROPHY B103
WBI-M/R A1019
WCS A851
WCSS A851
WEPBAQ F506
WEPBBL F506
WEPBDR F506
WEPBGR F506
WEPBLV F506
WEPBPE F506
WEPBSI F506
WEPBWH F506
WEPBYE F506
WERUEC F504
WERUECBL F504
WERUECDR F504
WERUECGR F504
WEXAQ F505
WEXBG F505
WEXBL F505
WEXBLT F502
WEXDR F505
WEXDRT F502
WEXFP F505
WEXGR F505
WEXLV F505
WEXLVT F502
WEXPE F505
WEXPP F505
WEXSI F505
WEXTB F505
WEXWH F505
WEXWHT F502
WEXYE F505
WGXBL F503
WGXWH F503
WPAB A850
WPXAQ F503
WPXBG F503
WPXBL F503
WPXBLT F502
WPXDR F503
WPXDRT F502
WPXFP F503
WPXGR F503
WPXLV F503
WPXPE F503
WPXSI F503
WPXTB F503
WPXWH F503
WPXWHT F502
WPXYE F503
WS7 A603 A665
WT5BL F507
WT5WH F507
WTXAQ F507
WTXBG F507
WTXBL F507
WTXDR F507
WTXFP F507
WTXGR F507
WTXSI F507
WTXWH F507
WTXYE F507
WUXBL F505
WUXWH F505
WUXYE F505

X

X23/PS36 A110
XP3A/NC156 A117 A718
XP3A/UNC15 A117
XP6/OW A116
XP6/OW6 A116
XP6/W A116
XP6/W6 A116
XP17/OW A116
XP17/OW6 A116
XP17/PH6 A117
XP20FQOW A117
XP20F/QOW6 A117
XP23/8 A115
XP23/11 A115
XP23/11.5B A115
XP23/11.56 A115
XP23/11.57 A115
XP23/11.58 A115
XP23/12 A116
XP23/86 A115 A712
XP23/116 A115
XP23/126 A116 C131
XP23/127 A116
XP23/128 A116
XP23/GF A117
XP23/GF6 A117
XP23/NC126 A116
XP23/NC127 A116
XP23/NC128 A116
XP23/O A117
XP23/O6 A117
XP23/OW A117
XP23/OW6 A117
XP23/PH6 A117
XP23/QOW A115
XP23/QOW6 A115 A708
XP23/QOW7 A115 A718
XP23/QOW8 A115
XP23/QW A115
XP23/QW6 A115 A716
XP23/UNC6 A116
XP23/UNC7 A116
XP23/UNC8 A116
XP23/UNC12 A116
XP23/UNC15 A116 A904
XP23/W A116
XP23/W6 A116
XP23/W7 A116
XP23/W8 A116
XPNT3 A116
XPNT36 A116
XPTU17/15 A116

XPTU17/156 A116
XPTU17/PH6 A117

Y

YFTHL A409
YFTHM A409
YFTHS A409

Z

ZCB F306
ZCMC F306
ZCW F306
ZCWCP F305
ZES50 F303
ZET F303
ZETMVL F303
ZETMVGR F303
ZETMVLV F303
ZETMVP F303
ZETMVPK F303
ZETMYE F303
ZETNV F303
ZFF F306
ZFFAD-100 F306
ZPP F306
ZWGCPM F305
ZWPCPBG F305
ZWW F306
ZWWCP F305

The Best In Practice

